

Multimedia im Netz

Wintersemester 2012/2013

Part IV

Conversational Multimedia Services

Outline

- | | | |
|-----|---|---|
| 1. | Introduction and Motivation | |
| 2. | Interactive Web Applications | Part I:
Web Technologies
for Interactive MM |
| 3. | Web Programming with Java | |
| 4. | Communities, the Web, and Multimedia | |
| 5. | Digital Rights Management | |
| 6. | Cryptographic Techniques | Part II:
Content-Oriented
Base Technologies |
| 7. | Multimedia Content Description | |
| 8. | Electronic Books and Magazines | |
| 9. | Multimedia Content Production and Management | Part III:
Multimedia
Distribution
Services |
| 10. | Streaming Architectures | |
| 11. | Web Radio, Web TV and IPTV | |
| 12. | Multimedia Conferencing | Part IV:
Conversational
Multimedia Services |
| 13. | Signaling Protocols for
Multimedia Communication | |
| 14. | Visions and Outlook | |

12 Multimedia Conferencing

12.1 Multimedia Conferencing: Service Definition and Equipment

12.2 Application Examples

12.3 Typology of Multi-Point Conferences

12.4 Standards for Multimedia Conferencing

Literature:

James R. Wilcox: Videoconferencing, the whole picture, 3rd ed,
CMP Media 2000

John Rhodes: Videoconferencing for the Real World,
Focal Press 2001

Scott Firestone et al.: Voice and Video Conferencing Fundamentals,
Cisco Press 2007

Videoconferencing: Definition

- Multimedia conferencing:
 - The *synchronous* exchange of digitized multimedia information (e.g. video, audio, images) between conference participants at two or more separate sites
 - Transferred images:
 - » Pictures of the participants
 - » Video clips, still pictures and other accompanying material in digitized form
 - » Screen or window content
 - Transferred sound:
 - » Discussions between meeting participants
 - » Sound from accompanying material (sound or video clips)
- Group-system videoconferencing: Joins two groups of people meeting in physically separate rooms
- Personal videoconferencing: Joins individual users (desktops, phones)
- Two sites (*point-to-point*) or more (*multi-point*)

An Old Dream: Video Conferencing in Movies



Metropolis, 1927



Star Trek, 1970s



2001: A Space Odyssey, 1968

Fritz Lang: Metropolis (1927)



Stanley Kubrick: 2001 – A Space Odyssey



History of Videoconferencing

- Bell Labs, 1920s: First videoconference between Washington and New York
- Bell Labs, 1940s: Videoconference research resumed
- Bell Labs, 1964: Picturephone.
 - Other pioneers, 1970s: NEC, British Telecom (1979)
- 1983: Compression of video signal to phone line bandwidth: Widcom project (DARPA)
- 1984: PictureTel, first software-based videoconferencing system (224 Kbps)
- 1994: Intel ProShare system (two ISDN B-channels)
- 1996: Standards H.323 and H.324, including H.263 compression
- 1996 until today: Trend to use IP data network technology instead of ISDN



Picturephone Mod 1

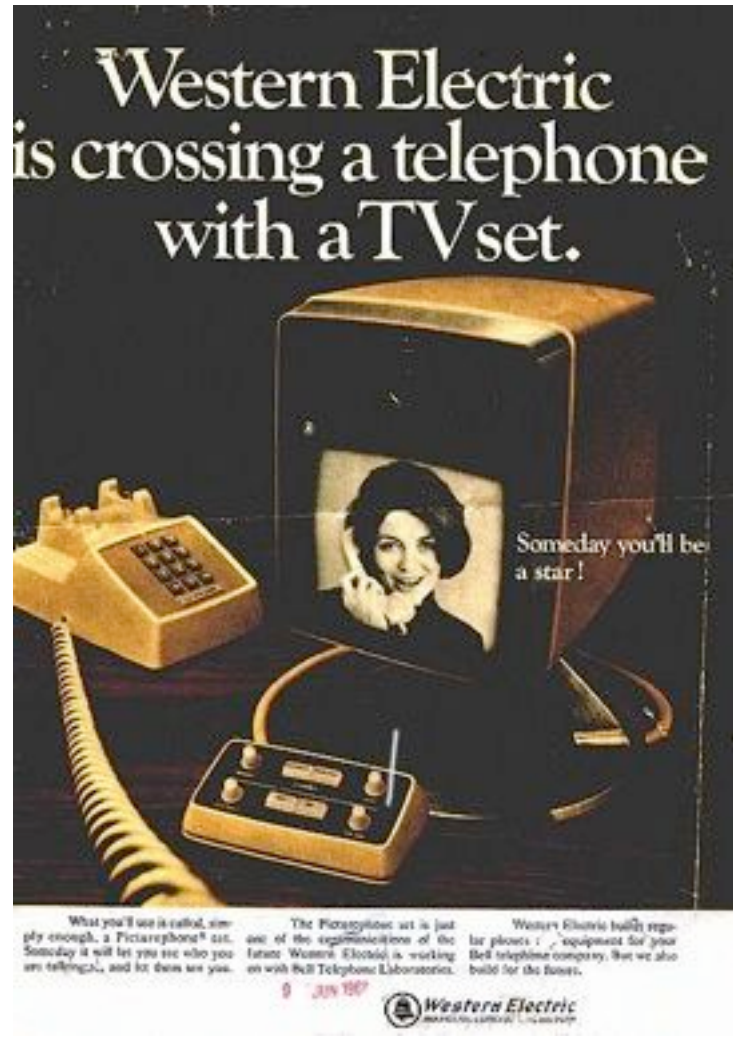

System Type I: Picturephones

- Telephone sets enhanced by video display and small camera
- Available on the market already for significant time
 - E.g. for ISDN



Pictures: Aethra

System Type II: Desktop Systems

- Desktop videoconferencing systems
 - PC with small camera mounted above the monitor
 - “Picture phone” on PC basis
 - Optimal for *application sharing*
- Disadvantages:
 - Usable only by a person a time
 - Limited picture and sound quality
- Cost 2001: 500 – 2000 € plus PC
- Cost now: Very low (often built in)
- Pure software solutions:
 - Simple standard systems like Ekiga, Apple FaceTime, Microsoft Skype
 - Sophisticated specialized software with dedicated servers/online service (e.g. Microsoft Office LifeMeeting)



Pictures: VCON, Apple, LifeSize

System Type III: Set-Top Systems

- Small box containing camera, microphone, speakers, codec, network interface, ...
 - To be put on top of TV set or monitor
- Simple, easy to use, targeted also to computer-illiterate users
- Disadvantage:
 - “Vendor lock-in”:
Upgrades are often difficult
- Cost: 3000 – 9000 €



Picture: LifeSize (Team 220)

System Type IV: Rollabout Systems

- Movable, medium-sized unit, often a rolling cabinet, containing
 - High-quality audio, video and telecommunication systems
 - One or two large monitors
 - Remotely controllable camera
- Optimal for small groups (three to six people)
- Cost: 10.000 – 20.000 €



Pictures:
xtelesis,
Tandberg

System Type V: Room Systems

- Room custom-equipped for conferencing requirements
- Possibly many cameras and monitors
- Furniture well integrated with conferencing equipment (cameras, monitors)
- High-quality sound system
- Cost: 30.000 – 1.000.000 €



HP Halo System
(www.telepresenceoptions.com)

Video Conference Room Design

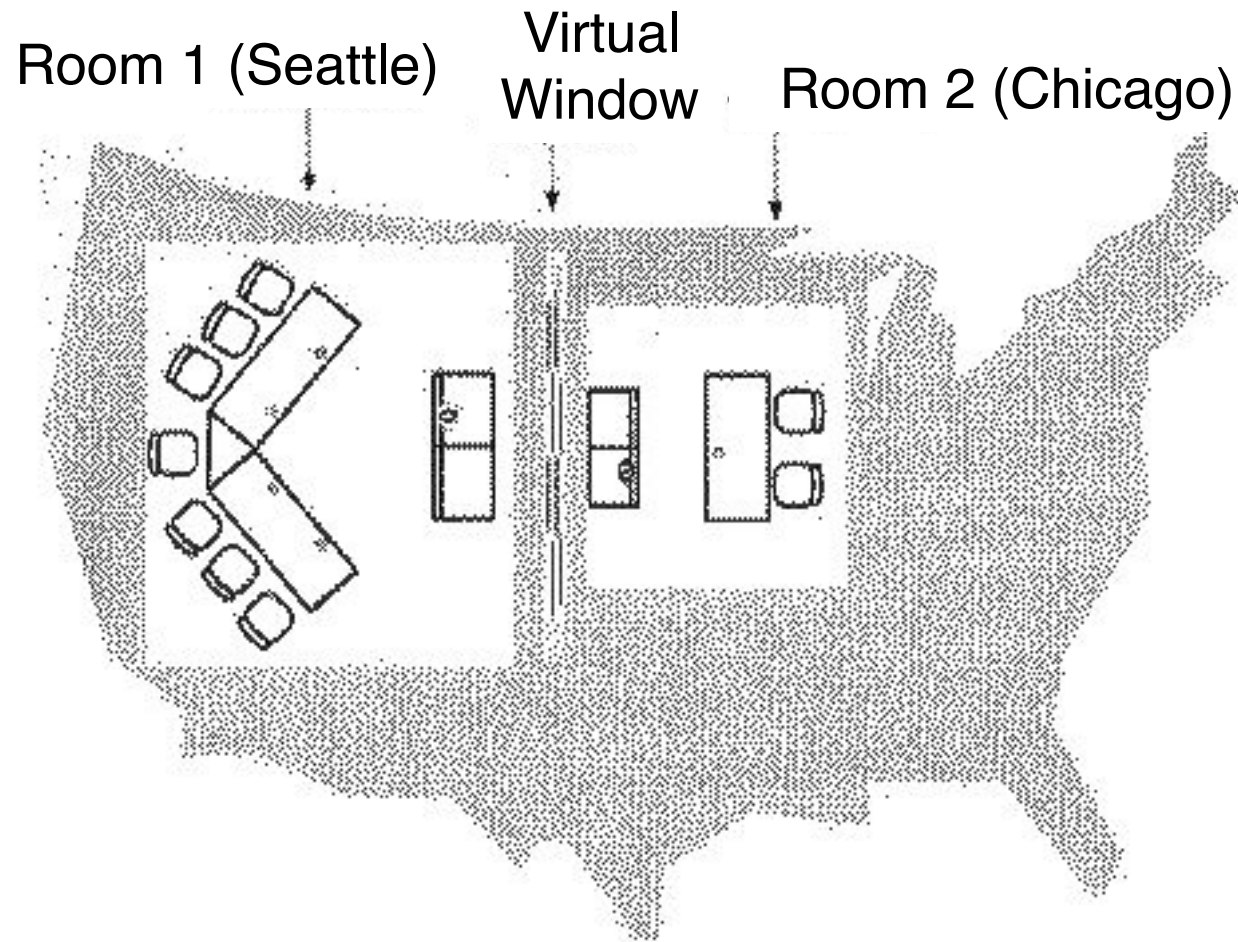

Figure 4-9 Two distant VTC rooms separated only by a virtual window.

Source:
Rhodes p. 79

System Type VI: Handheld Systems

- Videoconferencing clients running on mobile devices
 - Smartphones
 - Tablets
 - E.g. as apps for iOS or Android
- Examples: Apple FaceTime, LifeSize ClearSea client
- Cost: Very low cost + subscription (in some cases)



Pictures: Mirial/LifeSize

Camera Control

- Far-end camera control:
 - Participant or operator in room A allowed to control camera in room B
 - Useful when untrained people in room B
 - Mainly for point-to-point conferences
 - Standards exist (e.g. H.281/H.224 and H.323 V 5 Appendix Q, 2003)
- Camera presets:
 - Angles to view individual participants and other perspectives are pre-programmed before conference starts
 - Camera can be moved with a single key press, e.g. to show a specific participant
- Follow-me function:
 - Camera movement automatically synchronized with room or speaker microphones
 - Camera snaps into position for current speaker

Copy-Stand Camera

- Typical accessory of videoconference rooms



Echo and Feedback

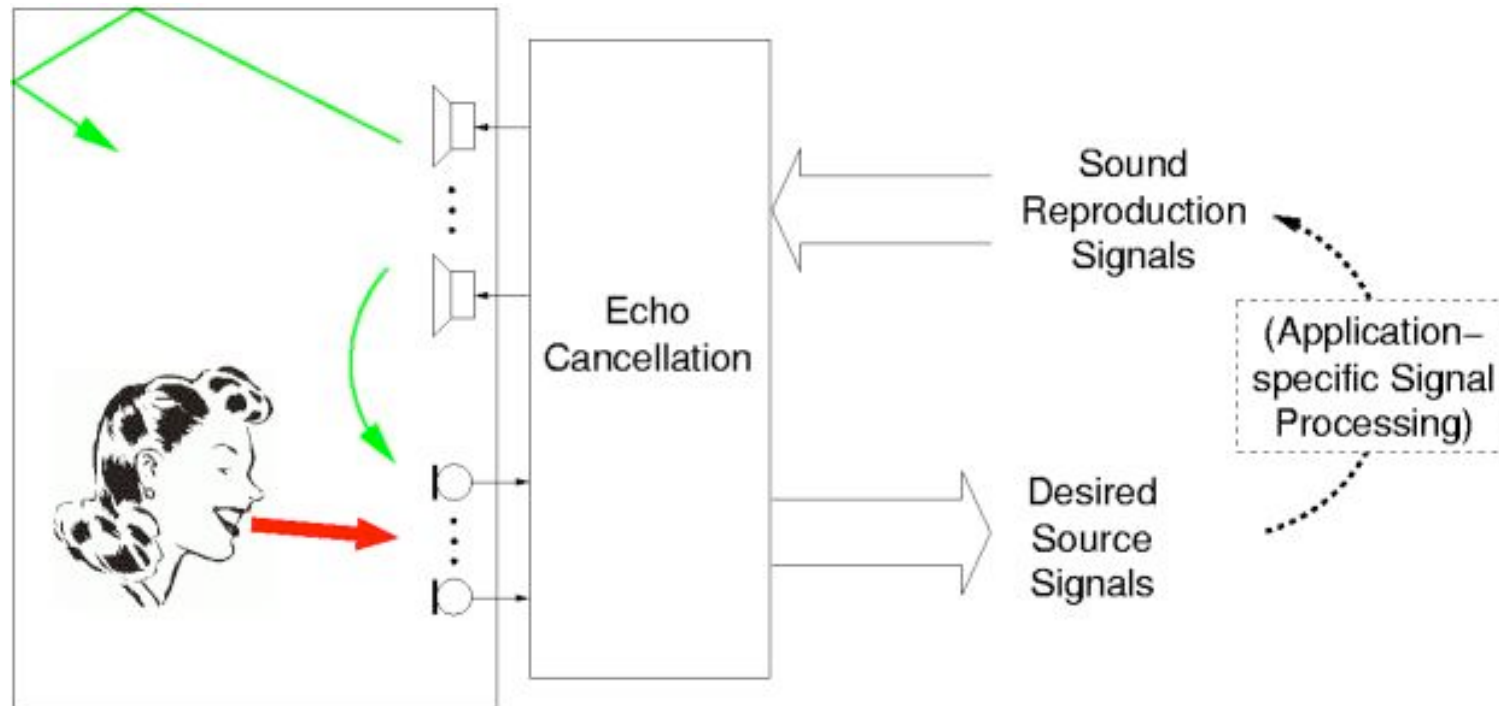

Picture:
Uni Erlangen

- Hands-free conference:
 - Feedback of own and foreign sound signals through loudspeaker into microphone
 - Various sources for delays
- Solutions: Cancellation in software, special microphones, headsets

Videoconferencing as Cloud Service

- Cloud resources:
 - Hardware (conference bridges)
 - Codecs (transcoding)
 - Directory services
- Simple clients
- No proprietary server needed
- Service paid per use
 - Subscription systems



Images: 8x8, LiveSize

12 Multimedia Conferencing

12.1 Multimedia Conferencing:
Service Definition and Equipment

12.2 Application Examples

12.3 Typology of Multi-Point Conferences

12.4 Standards for Multimedia Conferencing

Literature:

James R. Wilcox: Videoconferencing, the whole picture, 3rd ed,
CMP Media 2000

John Rhodes: Videoconferencing for the Real World,
Focal Press 2001

Application: PARC Media Spaces

- Xerox PARC System Concepts Laboratory, mid 1980-s
 - Geographical split between Palo Alto/California and Portland/Oregon
 - To maintain a single group and explore technologies for collaborative work
- Offices and meeting rooms connected by audio/video links
 - Local panels to configure connection configuration
- Positive effects:
 - *Awareness* of remote situation (e.g. presence of people at remote site)
 - Enabling informal encounters across sites
- Problems:
 - Boundaries of personal and private space
 - Integration into daily work life
 - » Placement of communication devices
 - » Integration into work flow and daily routine



Application: Preventing Nuclear Destruction

- Videoconference technology helped to protect the world during the year 2000 date rollover
 - To avoid control problems of nuclear power stations
 - Videoconference link between
 - » Emergency Center of the U.S. Department of Energy (Washington)
 - » Situation and Crisis Center of MinAtom (Moscow)
 - Expert exchange: Experts of the remote side present locally
- T1 line (24 phone lines bandwidth), off-the-shelf video codecs, LCD projectors etc.
- Newly developed (UNIX-based) video transmission software

Application: Distance Learning

- Lectures transmitted to remote students
 - Training of staff in businesses
 - Home-learning
- Integration of remote guest speakers in meetings



www.sllboces.org

Application: Telemedicine

(According to Wilcox, p. 37)

- Remote consultation of medical specialists
 - Military health care for patients on remote bases
 - Health care services for prison inmates
 - Rapid emergency response
 - Specialist support during critical operations
- Visiting nurses video-consulting with patients
 - Allows reduction of physical visits
- Additional data:
 - Pictures:
X-ray, tomography, ...
 - Lab results
 - Current vital data



Pictures: Radvision

12 Multimedia Conferencing

12.1 Multimedia Conferencing:
Service Definition and Equipment

12.2 Application Examples

12.3 Typology of Multi-Point Conferences

12.4 Standards for Multimedia Conferencing

Literature:

James R. Wilcox: Videoconferencing, the whole picture, 3rd ed,
CMP Media 2000

John Rhodes: Videoconferencing for the Real World,
Focal Press 2001

Meet-Me Conference

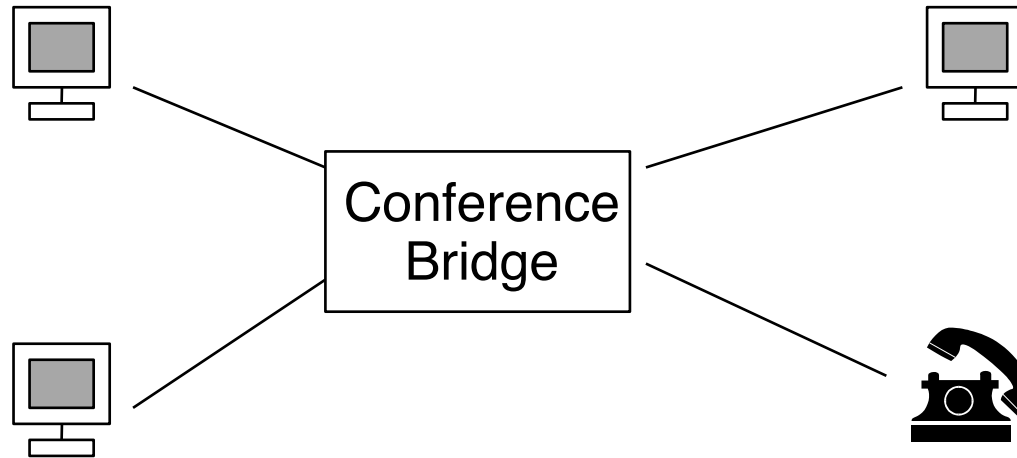

- Conference is pre-arranged
 - Time and address of bridge are known to participants
- Participants call the bridge to enter the conference
 - Bridge may also call out to participants
- Central conference bridge is a resource owned by a network or service provider
 - Mixes and distributes audio and video signals
- Examples: Telephone conference services, Skype conference call

Ad-Hoc Conference

- Conference starts as a point-to-point conversation
- Grows to a multi-point conference when participants *invite* other people by calling their terminals
- Conference is usually not pre-arranged
- Example: Three-way call in ISDN/private telephone exchanges
 - A talks to B
 - A puts B *on hold*
 - A calls C
 - A joins B and C into a three-way call
- User originating the conference call must be able to provide the necessary bridge functionality
 - Bridge outside the public network, e.g. in a private network
 - Capacity limited (e.g. in number of participants)

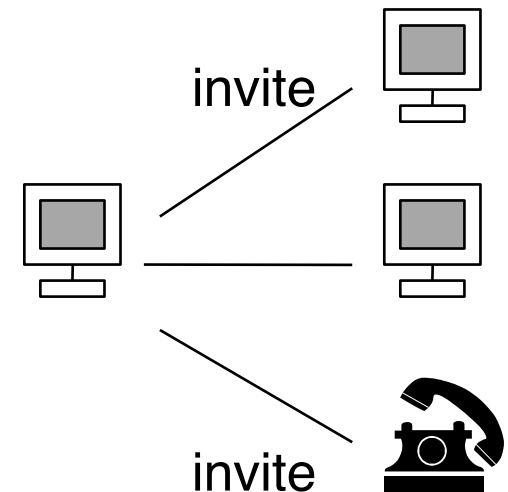

Interactive-Broadcast Conference

- Asymmetric conference
 - Master distributes media and signaling to many terminals
 - Terminals have a much simpler back channel to the master (e.g. just signaling or a plain text stream)
- Scales to thousands of terminals
- Typical applications: tele-teaching, business TV

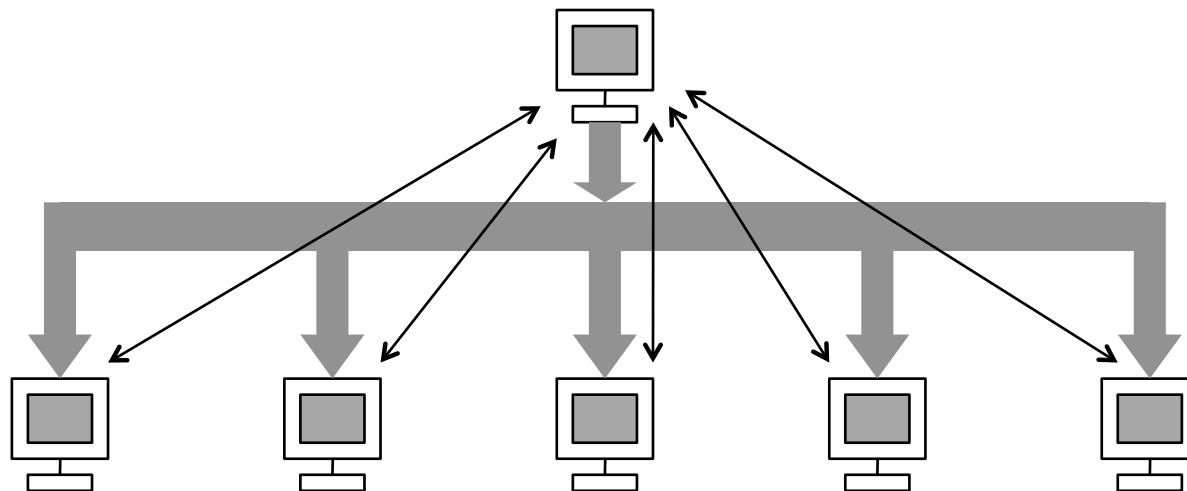

Multi-Unicast Network Configuration

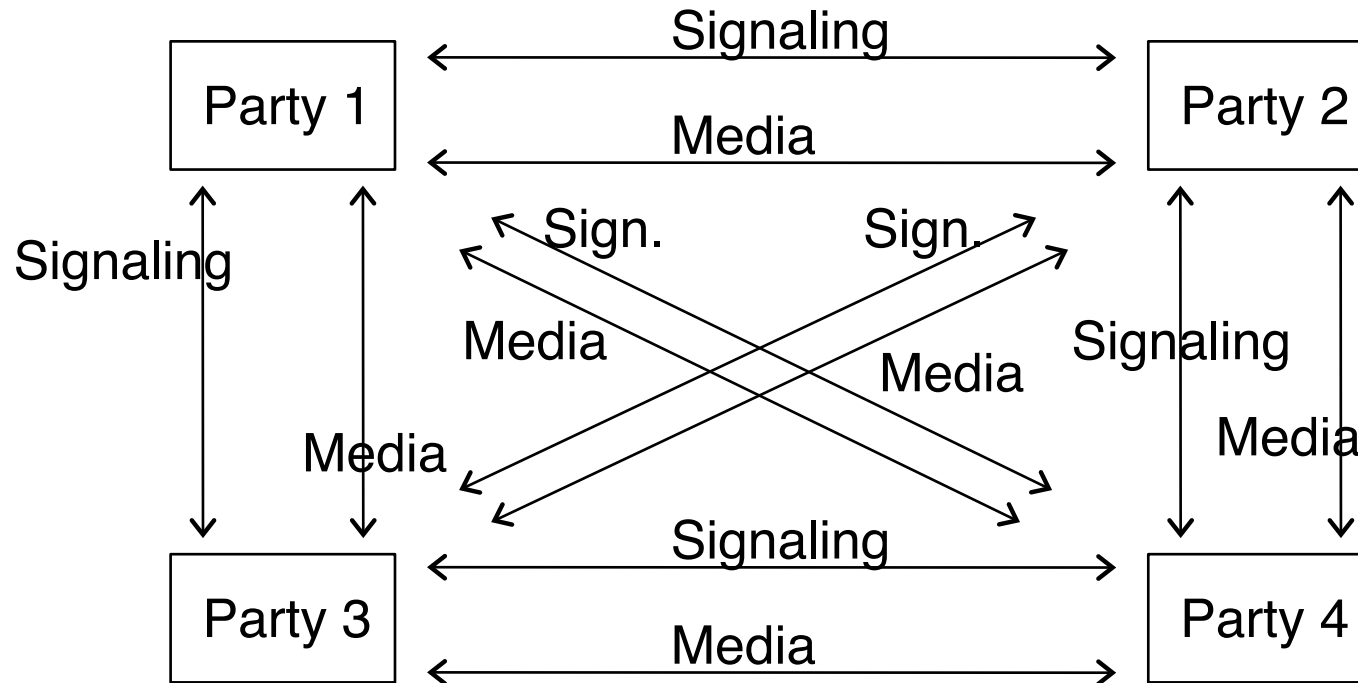

- Difficult to implement, no single point of failure, high bandwidth usage
- Suitable for ad-hoc conferences with low participant numbers

Multicast Network Configuration

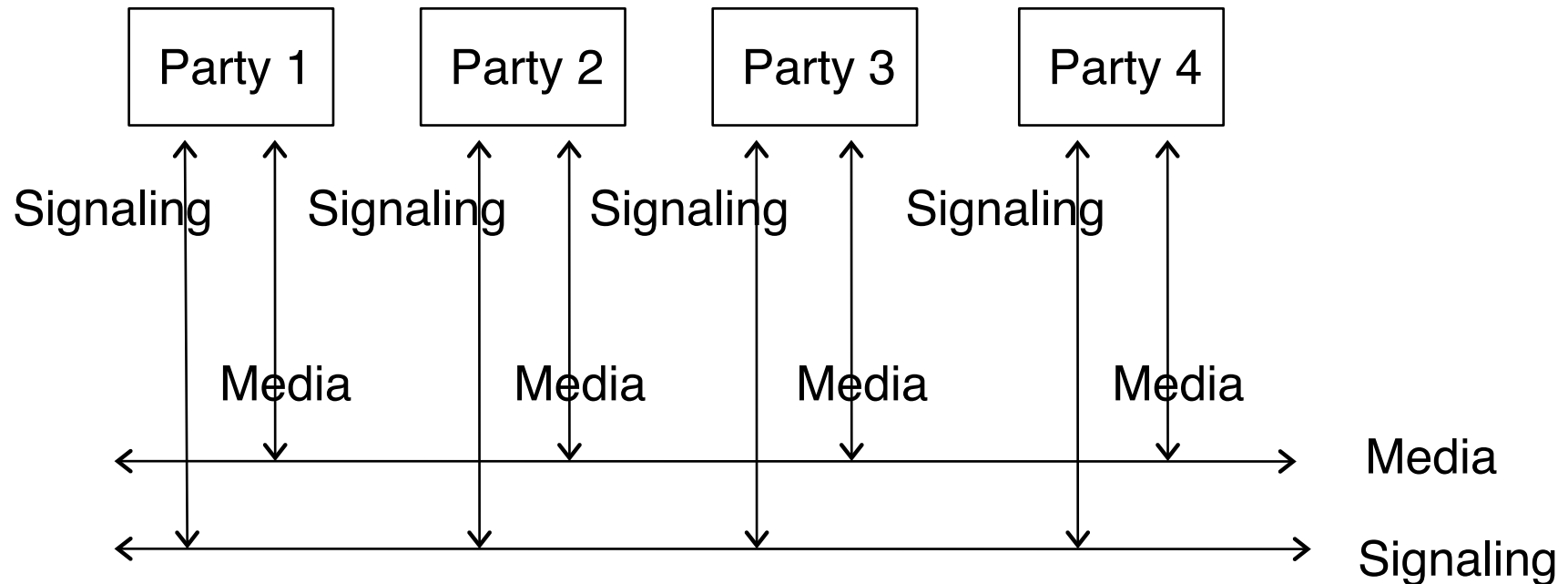

- Uses multicast addresses
- Difficult to implement, no single point of failure, bandwidth-efficient
- Suitable for interactive broadcasts with high number of participants

Master-Slave Network Configuration

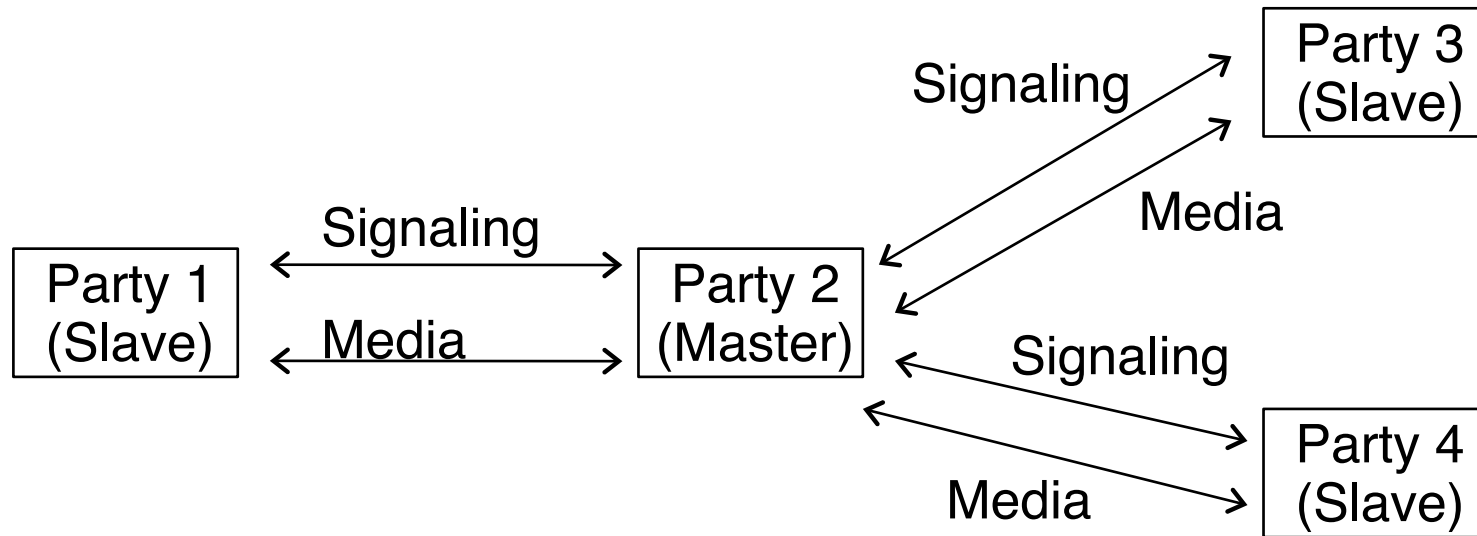

- Easy to implement, single point of failure, medium bandwidth-efficiency
- Suitable for meet-me and ad-hoc conferences of medium size
- *Note:* Hybrid forms may use different configurations for signaling and media!
 - H.323: Master-Slave signaling, master-slave or multicast media distribution

12 Multimedia Conferencing

12.1 Multimedia Conferencing:
Service Definition and Equipment

12.2 Application Examples

12.3 Typology of Multi-Point Conferences

12.4 Standards for Multimedia Conferencing

Literature:

James R. Wilcox: Videoconferencing, the whole picture, 3rd ed,
CMP Media 2000

H.32X Family

- H.323: ITU-T standard “Visual Telephone Terminals over Non-Guaranteed QoS Service LANs”
 - Compatible with ISDN and IP protocols
- Components:
 - Terminals: PCs, workstations, videophones (must support voice-data)
 - Gatekeeper: Access control, address administration
 - Gateway: E.g. interoperability between IP networks and ISDN
 - Multipoint controller: To support multi-point conferences
- H.324: ITU-T standard “Terminal for Low Bit-Rate Multimedia Communication”
 - Point-to-point audio and video over telephone lines
 - Comprises H.263 video compression
- More recent video standards:
 - H.264/MPEG AVC and H.265/MPEG HEVC video compression

Call and Session Signaling in H.32X

- H.225
 - Call signaling and RAS (Registration, Admission, Status) over non-QoS networks
 - Additional protection and recovery mechanisms on top of H.320
- H.245
 - Control protocol for multimedia
 - Information exchange about terminal capabilities (e.g. codecs, ports)
 - Negotiation of logical channels between terminals
 - Can be “tunnelled” through H.225 (firewalls)

Network Architecture for Multimedia Conferences

- Session control:
 - Unit managing participants of a (conference) session
 - Management of involved connections
 - Monitoring of quality
- Signaling:
 - In particular call control:
 - » How does a participant set up/join/tear down a session?
 - Negotiation of capabilities among clients
 - Adaptation to network traffic situation
 - Advanced features (like multiple calls, intelligent forwarding)

Network Architecture Option 1: Skype Based

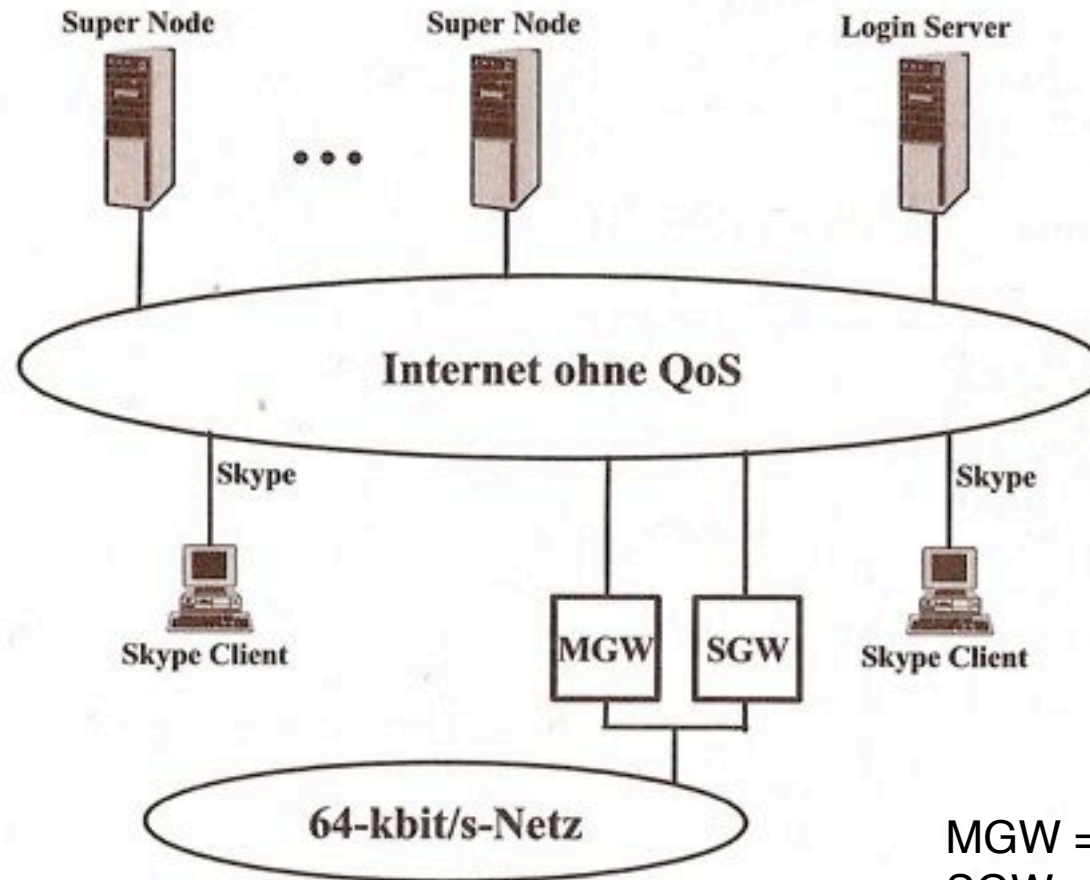

MGW = Media Gateway
SGW = Signaling Gateway

Bild 3.6: Skype für die Session-Steuerung

Trick/Weber

Skype Based Architecture

- Based on KaZaA peer-to-peer file sharing architecture
- Central *Login Server* for authentication
- Many *Super Nodes* form distributed database for user profiles
 - Powerful client computers with fixed address
- Steps in a Skype session:
 - User logs in (Login Server)
 - Client searches for Super Nodes and connects to a Super Node
 - Client gets address of communication partner from Super Node and establishes direct (peer-to-peer) communication link
 - Voice transmission: via UDP, adaptive between 24 and 128 kbit/s
 - » Predictive codecs: iSAC (LPC based), SILK (hybrid predictive/synth.)
 - Encryption of transmitted data
 - » Using AES 256 bit, key exchange through RSA
- Signaling and detailed architecture fully proprietary

Network Architecture Option 2: H.32X Based



Bild 3.4: Protokolle und Netzarchitektur für Next Generation Networks mit H.323 für die Session-Steuerung

Network Architecture Option 3: SIP Based

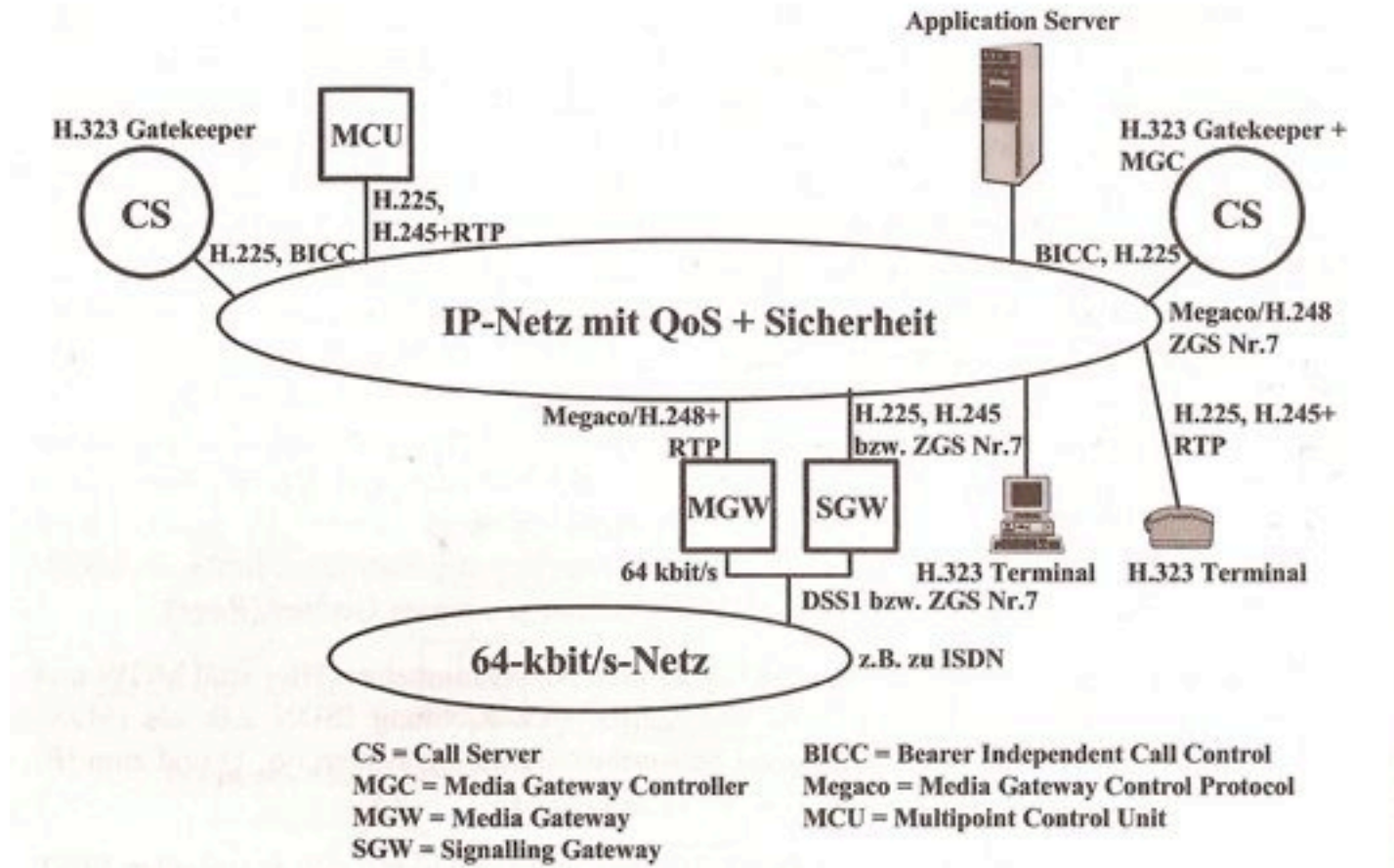

Bild 3.3: Protokolle und Netzarchitektur für Next Generation Networks mit SIP für die Session-Steuerung

Trick/Weber

13 Signaling Protocols for Multimedia Communication

13.1 Signaling and Sessions

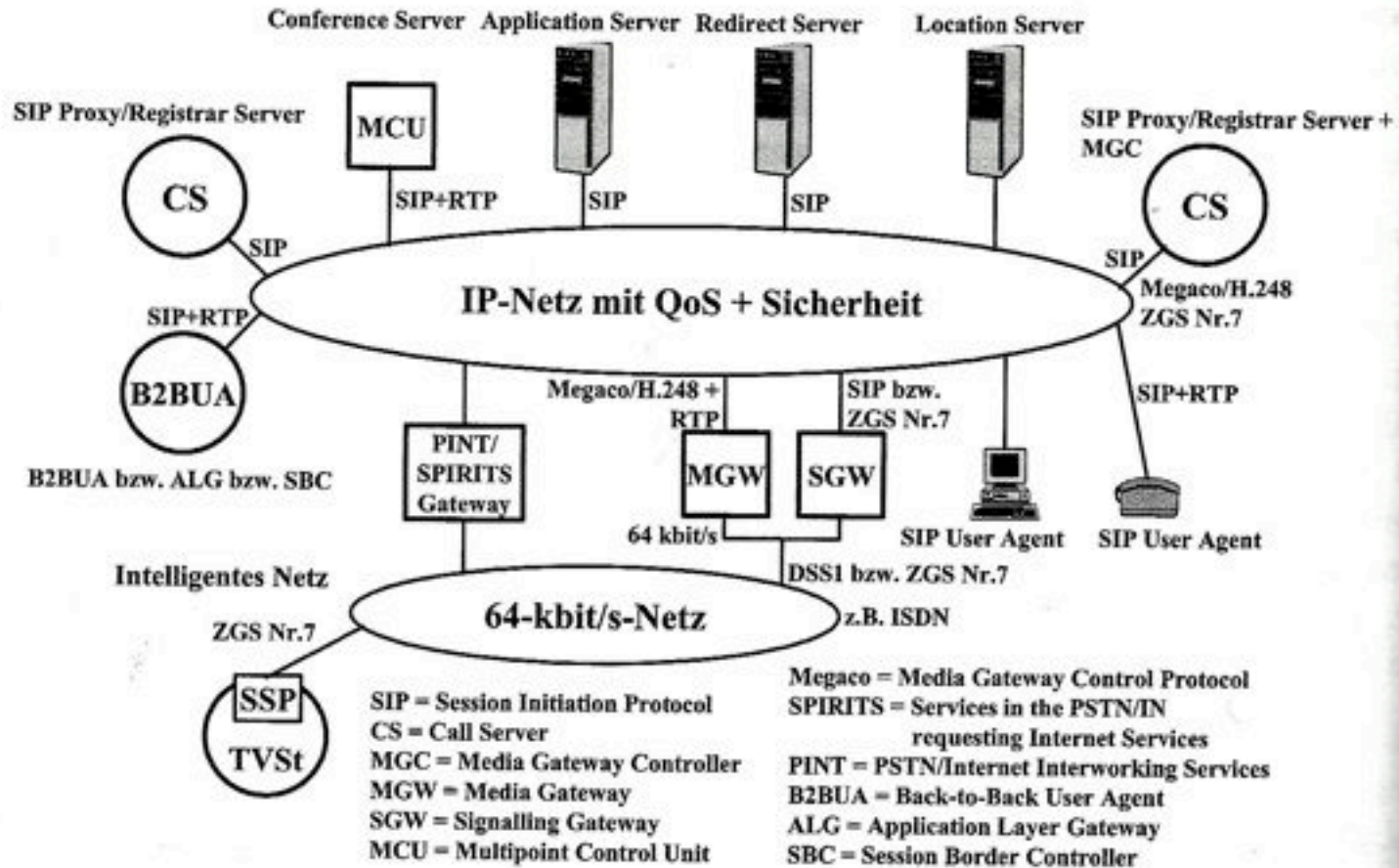
13.2 SIP Basics

13.3 Signaling for Instant Messaging

Literature:

Stephan Rupp, Gerd Siegmund, Wolfgang Lautenschlager:
SIP – Multimediale Dienste im Internet, dpunkt.Verlag 2002

Ulrich Trick, Frank Weber: SIP, TCP/IP und
Telekommunikationsnetze, Oldenbourg, 4. Auflage 2009

SIP - The Context

- SIP = *Session Initiation Protocol*, standardized by IETF (*Internet Engineering Task Force*)
 - Signaling protocol independent of underlying network technology
 - Text-based client/server protocol, similar to HTTP
 - Covers broad range from traditional telephony to multimedia conferencing
 - Peer-to-peer style architecture:
 - » Client contains *User Agent* (UA) in client and server roles (UAC, UAS)
- Developed based on proposals by Mark Handley and Henning Schulzrinne, 1999
- Related other protocols:
 - SDP = *Session Description Protocol*
 - SAP = *Session Announcement Protocol*
 - SCCP = *Simple Conference Control Protocol*
 - RTSP = *Real Time Streaming Protocol*
 - RTP = *Real Time Transport Protocol*
- *MMUSIC = Multiparty Multimedia Session Control*

Main Features & Components of SIP

- SIP Proxy Servers for forwarding of control messages
 - Including “redirect” and “location” servers
- Support of user, terminal and service mobility
- Gateways to traditional networks (e.g. telephone networks)
 - Including services of the so-called “Intelligent Network” (IN), i.e. advanced network features
- Status observation for users and terminals (e.g. online/offline, busy/free)
- Service creation and execution tools
 - Call Processing Language CPL
 - XML-Scripts in SIP server
 - SIP-Java-Servlets
- In the following: Focus (first) on audio connections = “IP telephony”

Addressing in SIP

- SIP supports various address formats including addresses based on phone numbers
 - ITU standard for international phone number format: E.164
- Email style addresses:
`sip:Heinrich.Hussmann@ifi.lmu.de`
- IP-based addresses:
`sip:hussmann@141.84.8.6`
- Phone number style addresses:
`sip:+49-89-2180-4650@net2phone.com`
- Mapping of E.164 telephone numbers to IP domain names
 - +49-89-2180-4650 is mapped to domain name
`0.5.6.4.0.8.1.2.9.8.9.4.E164.arpa`
- IP-based addressing of terminals is a potential problem
 - Many large sites use NAT (network address translation)

SIP Messages

- Text-based peer-to-peer protocol
- Modelled after HTTP
 - *Header* contains connection parameters and service information
 - *Body* contains description of connection (using *Session Description Protocol SDP*)
- Requests:
 - From client (agent) to server (agent)
 - INVITE, BYE, OPTIONS, STATUS, CANCEL, ACK, REGISTER, ...
- Responses:
 - Status information, e.g.
 - » Informational: 100 Trying, 180 Ringing, 181 Call is forwarded, ...
 - » Success: 200 OK
 - » Redirection: 300 Multiple Choices, 301 Moved Permanently, ...
 - » Client Error: 400 Bad Request, 404 Not Found, 486 Busy Here, ...
 - » Server Error: 500 Internal Server Error, 504 Gateway Timeout, ...

Call Setup by Three-Way Handshake

- Direct connection establishment between two SIP terminals (user agents)

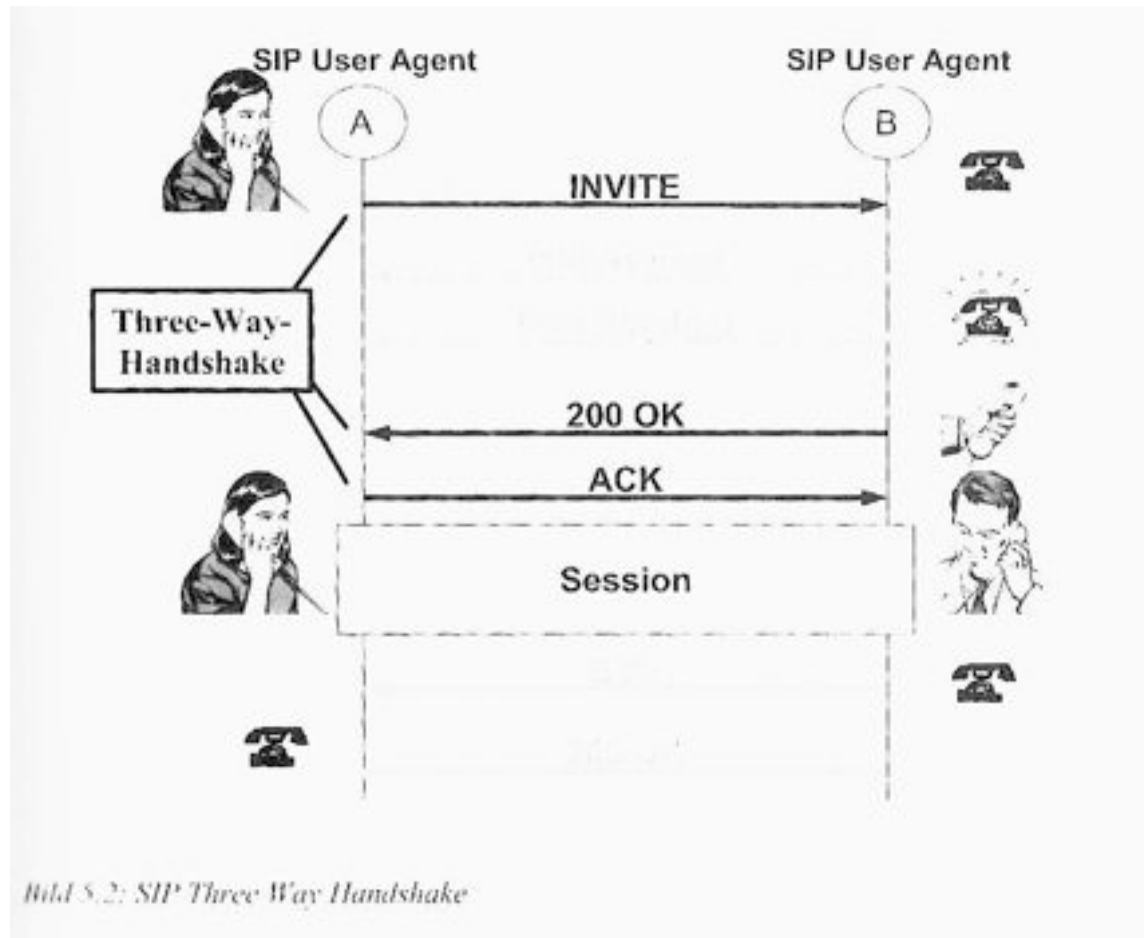

Trick/Weber

Example: SIP Message

INVITE sip:john@domain.com SIP/2.0	<i>Start Line</i>
VIA:SIP/2.0/UDP 169.130.12.5	<i>General Header</i>
Call-ID:187602141351@worchester.bell-telephone.com	
From:<sip:a.g.bell@bell-telephone.com>	
To:T.A.Watson<sip:watson@bell-telephone.com>	
CSeq:1 INVITE	<i>Sequence Number</i>
Subject:Mr. Watson, come here	<i>Request Header</i>
Content-Type:application/sdp	<i>Entity Header</i>
Content-Length:885	
v=0	<i>Body: SDP Data</i>
o=bell 536557652353687637 IN IP4 128.3.4.5	
c=IN IP4 135.180.144.94	
m=audio 3456 RTP/AVP 0 3 4 5	

SDP Information

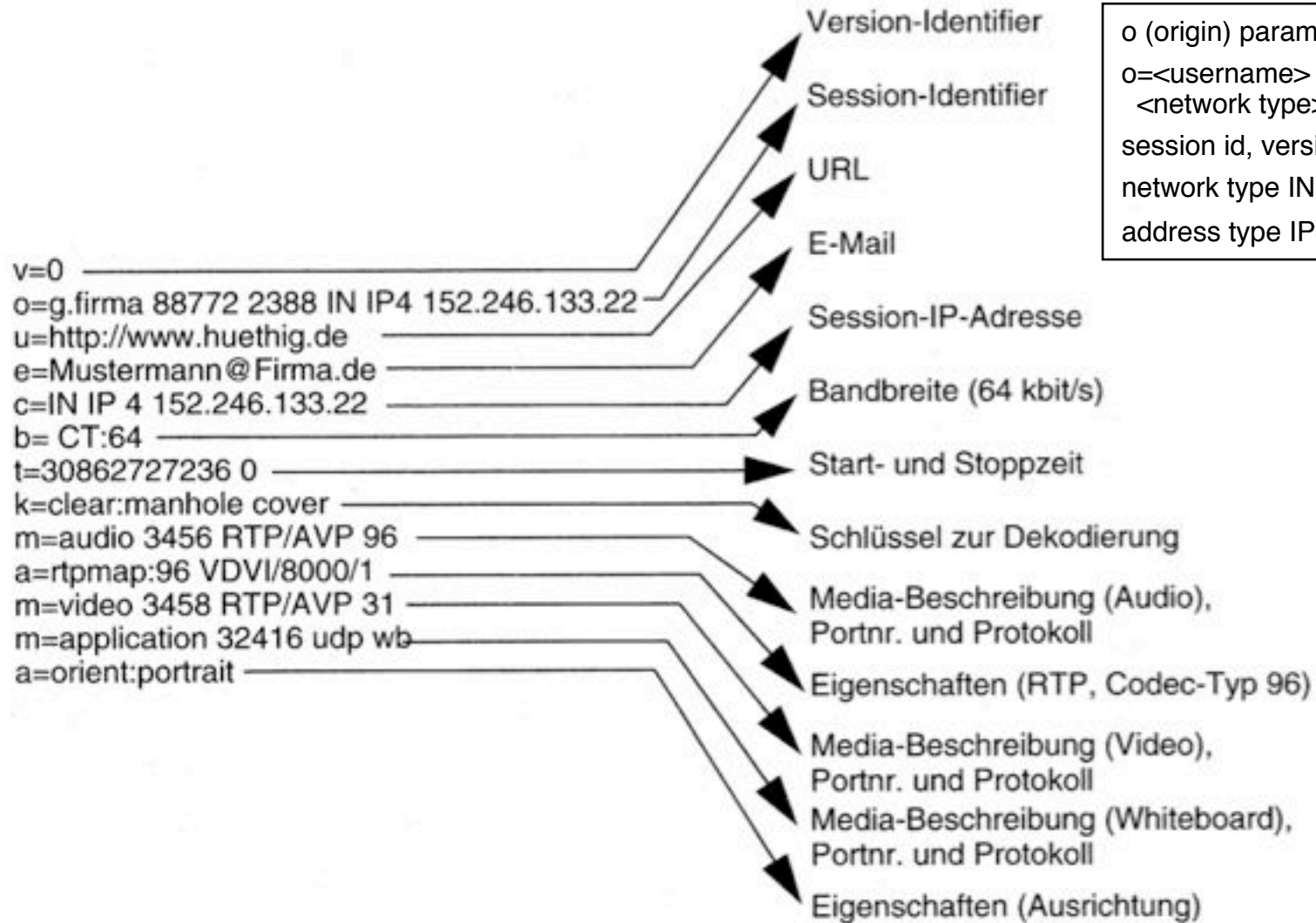

o (origin) parameter:
 o=<username> <session id> <version>
 <network type> <address type> <address>
 session id, version: NTP timestamp
 network type IN = Internet
 address type IP4 or IP6

SDP Media Description and Attributes

- Media description (*m*)
 - Media type (e.g. *audio*)
 - Used port number
 - User data transport protocol
 - » e.g. RTP/AVP = Real-Time Transport Protocol, Audio/Video Profile
 - List of available formats/codecs
 - » "96" in previous example, may be a list of options
- Attribute description (*a*)
 - Codec details for all mentioned media formats
 - E.g. from "rtpmap" in RTP/AVP standard (IETF RFC 3551)

Example for Multiple Media Formats

```
m=audio 2410 RTP/AVP 0 8 3 4  
a=rtpmap:0 PCMU/8000  
a=rtpmap:8 PCMA/8000  
a=rtpmap:3 GSM/8000  
a=rtpmap:4 G723/8000
```

- Communication partner announces the codecs/formats which are locally supported
- Standardized list of RTP-Codex in RTP/AVP standard, excerpt:

Payload type	Encoding name	Media type	Clock rate	Channels
0	PCMU (μ -law)	A	8000	1
1	reserved	A		
2	reserved	A		
3	GSM	A	8000	1
4	G723	A	8000	1
5	DVI4	A	8000	1
6	DVI4	A	16000	1
7	LPC	A	8000	1
8	PCMA (a-law)	A	8000	1

Codec Negotiation by Offer&Answer

- In connection establishment dialogue (3-way handshake):
 - Partner A sends *offer* (list of supported codecs) as SDP part of *INVITE*
 - Partner B selects appropriate options and specifies them as SDP part of *OK*
- Example:
 - Offer:
`m=audio 2410 RTP/AVP 0 8 3 4`
 - Answer:
`m=audio 2468 RTP/AVP 0 3`
- Analogous negotiation for multiple media channels
 - E.g. audio + video
 - E.g. chat, possibly encrypted
 - E.g. file transfer

Example: Parallel Call Forking (e.g. Call Center)

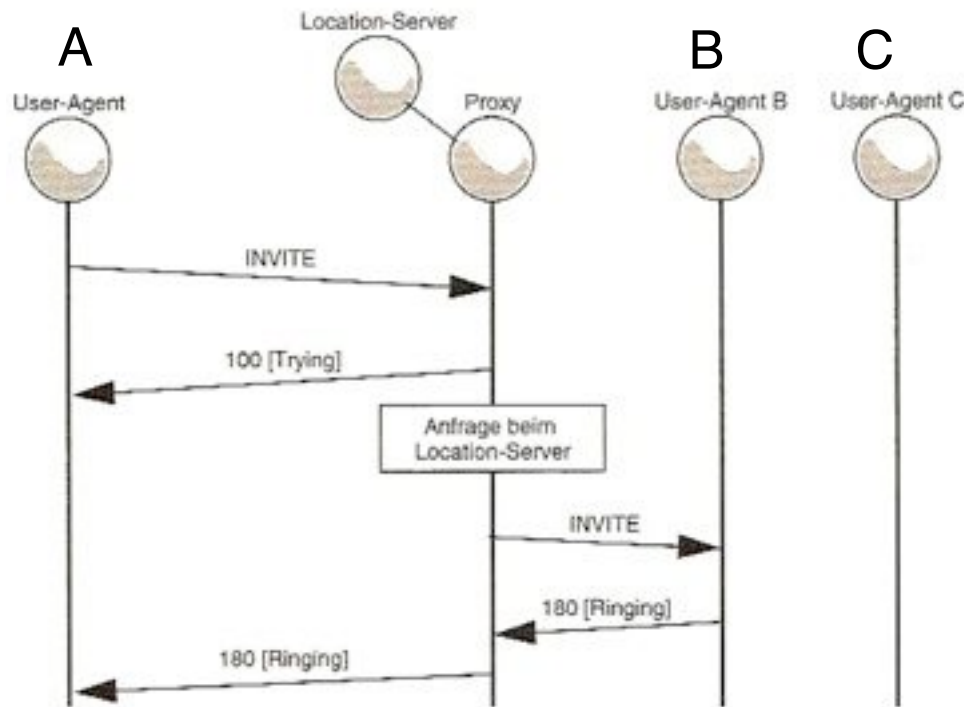

Continued in right column

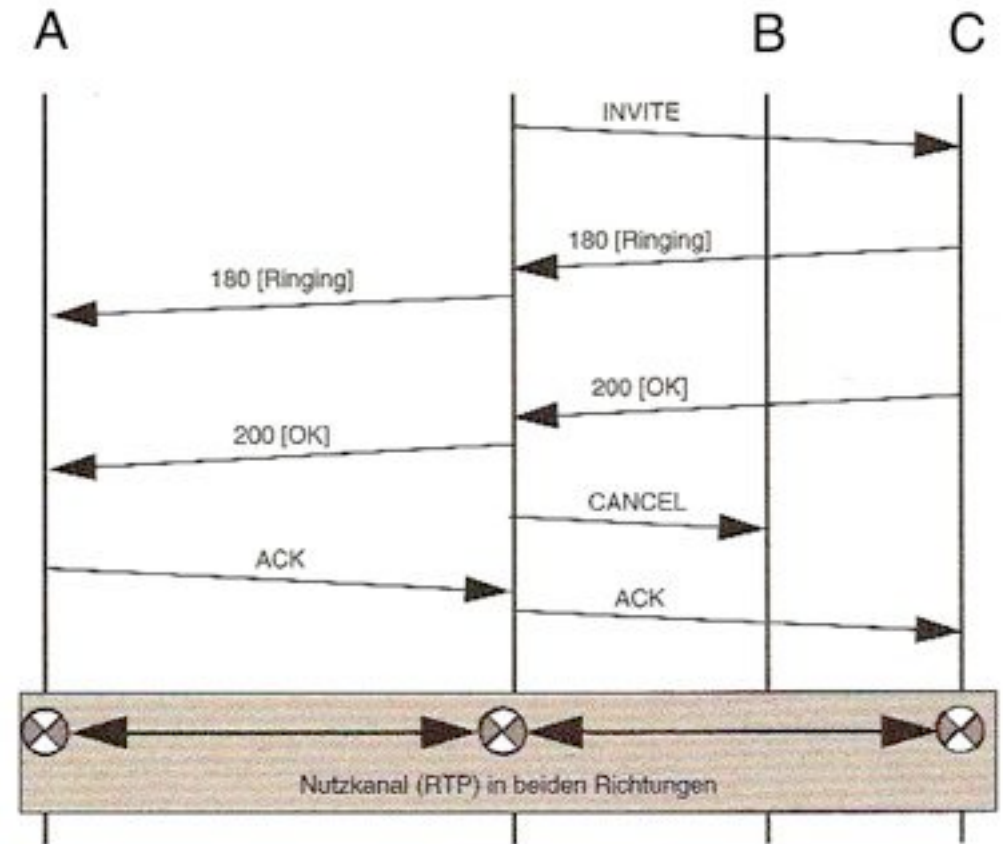

13 Signaling Protocols for Multimedia Communication

13.1 Signaling and Sessions

13.2 SIP Basics

13.3 Signaling for Instant Messaging

Literature:

www.ietf.org/impp

www.xmpp.org

Instant Messaging (IM)

- Exchange of text information between clients in real-time
- Usually combined with *presence information*
- Traditionally computer-based, but may be used on other devices
- Modern clients often integrated with audio/video conferencing
- History:
 - 1970s: Terminal-based messaging (e.g. Unix “talk”)
 - Commercial GUI-based systems: ICQ (1996), AOL Instant Messenger (1997)
 - Many incompatible systems: Yahoo, MSN, Excite, ...
 - 2000: Open-source protocol “Jabber”, developed into XMPP
 - Current: Multi-protocol clients, e.g. Adium, Digsby, Pidgin, Trillian, iChat, ...
- Architecture:
 - Many clients, few servers
 - Device-based or network-based (server-based)
 - Centralized servers (e.g. ICQ) vs. decentralized servers (e.g. Jabber)

Signaling for Instant Messaging

- Proprietary protocols for specific services!
- Several efforts for standardization, two important examples:
- SIMPLE (SIP for Instant Messaging and Presence Leveraging Extensions)
 - RFCs 3428, 3856, 3863, 4479, ... and many drafts
 - Messaging as extensions of the SIP protocol
 - Currently no multimedia support, just text messages
- XMPP (Extensible Messaging and Presence Protocol)
 - Standardized form of XML-based streaming and presence protocols developed by the “Jabber” community (since 1999)
 - IETF standardization 2002–2004: RFCs 3920-23
 - Quite complete, covers e.g. authentication and encryption, multi-user chat, privacy blocking
 - Increasing support from commercial IM applications
 - » e.g. Google Talk, Apple iChat, Facebook Chat XMPP Interface (2010)

SIMPLE Example (1): Message

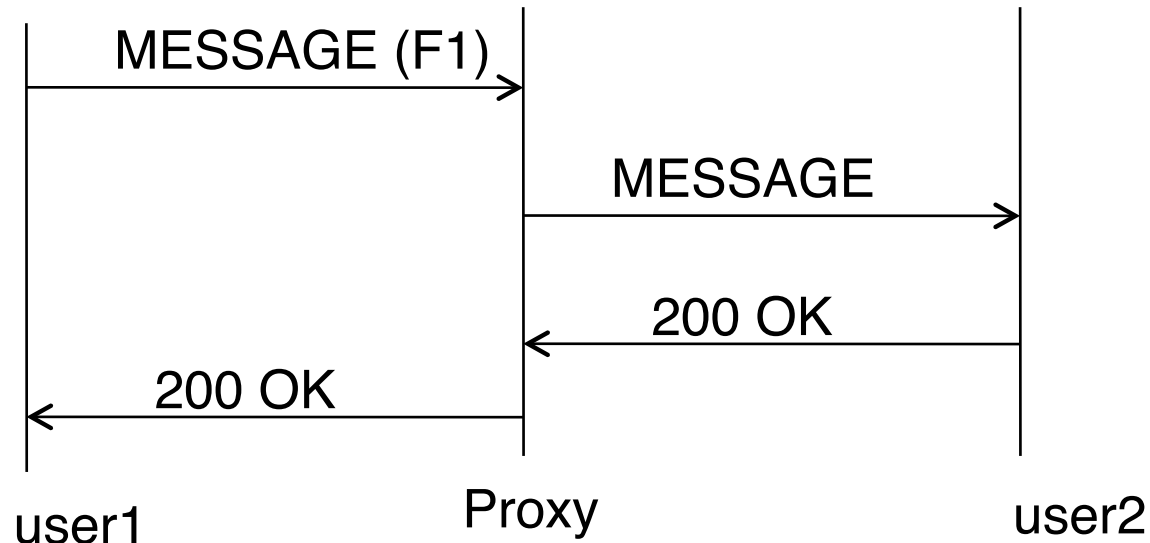

F1: MESSAGE sip:user2@domain.com SIP/2.0
Via: SIP/2.0/TCP user1pc.domain.com;branch=z9hG4bK776sgdkse
Max-Forwards: 70
From: sip:user1@domain.com;tag=49583
To: sip:user2@domain.com
Call-ID: asd88asd77a@1.2.3.4
CSeq: 1 MESSAGE
Content-Type: text/plain
Content-Length: 18
Watson, come here.

SIMPLE Example (2): Presence

```

SUBSCRIBE sip:resource@example.com SIP/2.0
Via: SIP/2.0/TCP watcherhost.example.com;...
To: <sip:resource@example.com>
From: <sip:user@example.com>;tag=xfg9
...
Event: presence
Accept: application/pidf+xml
Contact: <sip:user@watcherhost.example.com>
Expires: 600 ...
    
```

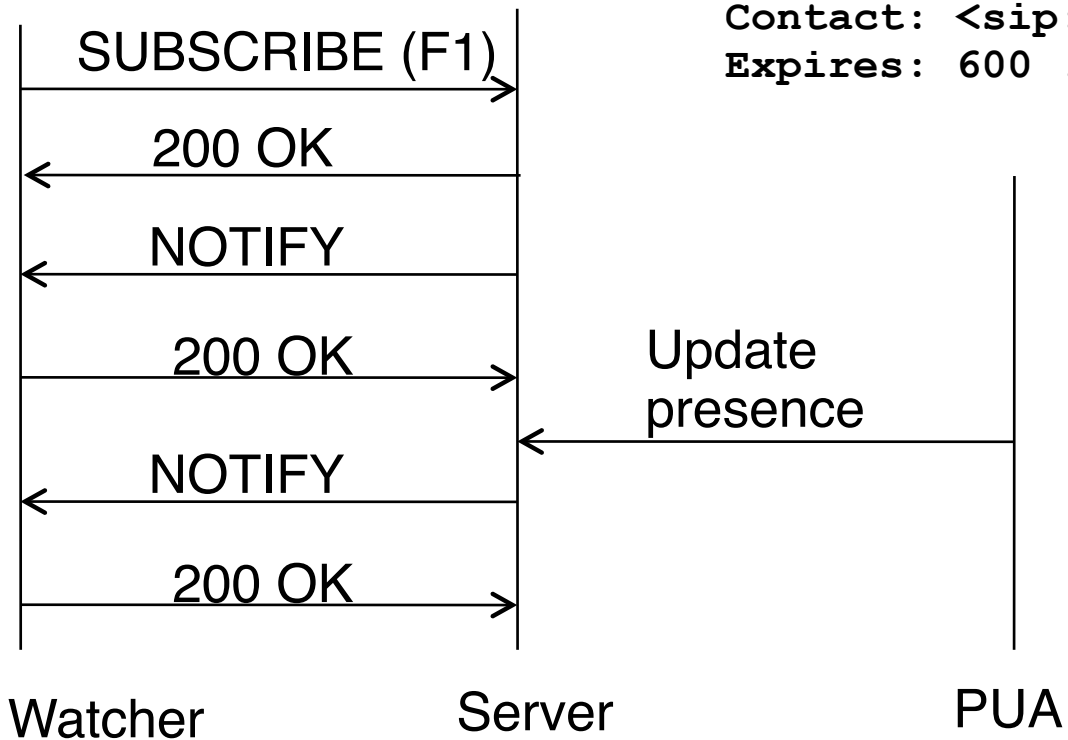

PIDF (RFC 3863):
Presence Indication
Data Format

XMPP

- Based on generic transport protocol for XML streams over the Internet
- Idea:
 - Two-way exchange of XML files of potentially infinite length
 - Transmission of discrete semantic units (*XML stanzas*)

```
<stream>
  <presence>
    <show/>
  </presence>
  <message to='foo'>
    <body/>
  </message>
  <iq to='bar'>
    <query/>
  </iq>
  ...
</stream>
```

iq = info/query



XMPP Example

C \longleftrightarrow S

```
C: <?xml version='1.0'?>
  <stream:stream
    to='example.com'
    xmlns='jabber:client'
    xmlns:stream='http://etherx.jabber.org/streams'
    version='1.0'>
S: <?xml version='1.0'?>
  <stream:stream
    from='example.com'
    id='someid'
    xmlns='jabber:client'
    xmlns:stream='http://etherx.jabber.org/streams'
    version='1.0'>
... encryption, authentication, and resource binding ...
C: <message from='juliet@example.com'
  to='romeo@example.net'
  xml:lang='en'>
C:   <body>Art thou not Romeo, and a Montague?</body>
C: </message>
S: <message from='romeo@example.net'
  to='juliet@example.com'
  xml:lang='en'>
S:   <body>Neither, fair saint, if either thee dislike.</body>
S: </message>
C: </stream:stream>
S: </stream:stream>
```

Source: RFC 3920

14 Visions and Outlook

14.1 Innovation and Prognoses

14.2 Trends and Visions

Prognosen (1)

"Das Auto ist fertig entwickelt. Was kann noch kommen?"

Karl Benz um 1920

Quelle: Frankfurter Allgemeine Sonntagszeitung, 19.5.2002

"Das Telefon hat zu viele ernsthaft zu bedenkende Mängel für ein Kommunikationsmittel. Das Gerät ist von Natur aus von keinem Wert für uns."

Western Union, Interne Kurzinformation, 1876

"Das Radio hat keine Zukunft"

Lord Kelvin, Mathematiker und Physiker, 1897

Quelle: Newsweek 27.01.1997

"Die drahtlose Musikbox hat keinen denkbaren kommerziellen Wert. Wer würde für eine Nachricht bezahlen, die zu niemanden direkt gesendet wird?"

David Sarnoff in einer Rückmeldung zur Investition in das Radio um 1925

"Das Fernsehen wird nach den ersten sechs Monaten am Markt scheitern. Die Menschen werden es bald satt haben, jeden Abend in eine Sperrholzkiste zu starren."

Darryl F. Zanuck, Chef der 20th Century-Fox, 1946

maxeiner-miersch.de

Prognosen (2)

"Ich glaube, es gibt einen weltweiten Bedarf an vielleicht fünf Computern."
IBM-Chef Thomas Watson im Zweiten Weltkrieg
Quelle: Ute Dorau und Peter Woeckel, "Jobreport Informationstechnologie", München 2001

"Es gibt keinen Grund, warum irgendjemand einen Computer in seinem Haus wollen würde."
Ken Olson, Präsident, Vorsitzender und Gründer von Digital Equipment Corp., 1977
Quelle: NZ-Herald, 15.12.2008

"Also gingen wir zu Atari. Und sie sagten, ‚Nein‘. Dann gingen wir zu Hewlett-Packard, und sie sagten, ‚Hey, wir brauchen Sie nicht, Sie haben das College noch nicht abgeschlossen‘."
Apple Computer Inc. Gründer Steve Jobs über seine Versuche, Atari und H-P an seinem Personal Computer zu interessieren

"In zwei Jahren wird das Spam-Problem erledigt sein."
Bill Gates, 2004
Quelle: NZ-Herald, 15.12.2008

"Das Internet wird kein Massenmedium, weil es in seiner Seele keines ist."
DIE WELT, 24.03.2001

Revolutions and Evolution

- Technological revolutions:
 - Roots in different areas of science (e.g. Laser, Public/Private-Key)
- Transfer revolutions:
 - Known techniques applied in new domain (e.g. Bezier curves)
- Recombination revolutions:
 - New combination of known techniques (e.g. Smartphones)
- *Appropriation* of new technologies does not follow revolutionary scheme but proceeds in evolutionary way:
 - Slow social processes
 - Adaptation of behavioral patterns
 - Learning processes
 - Reputation building

14 Visions and Outlook

14.1 Innovation and Prognoses

14.2 Trends and Visions

Roots of YouTube

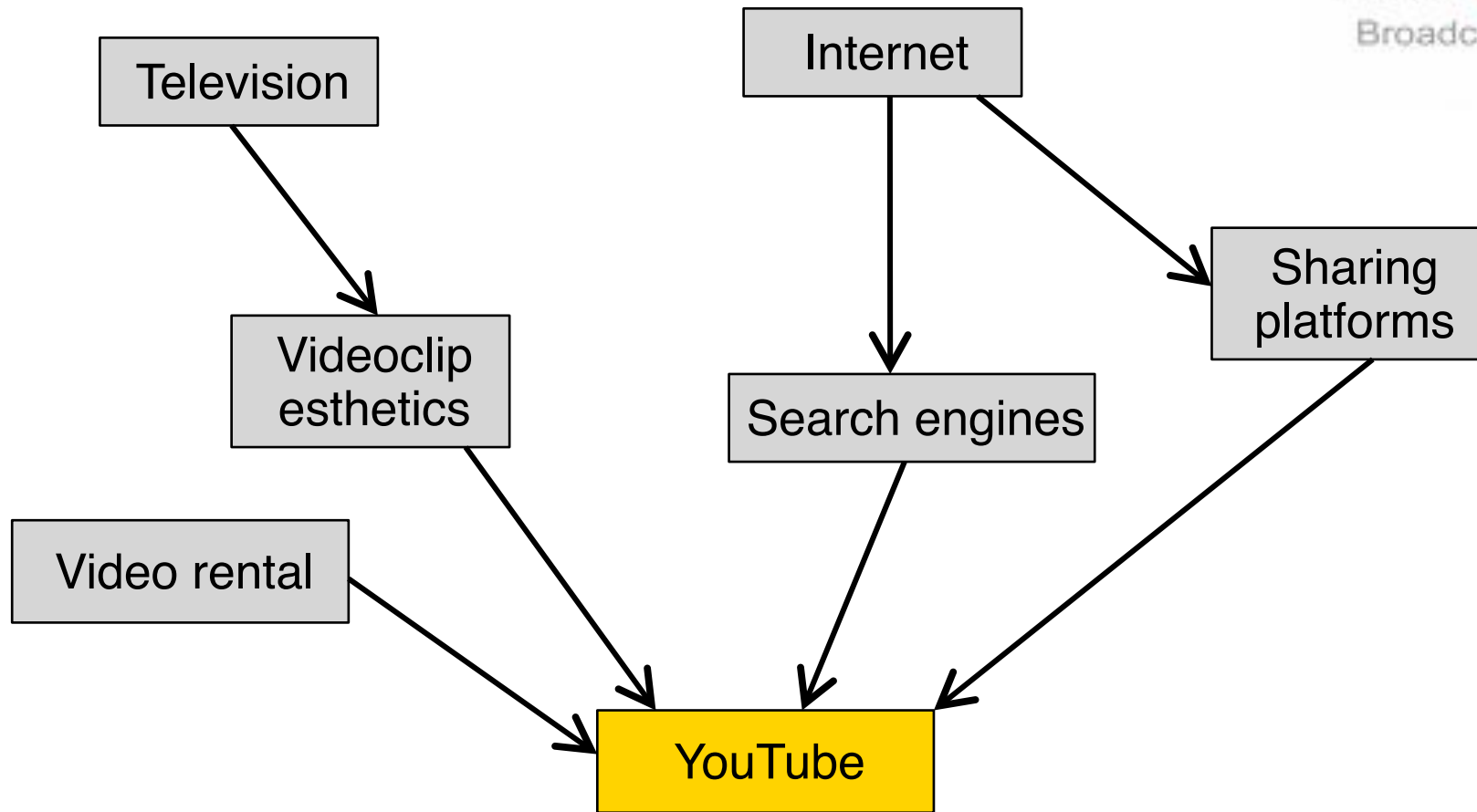

Roots of Apple iPad

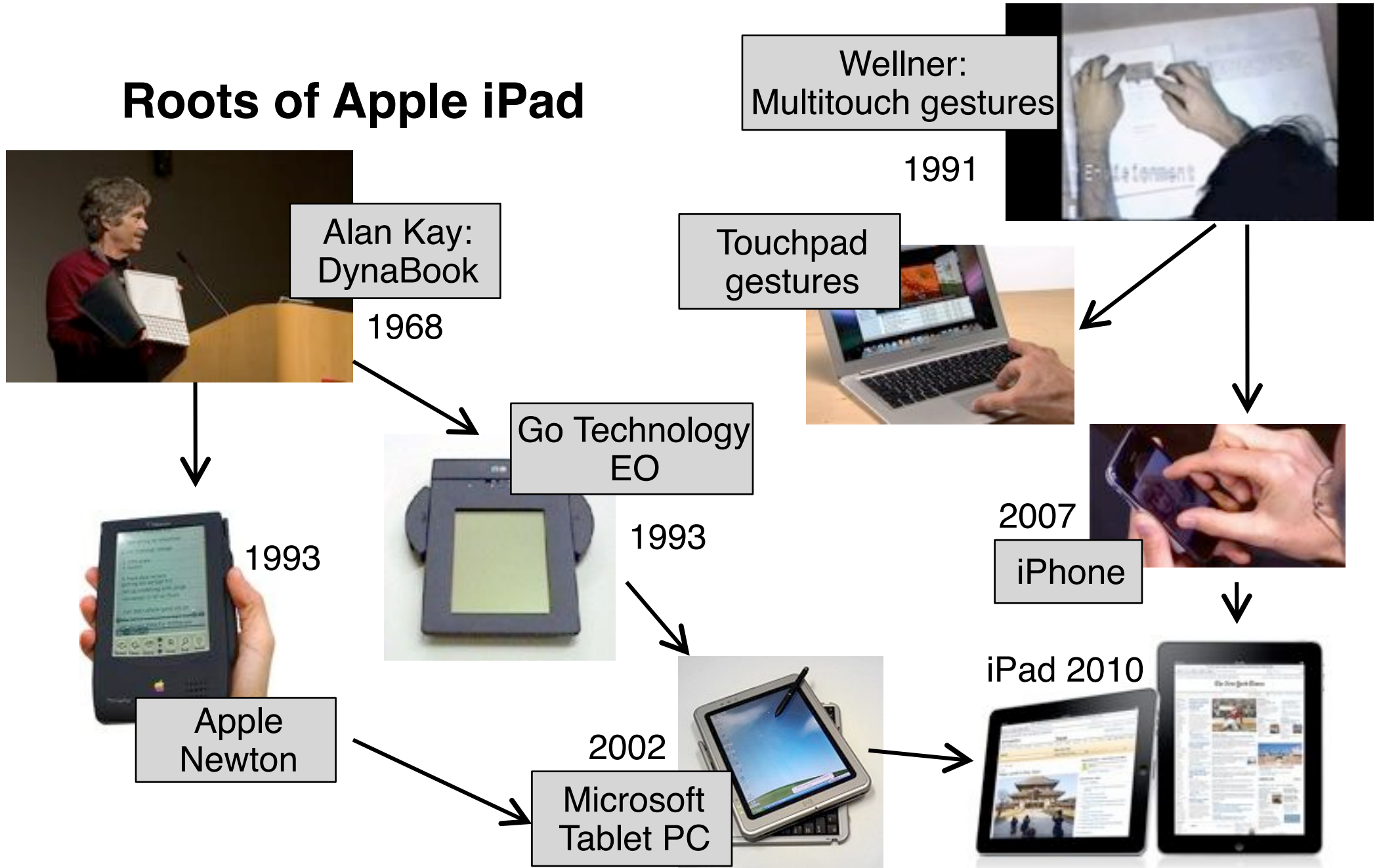

Obvious Trends

- Multimedia is not dead at all
 - Modern devices (see iPad) target multimedia mainly
 - » Example multimedia newspaper
 - Multimedia Revolution is still going on
- Networks are being expanded all the time
 - Higher bandwidth
 - Better interoperability
 - Convergence of technologies
- So "Networked Multimedia" is the future, simply?