

5 Theorien und Untersuchungen zum multimedialen Lernen

5.1 Multimediales Lernen: Erwartungen und Realität



5.2 Modelle der kognitiven Verarbeitung von Multimedia

5.3 Cognitive Theory of Multimedia Learning

5.4 Methodische Fragen zu Lerntheorien

5.5 Alternative Theorien des Multimedia-Lernens

Literatur:

Kentaro Toyama: There Are No Technology Shortcuts to Good Education,
Educational Technology Debate, Jan. 2011

<https://edutechdebate.org/ict-in-schools/there-are-no-technology-shortcuts-to-good-education/>

Richard E. Mayer (ed.): The Cambridge Handbook of Multimedia Learning,
Cambridge University Press 2005

100 Years of Technology in Education

- **Edison 1922:**

“The motion picture is destined to revolutionize our educational system, and in a few years it will supplant largely, if not entirely, the use of textbooks”

- **William Levenson 1945:**

“A radio receiver will be as common in the classroom as the blackboard”, “Radio instruction will be integrated into our school life”

Larry Cuban: Teachers and Machines: The Classroom Use of Technology since 1920.
Teachers College Press 1986



- **Wilbur Schramm 1964:**

“What if the full power and vividness of television teaching were to be used to help the schools develop a country’s new educational pattern?”

Experiment in American Samoa, mid-1960s: “education” of 80% of students based on educational TV.

Computer Technology in Education

Patrick Suppes: The Uses of Computers in Education. Scientific American, 215(3):207-220, 1966

[Computers can] “adapt mechanical teaching routines to the needs and the past performance of the individual student.”

Mark Warschauer: Laptops and Literacy: Learning in the Wireless Classroom. Teachers College Press 2006

“placing computers and Internet connections in low-[income] schools, in and of itself, does little to address the serious educational challenges faced by these schools. ... can in fact be counterproductive.”



Study on a Peruvian One Laptop Per Child (OLPC) project:
After three months, no significant gains in academic achievement.
Usage decreases after initial interest.

<http://www.iadb.org/document.cfm?id=35370099>

„Multimedia“-Begriff

- "... the multimedia part of the definition reflects the idea that the multimedia instructional message is presented using both words and pictures."

Mayer 2001, p. 22

- *Multicodalität* als Mindestvoraussetzung
 - Verschiedene Symbolsysteme (Text, Bild)
 - Gleicher Eingabekanal (Visuell)
- *Multimodalität* als zweite Stufe
 - Verschiedene Symbolsysteme (Text, Bild, Musik)
 - Verschiedene Eingabekanäle (Visuell und auditiv)
 - Unterscheidung:
 - » Text als Ton (Alternative zu monomodaler Präsentation)
 - » Nicht-textuelle Ton-Information
(Präsentationsform jenseits monomodaler Präsentationen)

Claimed Benefits of Multimedia

- From <http://http-server.carleton.ca/~shick/mypage/benifit.html>:

- **Improves Learning**

Numerous studies over the years have shown that interactive multimedia learning takes less time, is enjoyed more and increases learning. In a review of numerous meta-analysis studies Najjar (1996:30) found that "learning was higher when information was presented via computer-based multimedia systems than traditional classroom lectures".

- **Interactive**

Interactivity is mutual action between the learner, the learning system, and the learning material. Numerous studies have found that interactivity has a strong positive effect on learning (Bosco, 1986, Fletcher, 1989, 1990, Stanfford, 1990). For example, Bosco (1986) reviewed 75 learning studies and found that learners learn faster, and have better attitudes toward learning when using interactive multimedia.

Properties of Multimedia Which May Enhance Learning

(Partially based on <http://http-server.carleton.ca/~shick/mypage/benifit.html>:)

- **Immersive:** Uses a large part of the human cognitive system
- **Flexible & modular:** Adaptable to the individual situation
- **Demanding & consistent:**
Forces teachers to work out the material in good structure
- **Realistic:**
Can represent real-life situations, to support problem-based learning
- **Timely:** Can be used at the time when needed
- **Engaging:** Keeps learners interested and reinforces skills
- **Cost-effective**

5 Theorien und Untersuchungen zum multimedialen Lernen

5.1 Multimediales Lernen: Erwartungen und Realität

5.2 Modelle der kognitiven Verarbeitung von Multimedia



5.3 Cognitive Theory of Multimedia Learning

5.4 Methodische Fragen zu Lerntheorien

5.5 Alternative Theorien des Multimedia-Lernens

Literatur:

Günter Daniel Rey: E-Learning, Huber 2009 (Kap. 2)

Richard E. Mayer (ed.): The Cambridge Handbook of Multimedia Learning, Cambridge University Press 2005

Assumptions for a Cognitive Theory of Multimedia

- Dual channels assumption
 - Separate information processing channels
 - » Visual/pictorial channel
 - » Auditory/verbal channel
 - Sensory *modalities* (eyes/ears): two input channels
 - *Coding* as picture/word: two storage forms
 - Cross-channel representations are possible (e.g. reading, narration)
- Limited capacity assumption
 - Limits for the amount of information that can be processed in each channel at one time
 - Short-term memory: approx. seven chunks
 - Allocation of resources by central memory control processes
- Active processing assumption
 - Learners are active processors, not passive recorders

Cognitive Load Theory

- Sweller et al. 1998
- Cognitive Load (Kognitive Belastung)
 - Intrinsic cognitive load
 - » Teaching materials and interrelationships between elements
 - » High intrinsic load requires many elements to be processed simultaneously
 - » Presentation (multimedia) only relevant when intrinsic c.l. is high
 - Extrinsic cognitive load
 - » Dependent on way of presentation
 - » Shall be reduced by design of presentation
 - Germane cognitive load
 - » Dependent on learning task
 - » Spent for construction of schemata in long-term memory
 - » Shall be maximized

Principle of Cognitive Load-Based Theories

- Define a model of human cognition
 - Including tests for measuring values
- Carry out empirical studies
 - Comparing different designs of learning materials
- Give recommendations
 - For design of learning materials
- Several theories of this type:
 - Sweller’s cognitive load theory
 - **Richard Mayer’s Cognitive Theory of Multimedia Learning (CTML)**
 - » By far the most prominent and most widely known theory
 - Refinements and variants of CTML
- Alternative approaches exist!
- Following material based on **CTML**



Richard E. Mayer

Cognitive Model of Multimedia Learning

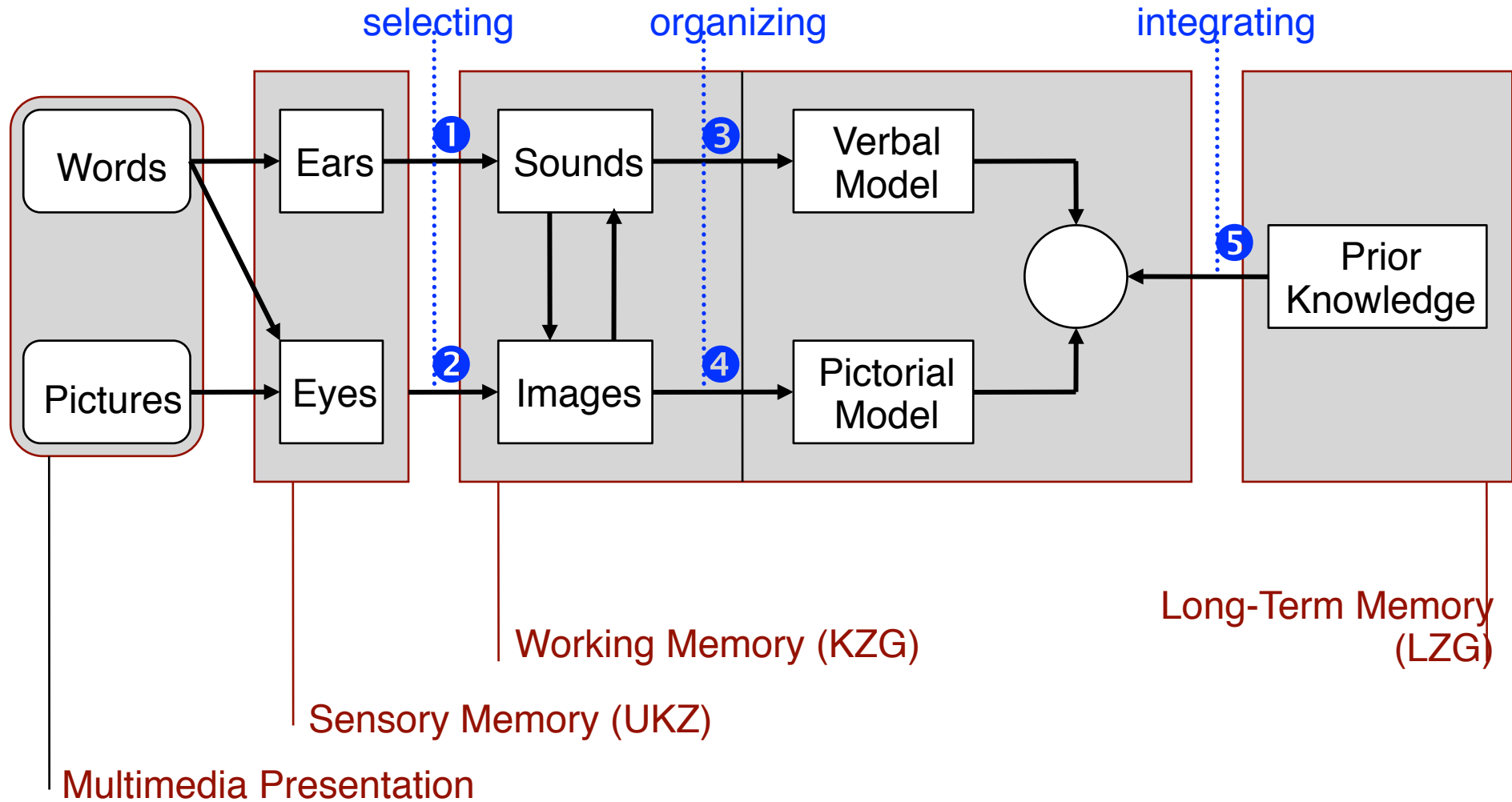

Five Steps of Understanding

Basic processes, not necessarily in this order (arbitrary moves)

1. Selecting relevant words

- Paying attention to *some of* the presented words

2. Selecting relevant images

- Paying attention to *part of* the illustrations and animations presented

3. Organizing selected words

- Building connections amongst words, e.g. cause-effect chains

4. Organizing selected images

- Building structures that make sense to the learner, e.g. cause-effect-chains

5. Integrating word-based and image-based representations

- Making connections between word-bases and image-based representations
- Most relevant for *multimedia*
- Extremely demanding process: "sense making"
- Carried out only segment by segment for larger presentations

Example: Processing of Pictures

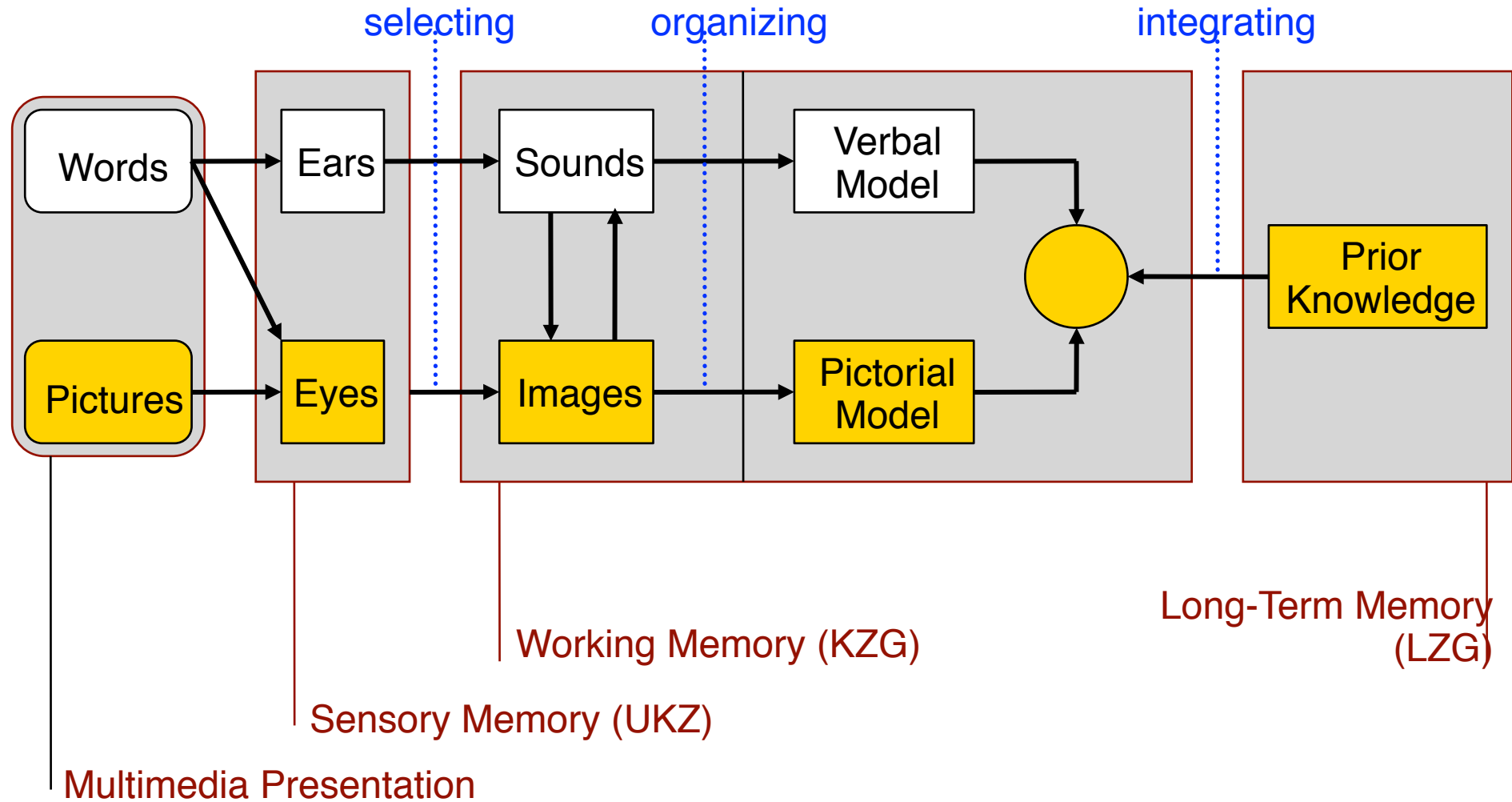

Example: Processing of Spoken Words

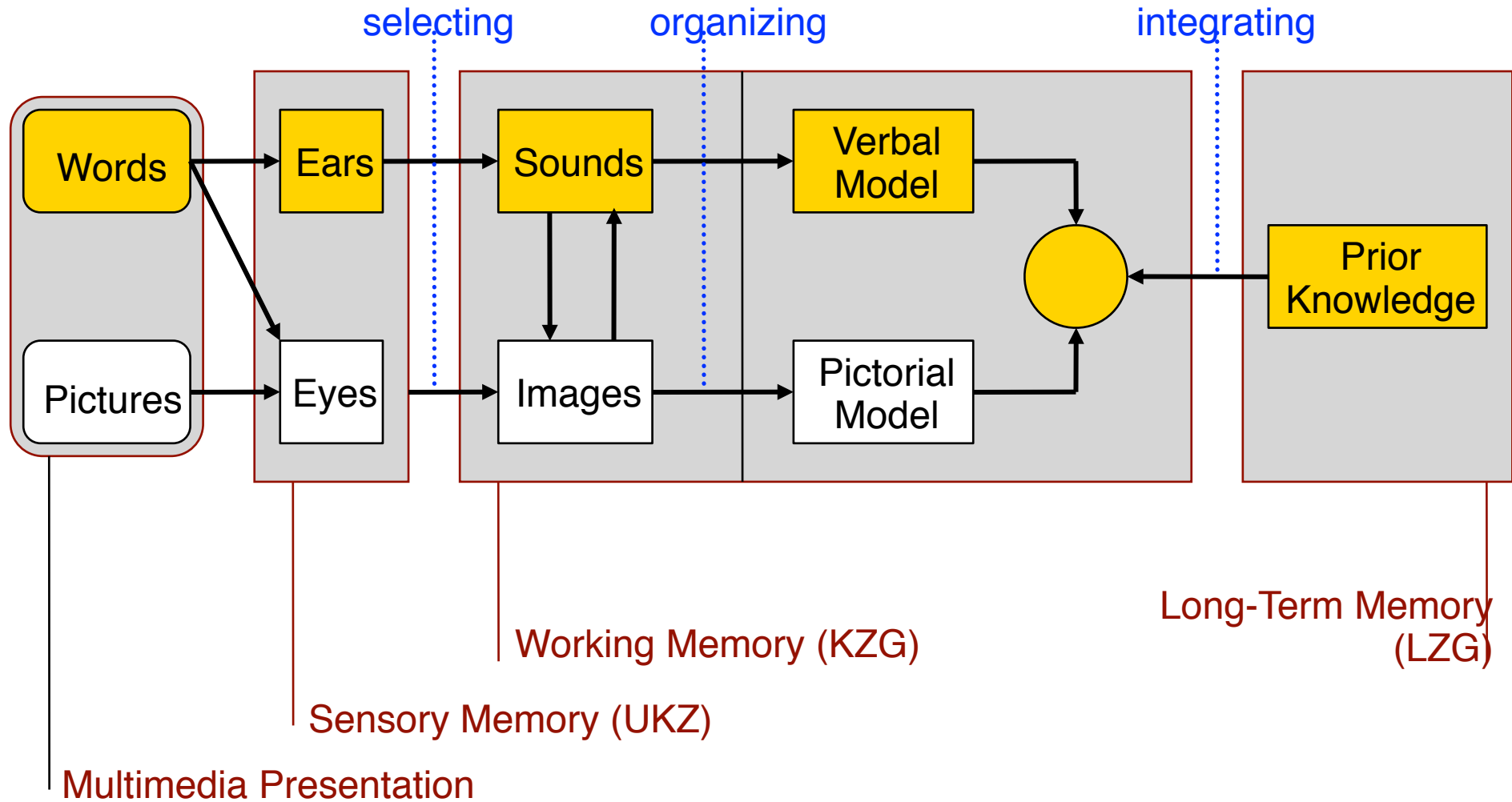

Example: Processing of Printed Words

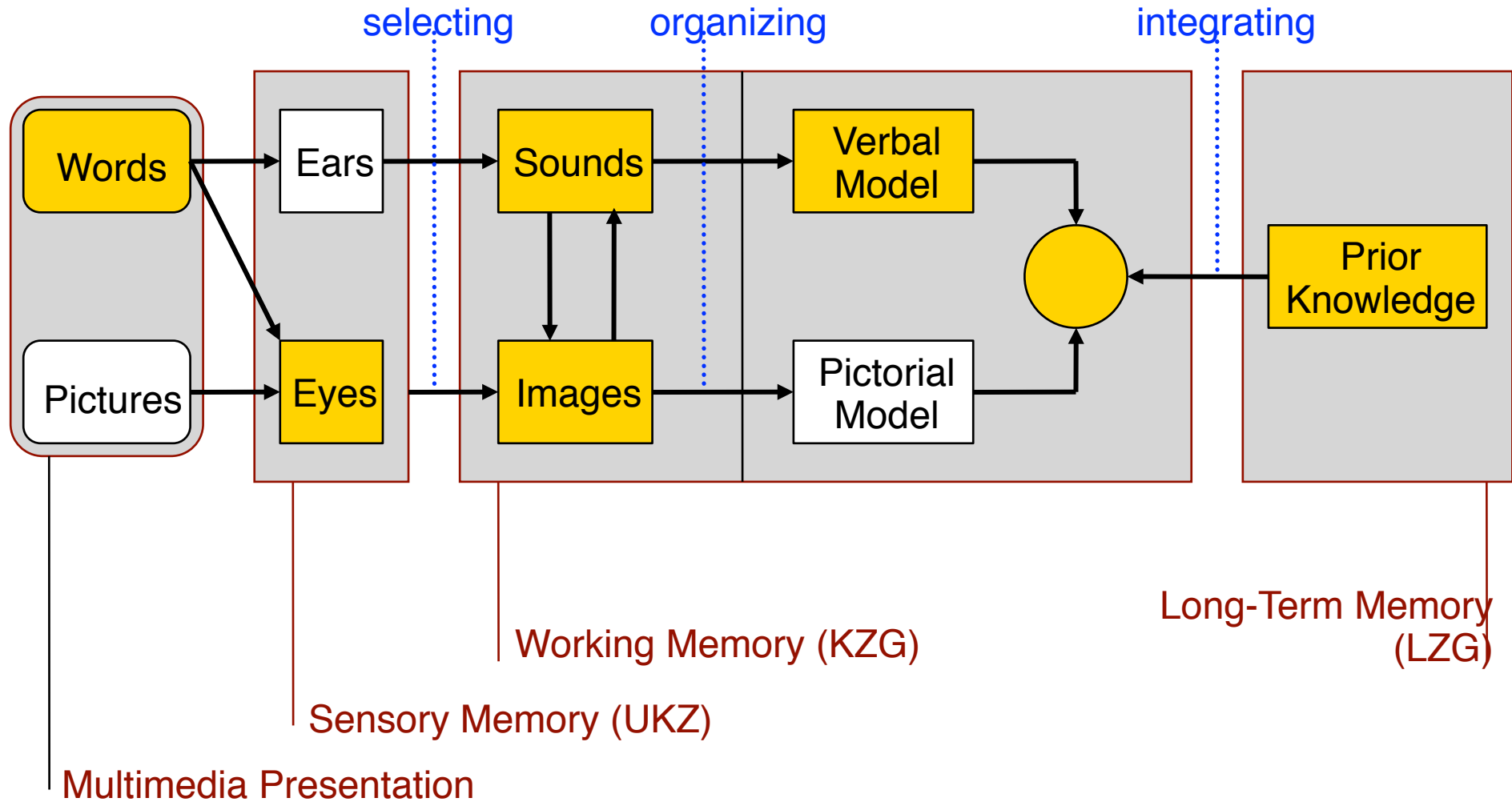

Goals of Multimedia Learning

- Two different effects of learning can be measured:
- *Retention*
 - Remembering
 - Ability to reproduce or recognize presented material
 - Example test: “Write down all you can remember from the passage you just read”
- *Transfer*
 - Understanding
 - Ability to use presented material in new situations
 - Example test: “List some ways to improve the reliability of the device you just read about”

Example: “Multimedia” Instructional Message

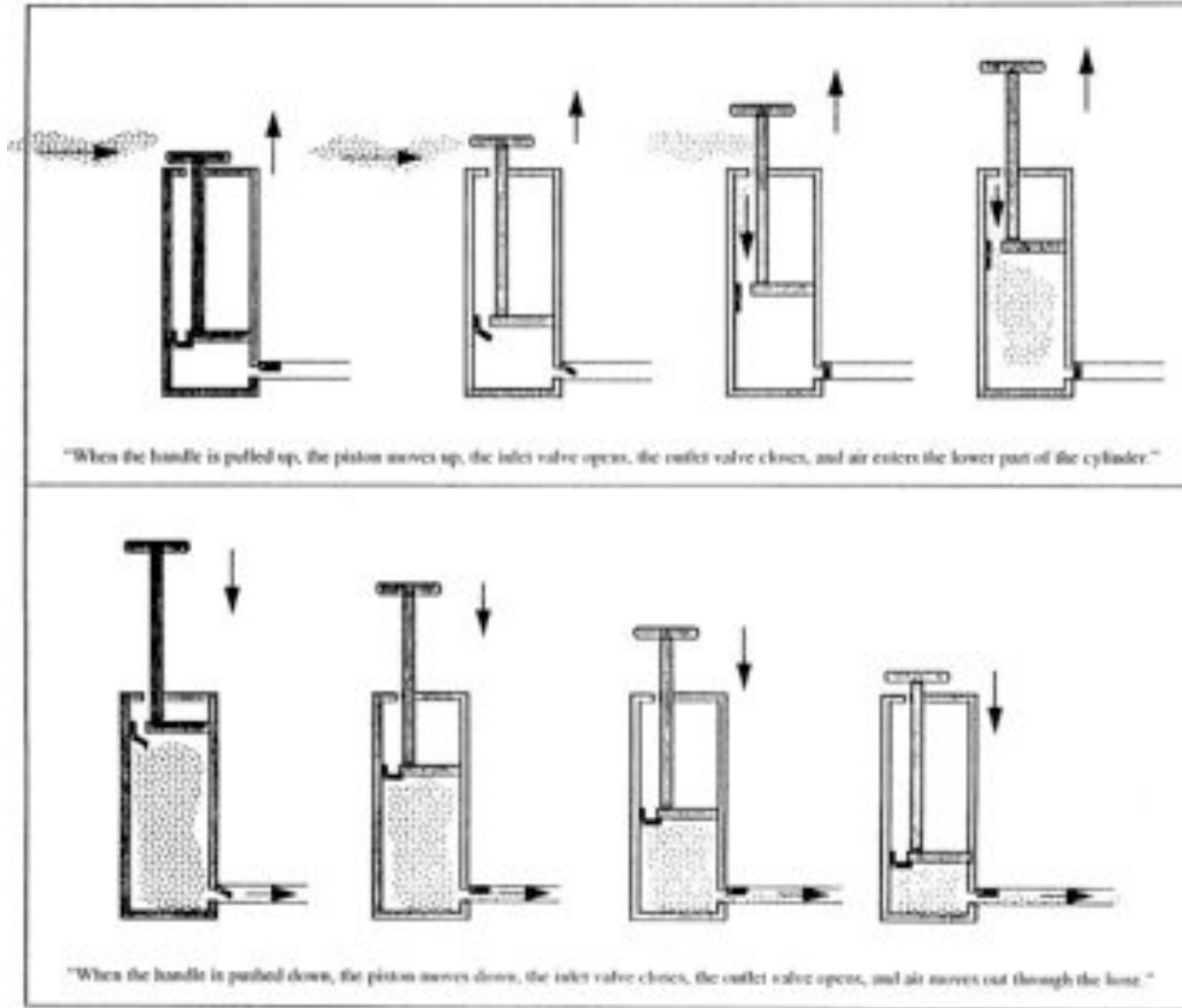

Example: Retention and Transfer Tests

- Retention Test:
 - “Please write down an explanation of how a bicycle tire pump works. Pretend that you are writing to someone who does not know much about pumps.”
- Transfer Test:
 1. “What could be done to make a pump more reliable – that is, to make sure it would not fail?”
 2. “What could be done to make a pump more effective – that is, to make it move more air more rapidly?”
 3. “Suppose you push down and pull up the handle of a pump several times but no air comes out. What could have gone wrong?”
 4. “Why does air enter a pump? Why does air exit from a pump?”

5 Theorien und Untersuchungen zum multimedialen Lernen

5.1 Multimediales Lernen: Erwartungen und Realität

5.2 Modelle der kognitiven Verarbeitung von Multimedia

5.3 Cognitive Theory of Multimedia Learning 

5.4 Methodische Fragen zu Lerntheorien

5.5 Alternative Theorien des Multimedia-Lernens

Literatur:

Richard E. Mayer: Multimedia Learning, Cambridge University Press 2001

Richard E. Mayer (ed.): The Cambridge Handbook of Multimedia Learning, Cambridge University Press 2005

Are Pictures Different from Words?

- *Pro Words:*
 - Most common way of presenting information
 - Pictorial presentation conveying the same information is waste of effort
 - Prediction on experiments: Students who receive presentation only in words should perform equivalently to students receiving presentation in words and pictures
- *Pro Combination of Words and Pictures:*
 - Humans have two different channels to process presented material
 - Words and pictures: qualitatively different systems for representing knowledge
 - » Words: abstracted and interpreted presentations
 - » Pictures: "original" mode of knowledge representation for humans
 - Prediction on experiments: Students who receive presentation in words and pictures will perform better than those receiving words only
 - » At least in transfer tests
 - » Possibly even in (word-based) retention tests

Words & Pictures & ...

As the rod is pulled out, air passes through the piston and fills the area between the piston and the outlet valve. As the rod is pushed in, the inlet valve closes and the piston forces air through the outlet valve.

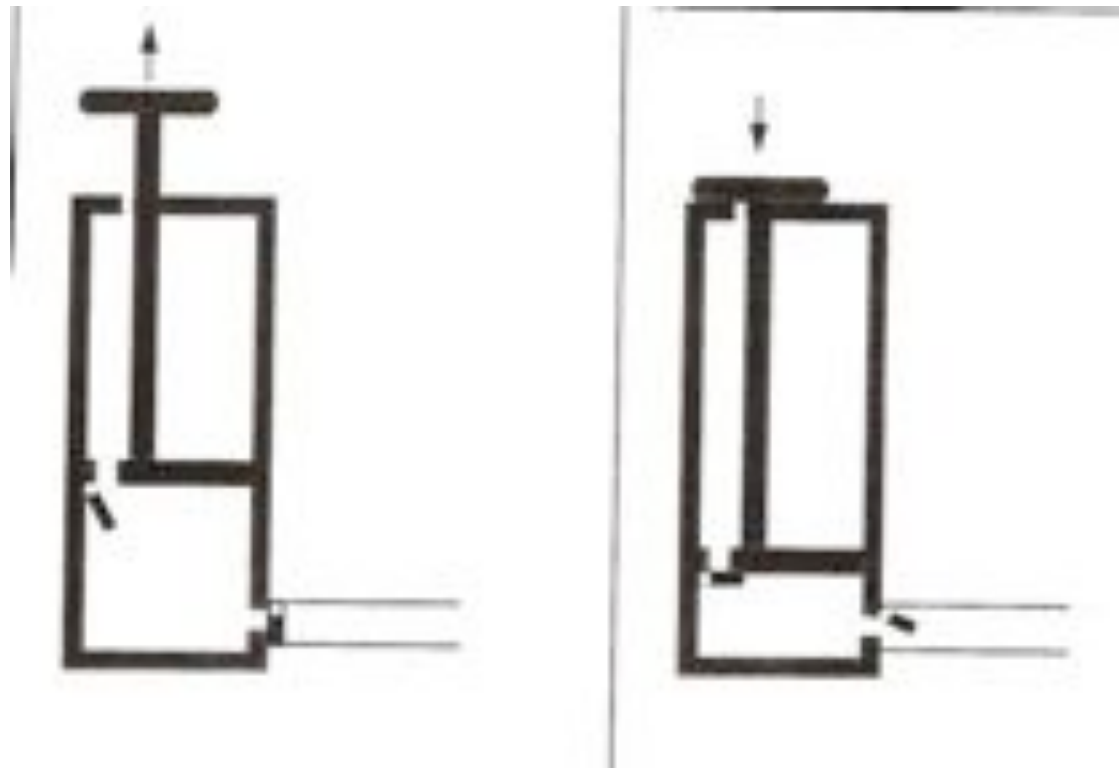

Words & Pictures & Combination

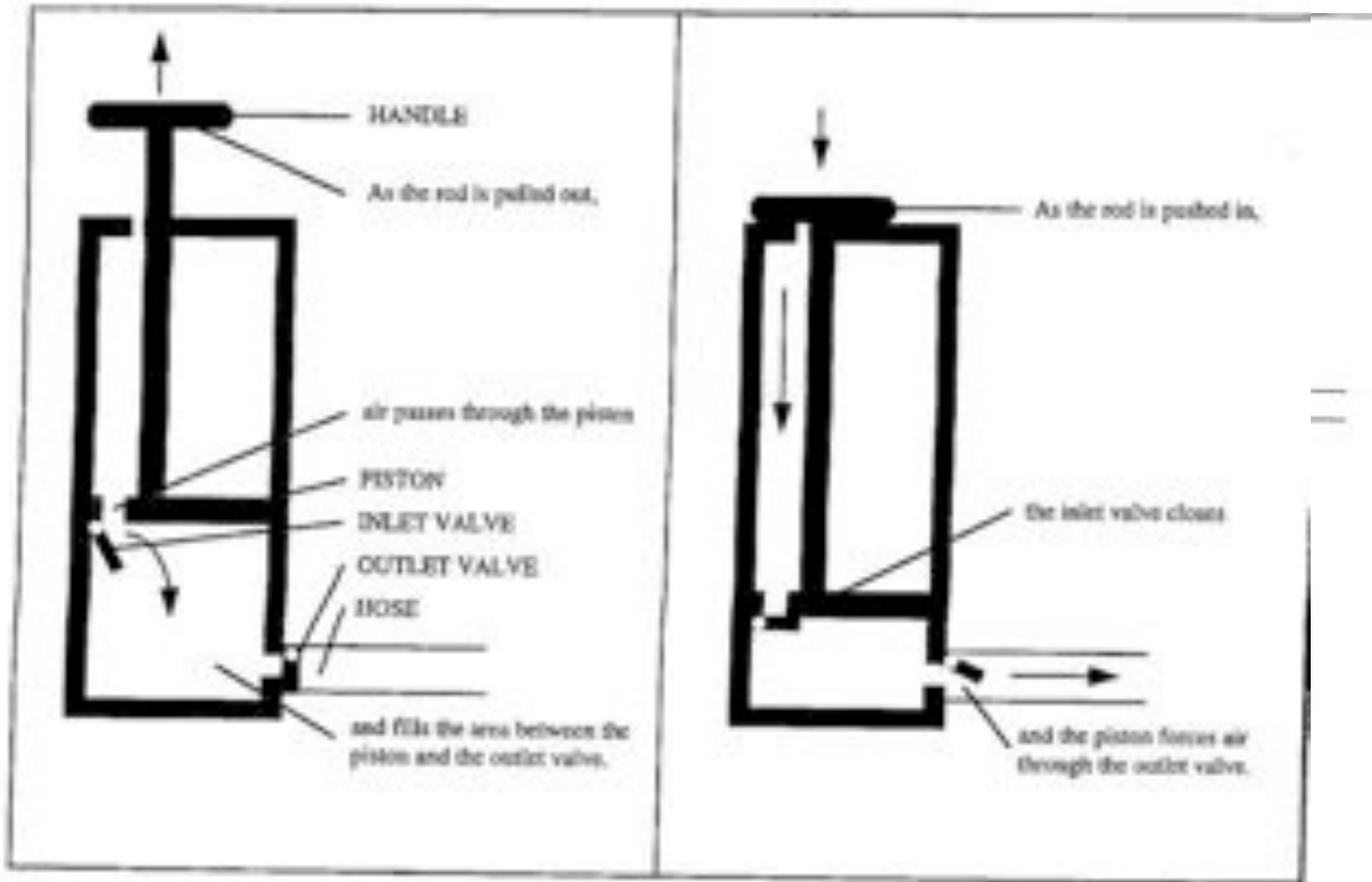

Experimental Results on Multimedia Principle (1)

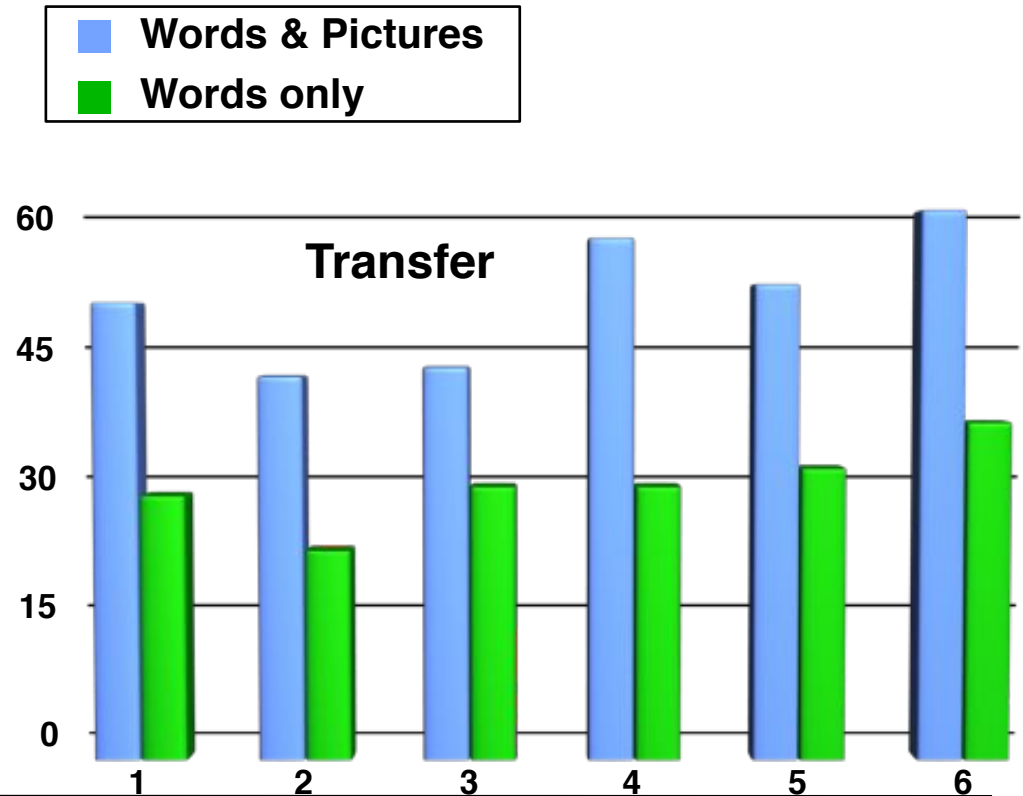
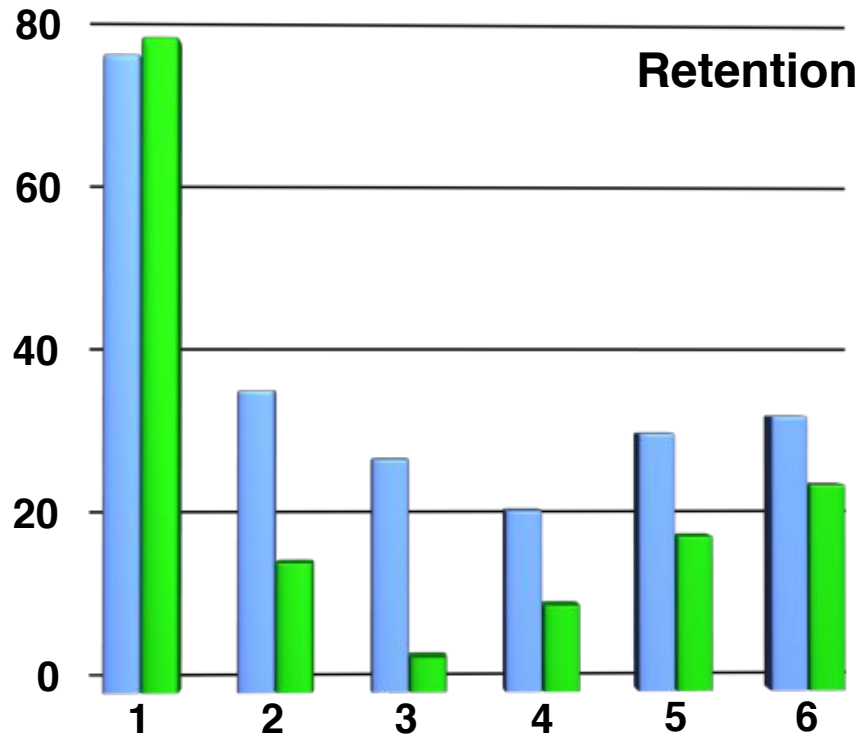

Mayer & Anderson 1991

Narrated Animation

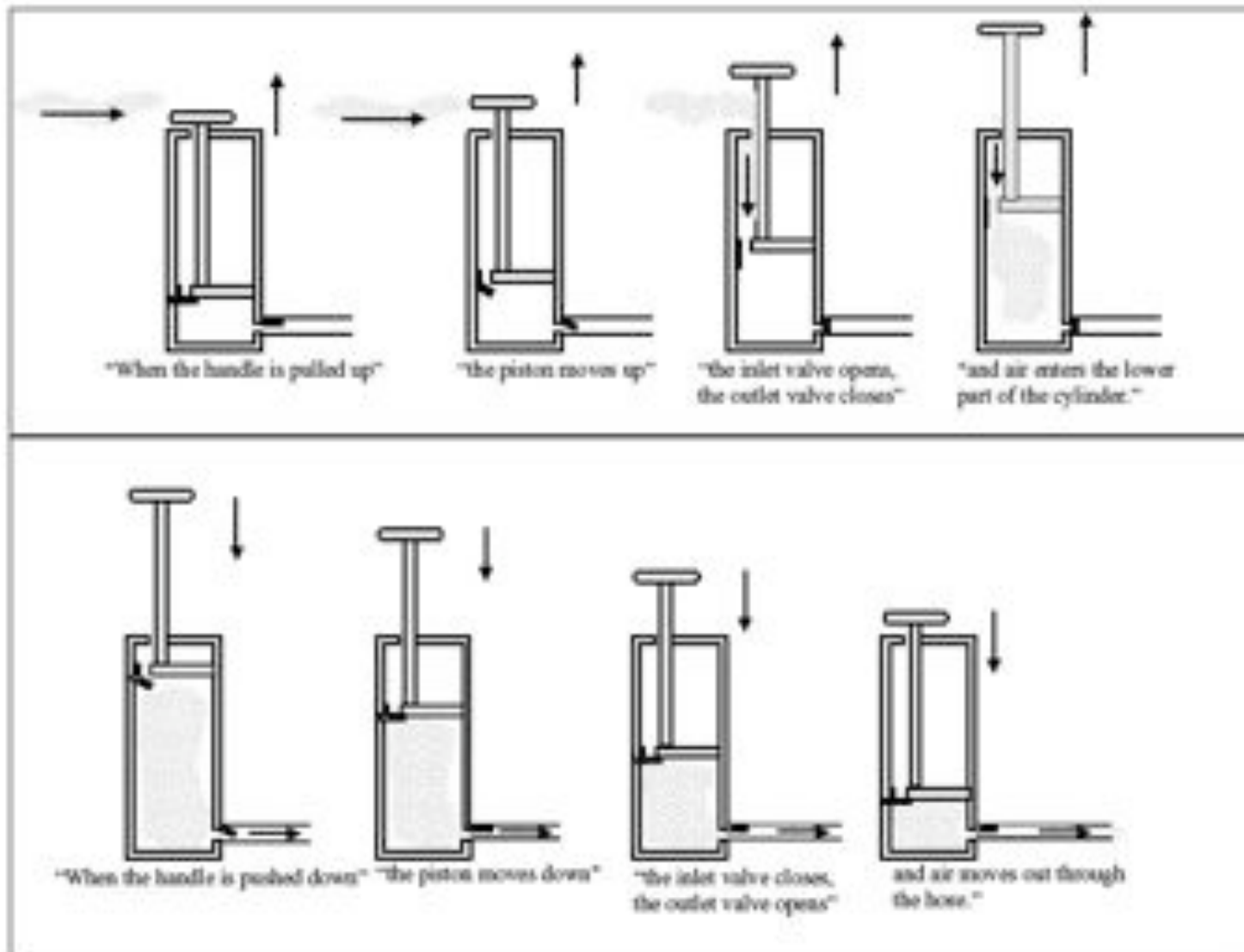

Experimental Results on Multimedia Principle (2)

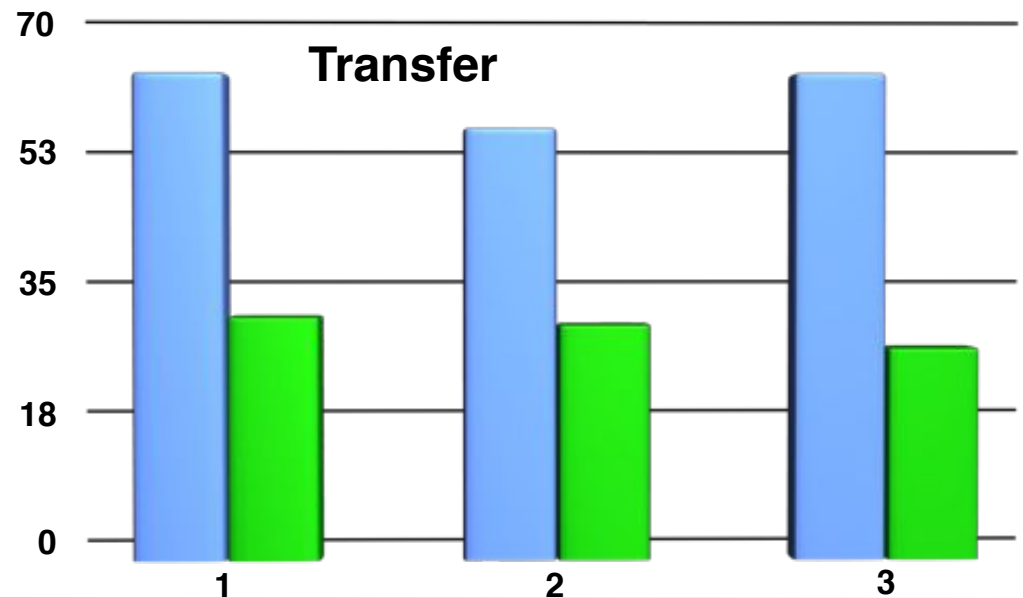
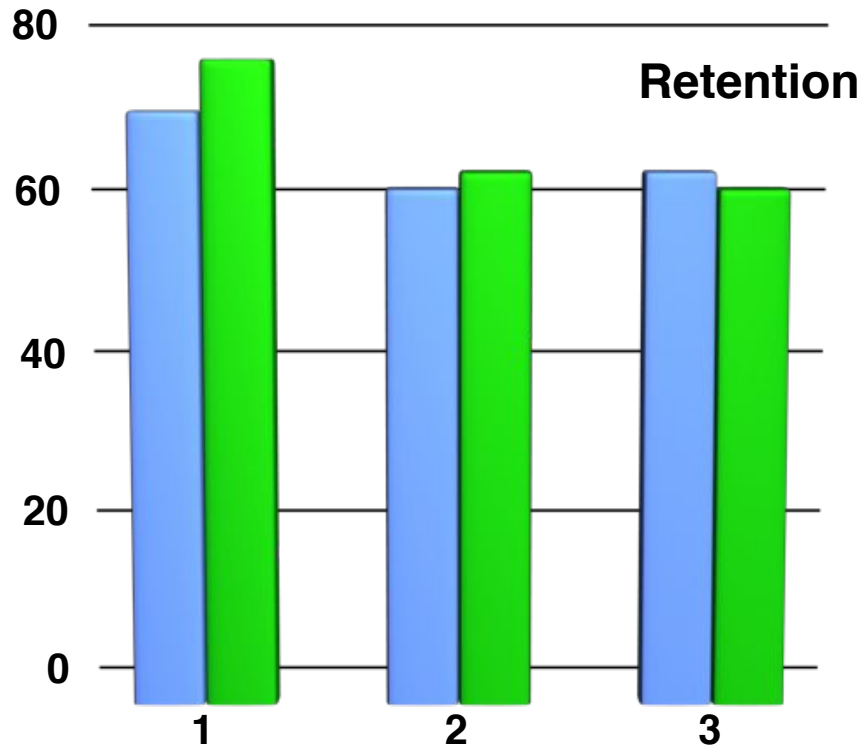

Mayer & Anderson 1991

Easing Integration of Mental Images

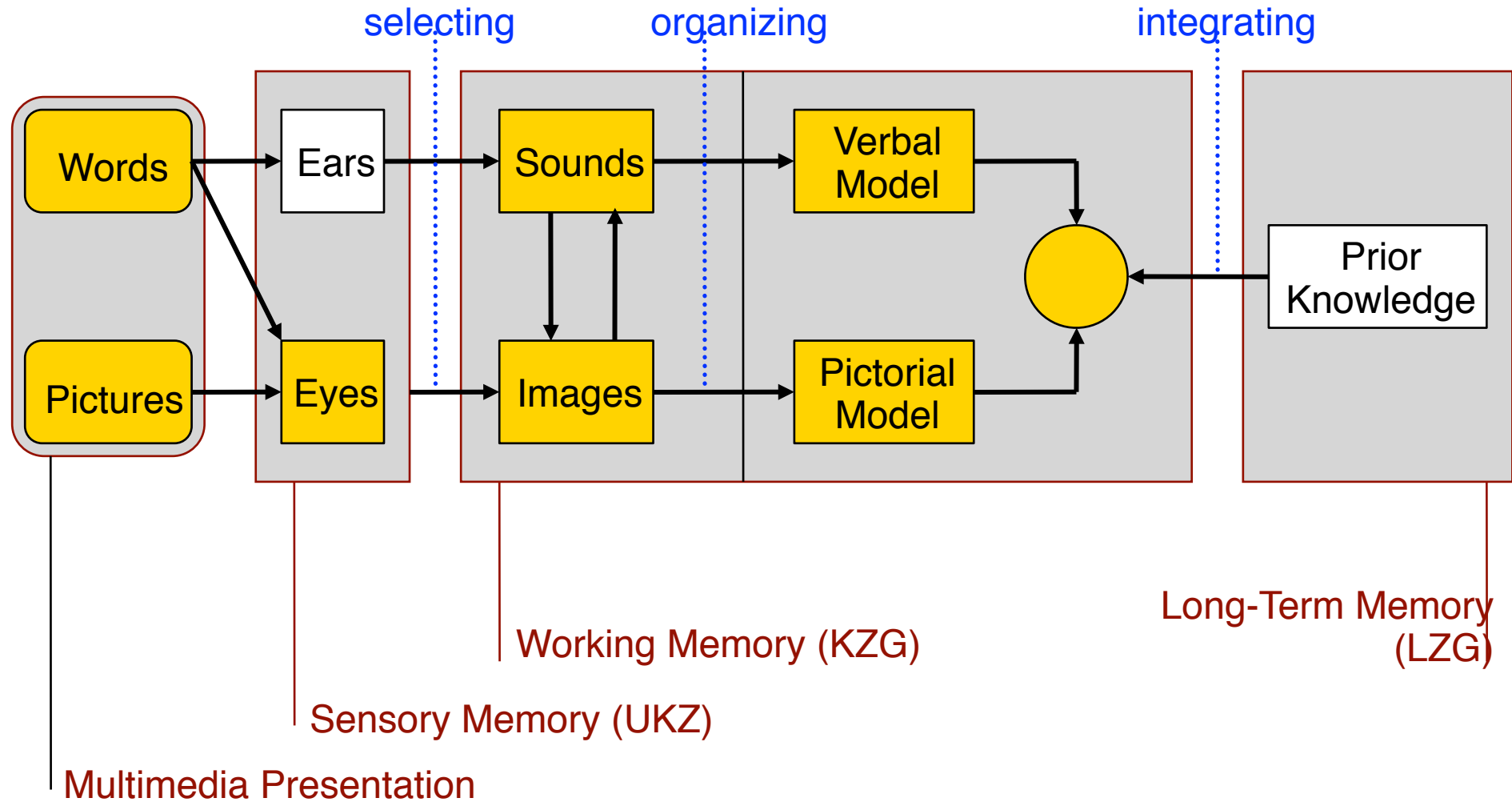

Multimedia Principle

- Mayer et al 1991:
 - Cognitive load on constructive process can be reduced by multicodality
 - » Connecting verbal and pictorial images: demanding process
 - Empirical evidence exists
 - Cognitive model can predict the effect
- Applicable only under limitations!
 - Under some conditions adding pictures is harmful ...
- CTML by Mayer et al.:
 - Many different “principles” of this style
 - Here: Selection of a few interesting principles

Instructional Split-Attention

- Tarmizi, Sweller 1988:
 - Proven strategies for presenting worked geometry examples fail in some experiments
 - » No increase in learner performance
 - Dependence on the format of the presentation !

Split presentation

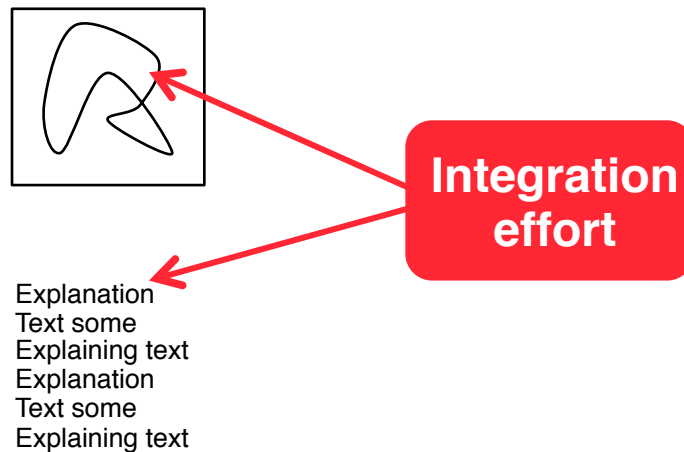

Integrated presentation

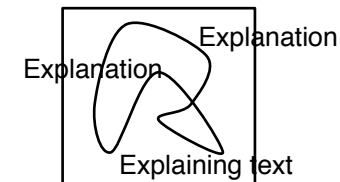

Integration of Mental Images

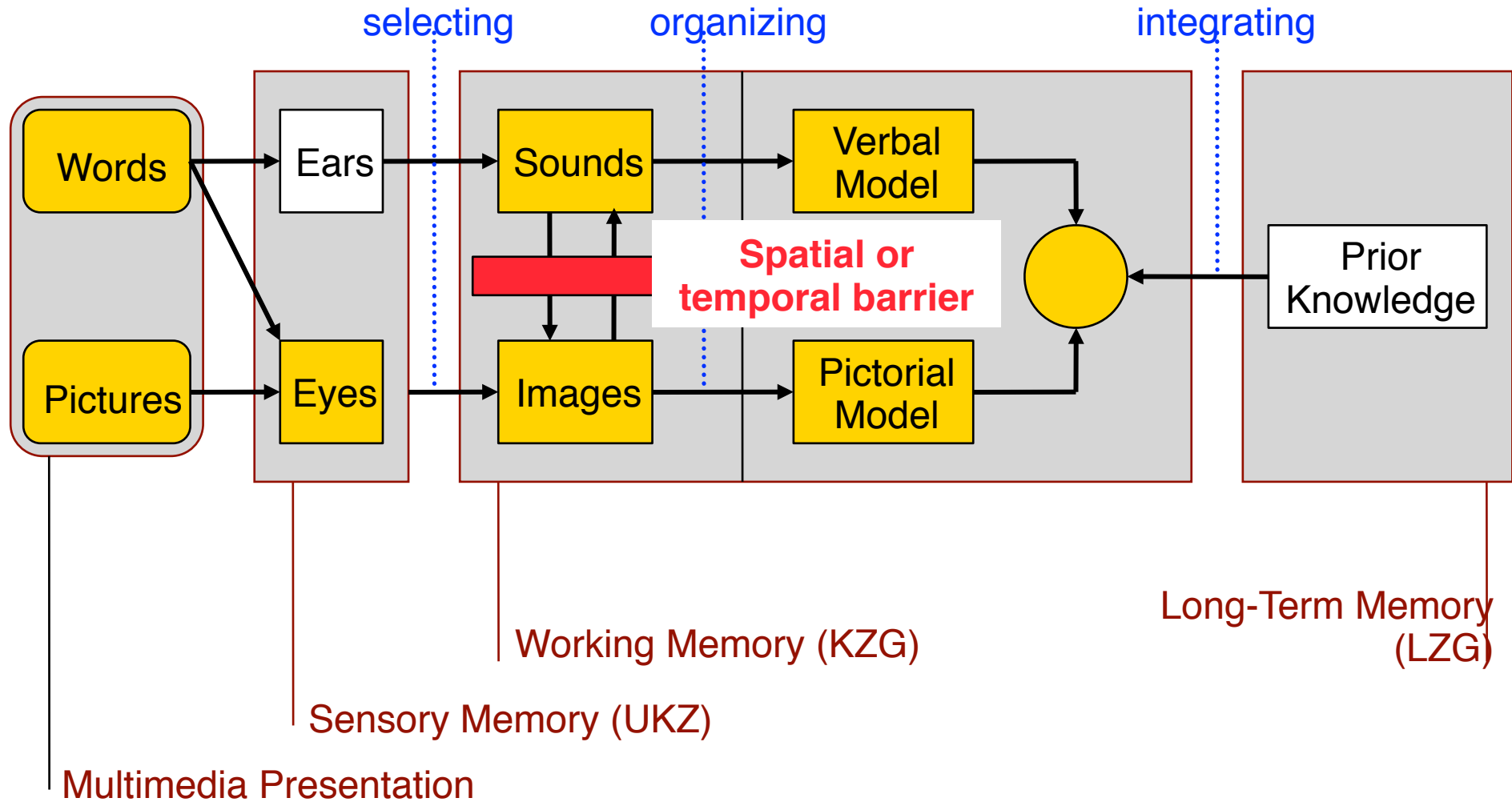

Spatial Contiguity Principle

- Students learn better when corresponding words and pictures are presented near each other than far from each other on the page or screen.
- Mayer et al. 1989 – 1995
- Comparison of
 - "integrated" text/animation
 - "separated" text & animation
- Retention and transfer results consistently better for integrated presentation

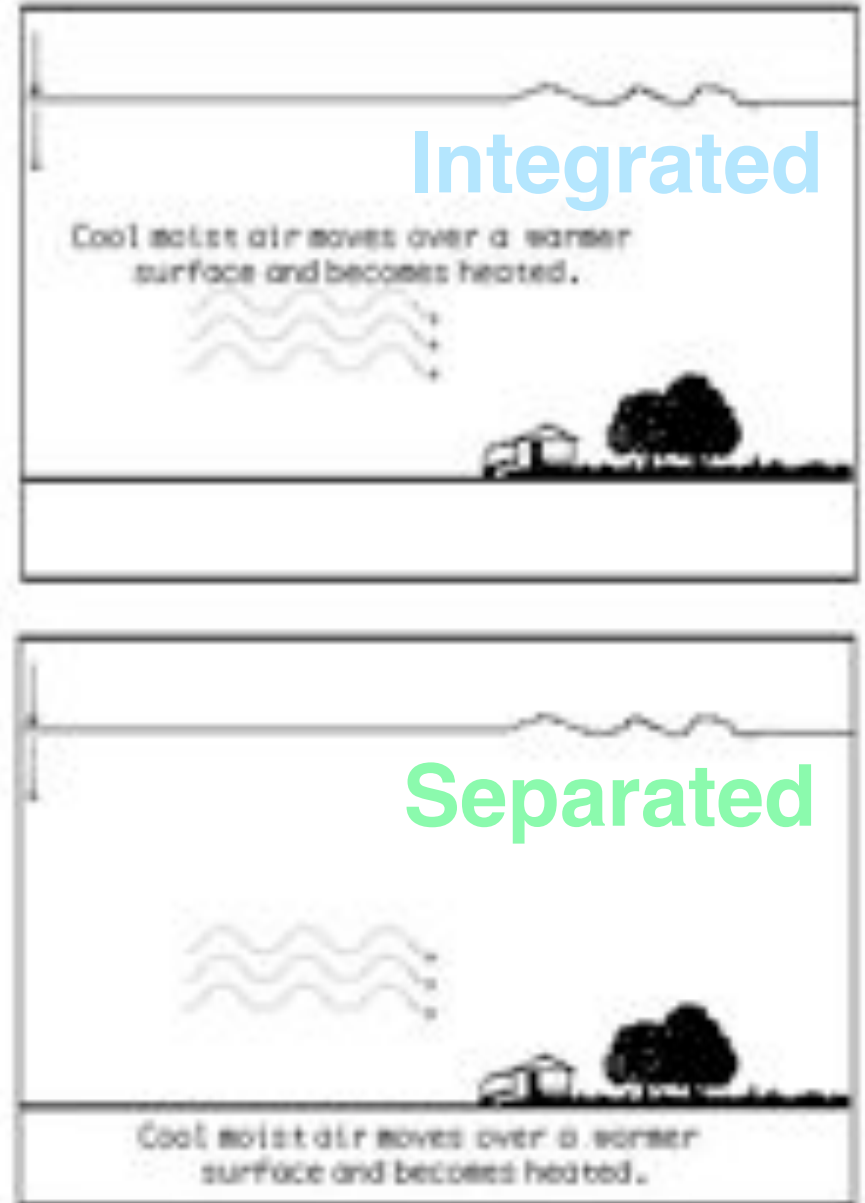

Temporal Contiguity Principle

- Students learn better when corresponding words and pictures are presented simultaneously rather than successively.
- Mayer et al. 1991– 1999
- Experiment:
 - 16-sentences narration followed by a pictorial animation vs.
 - Animation in parallel with narration
- Results:
 - Retention: Parallel version only slightly superior (3 out of 5)
 - » Sequential version =
Better preparation for purely verbal reproduction of information?
 - Transfer: Parallel version consistently and significantly superior
- Variation:
 - 16 small segments of narration followed by small step of animation
 - » Effect almost equivalent to parallel presentation

Modality Principle

- Students learn better from animation and narration than from animation and on-screen text.
 - Students learn better when words in a multimedia message are presented as spoken text rather than printed text.
- Mayer et al. 1998 – 2001
- Experiment:
 - Animation accompanied with text
 - » As on-screen (separated) text, small segments, vs.
 - » As audio narration
- Results:
 - Consistent and clear superiority for narration, in retention and transfer

Cognitive Overload by Monomodal Presentation

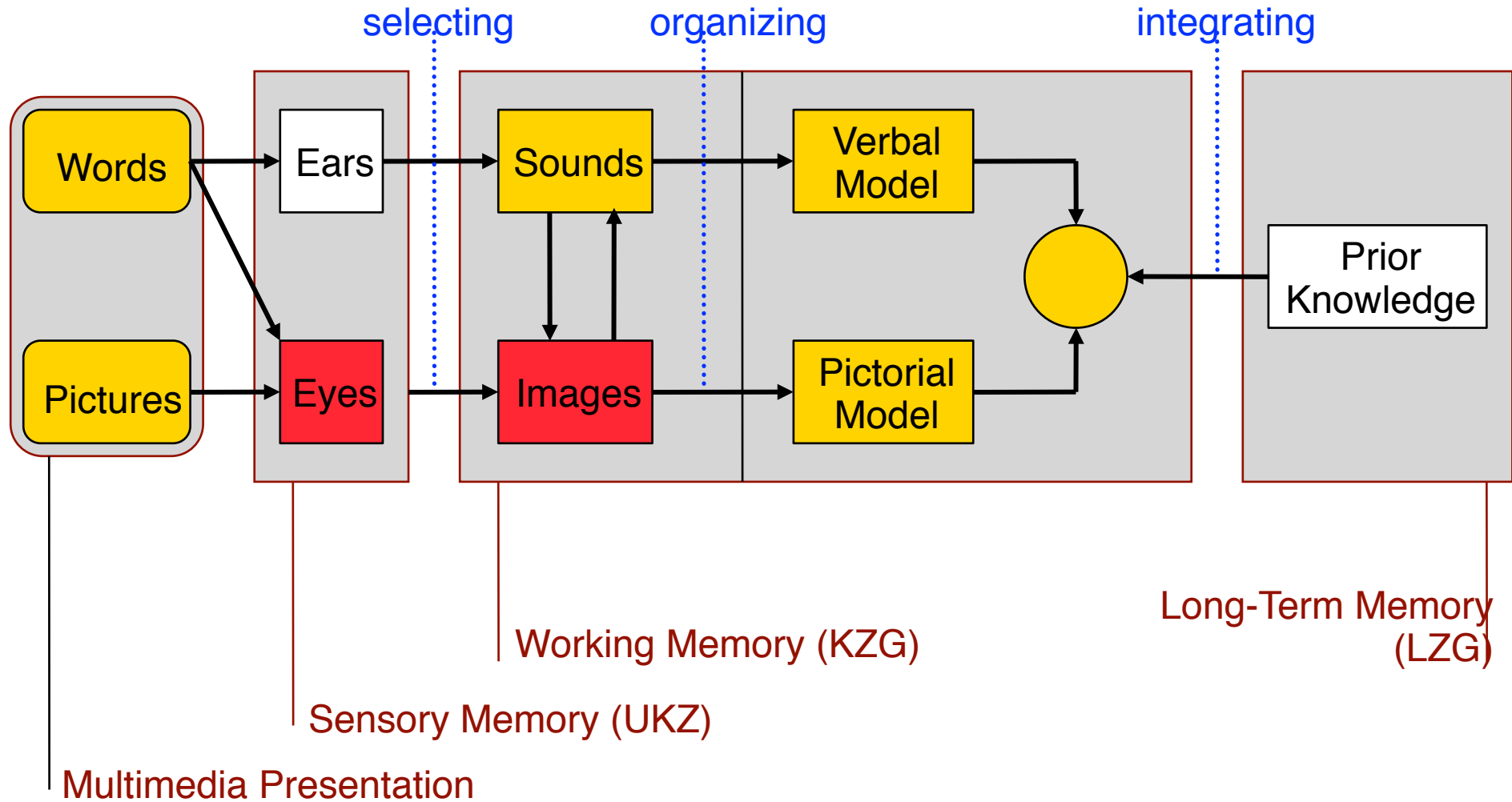

Less Cognitive Load by Multimodal Presentation

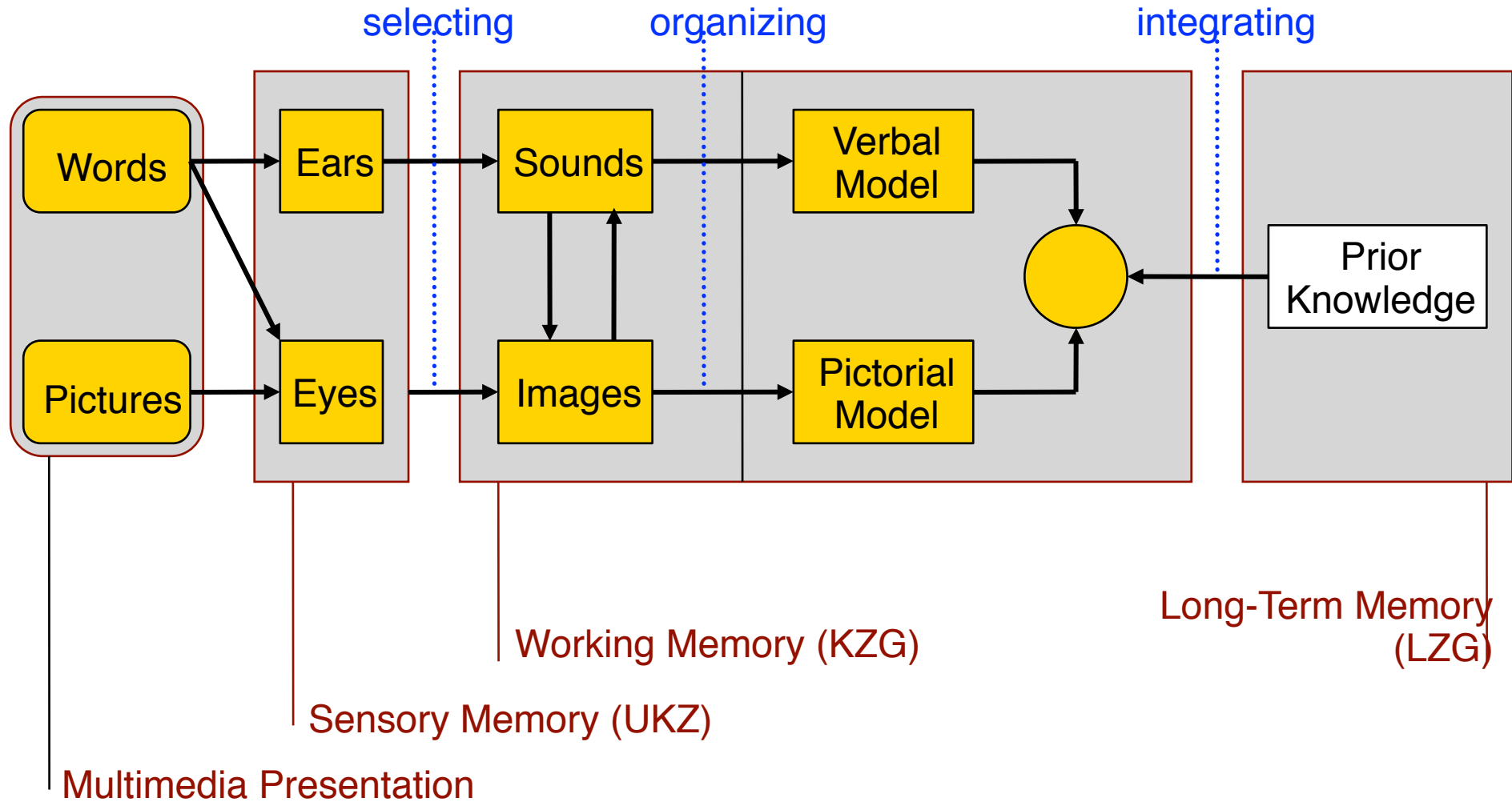

Coherence Principle, Type 1 (Visual)

- Students learn better when extraneous material is excluded rather than included.
 - Version 1: Student learning is *hurt* when interesting but irrelevant words and pictures are added to a multimedia presentation
- Harp & Mayer 1998
 - "seductive text", "seductive illustrations":
 - Topically relevant, but conceptually irrelevant
 - Learners regard the extraneous material as entertaining and interesting
 - Cognitive load is increased by extraneous material
- Arguments *pro* addition of seductive details:
 - Arousal theory: students are emotionally aroused and therefore learn better
 - Improvement of information acquisition or of knowledge construction?
- Arguments *contra* addition of seductive details:
 - Dewey (1913): "When things have to be made interesting, it is because interest itself is wanting."
 - Cognitive interest (enjoying to understand) is better than "surface" interest

Example: Interesting but Irrelevant Additions

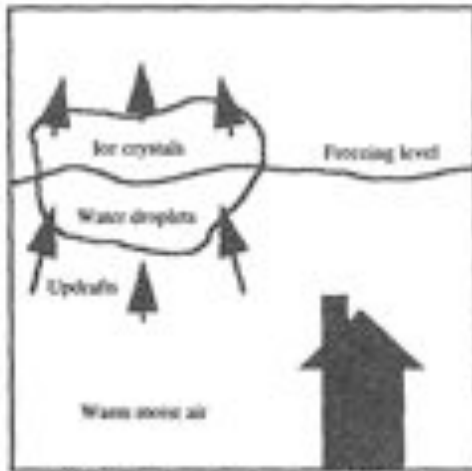

Warm moist air rises, water vapor condenses and forms a cloud.

When the surface of the earth is warm, moist air near the earth's surface becomes heated and rises rapidly, producing an updraft. As the air in these updrafts cools, water vapor condenses into water droplets and forms a cloud. When flying through updrafts, an airplane ride can become bumpy. Metal airplanes conduct lightning very well, but they sustain little damage because the bolt, meeting no resistance, passes right through. The cloud's top extends above the freezing level. At this altitude, the air temperature is well below freezing, so the upper portion of the cloud is composed of tiny ice crystals.



Metal airplanes conduct lightning, but sustain little damage.

Experimental Results on Coherence Principle (1)

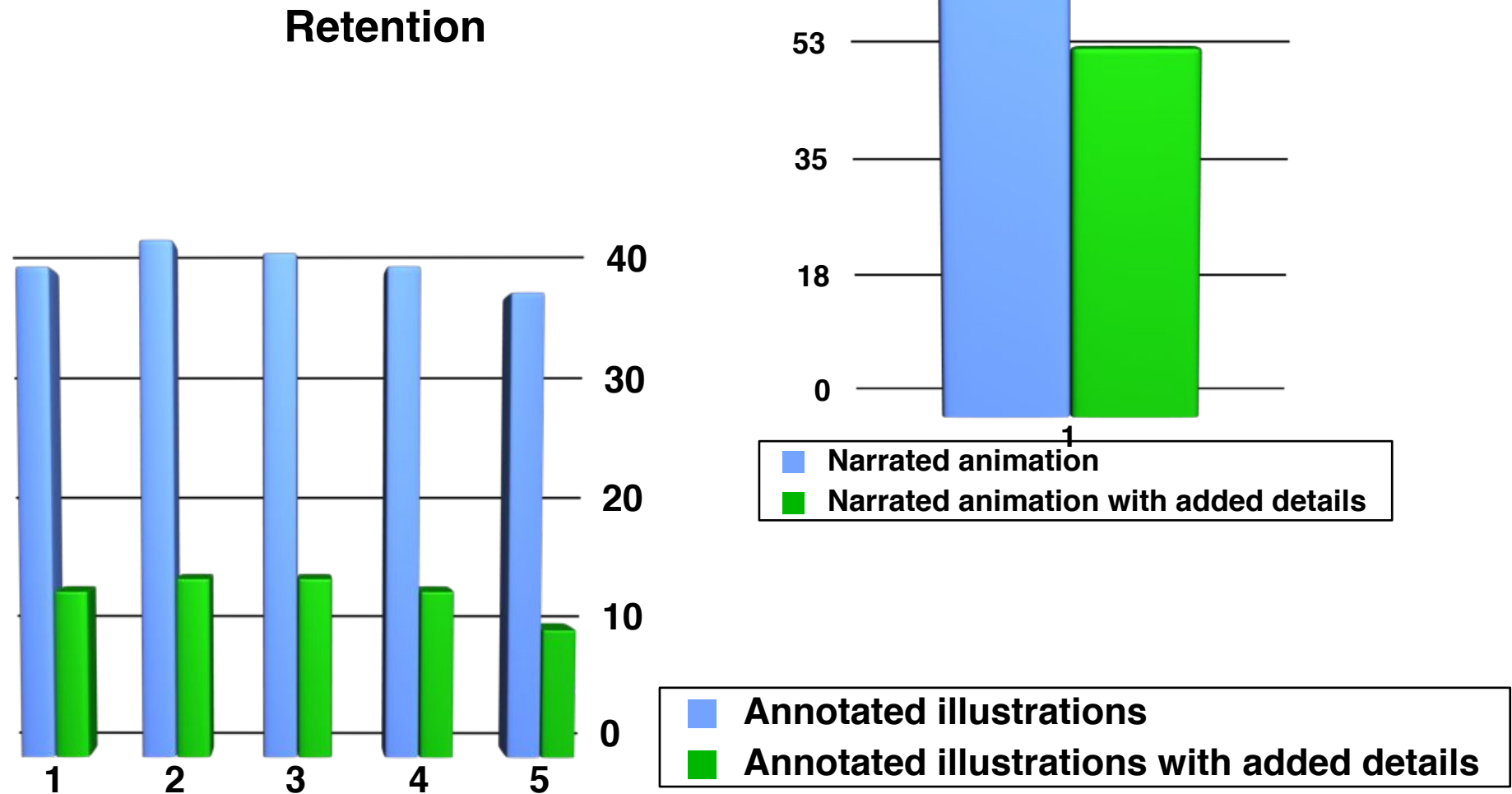

Experimental Results on Coherence Principle (2)

Transfer

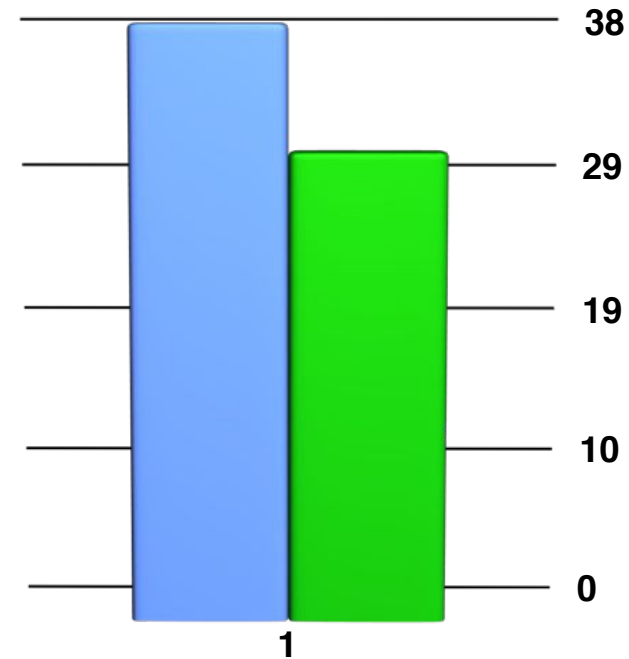
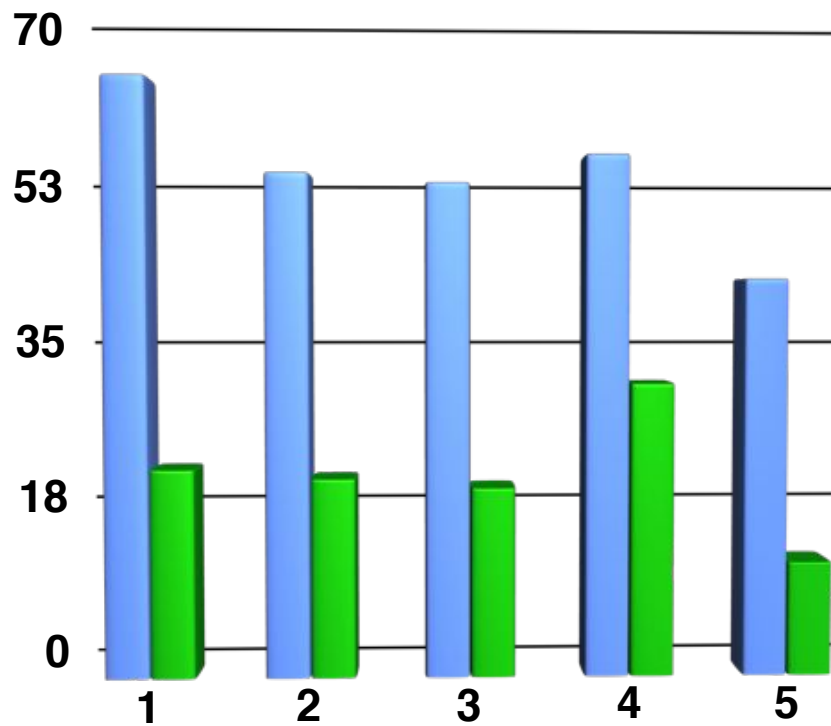

Coherence Principle, Type 2 (Visual-Auditive)

- Students learn better when extraneous material is excluded rather than included.
 - Version 2: Student learning is *hurt* when interesting but irrelevant sounds and music are added to a multimedia presentation
- Harp & Mayer 2000
 - Using a presentation with picture animation and *narrated text*
 - Add gentle background music loop
 - Add environmental sounds (e.g. blowing wind, crackling ice cubes)
- Arguments *pro* extraneous sound additions:
 - Arousal theory (fun, playful elements)
 - Relaxation
- Arguments *contra* extraneous sound additions:
 - Limited capacity in auditory processing channel
 - Extraneous sound competes with narration for processing capacity
- Experimental Results:
 - Clearly better retention & transfer when additional sounds omitted

Cognitive Analysis of Coherence Principle Type 2

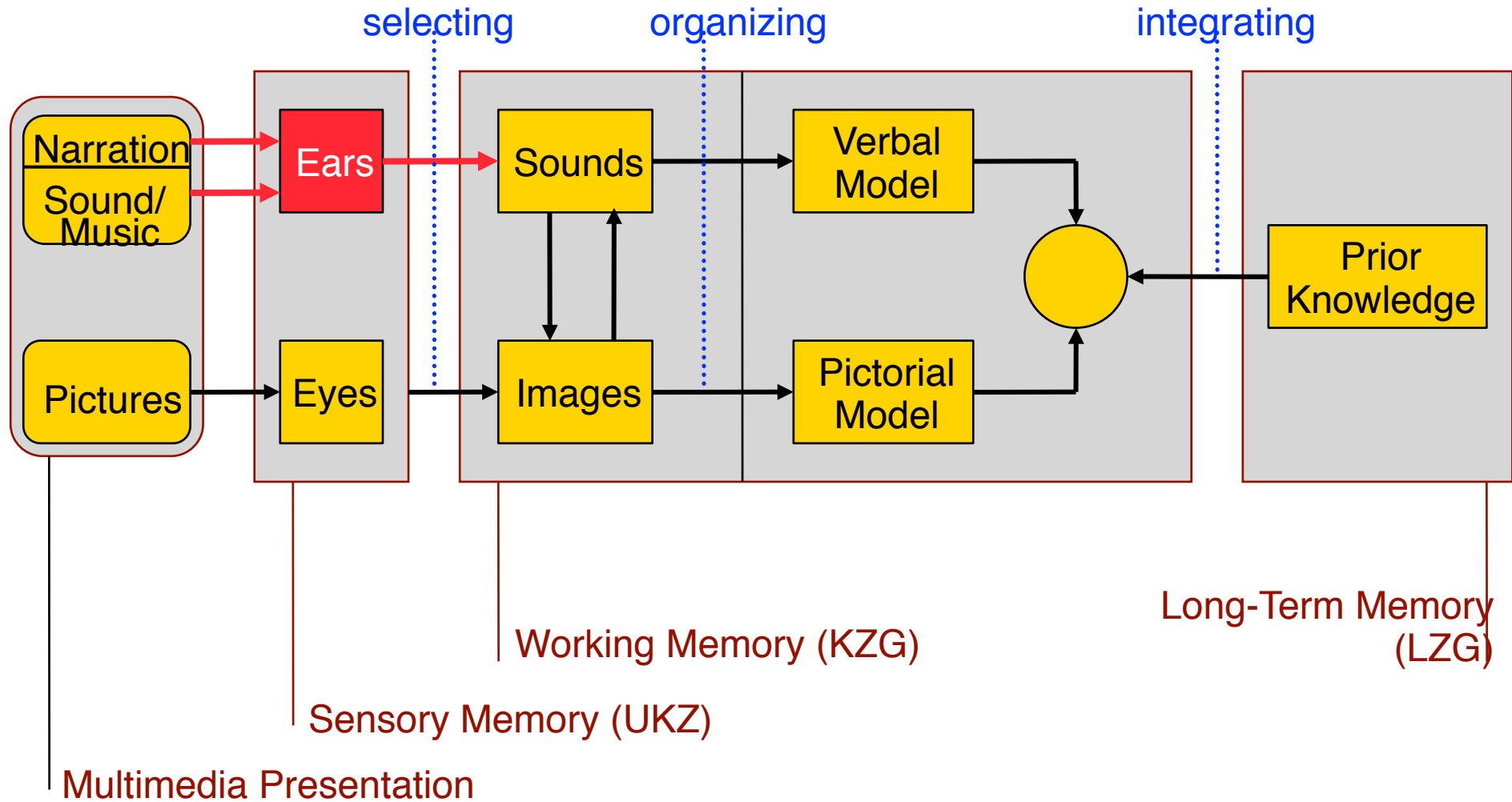

Experimental Results on Coherence Principle (3)

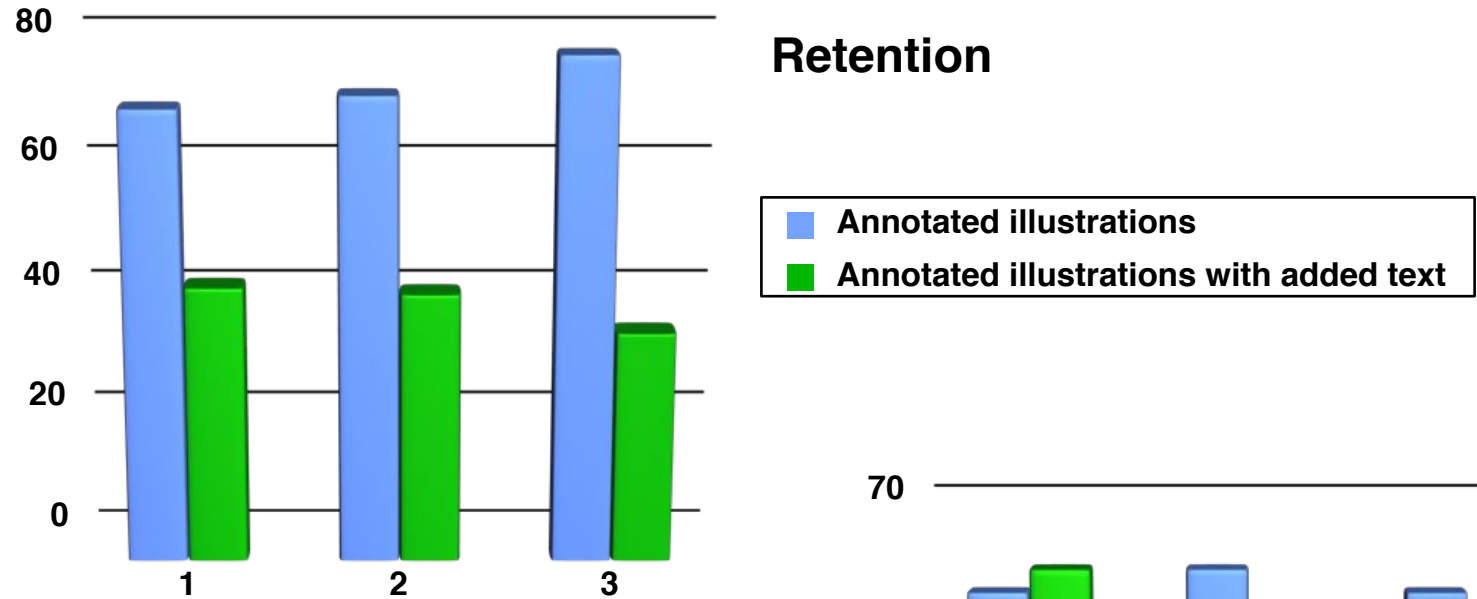

"... shows that the coherence effect sizes are consistent and moderate, with a median of .70, and students who received the summary version ... generated a median of 28% more creative solutions than did students who received the full version."
(Mayer 2001, p.131)

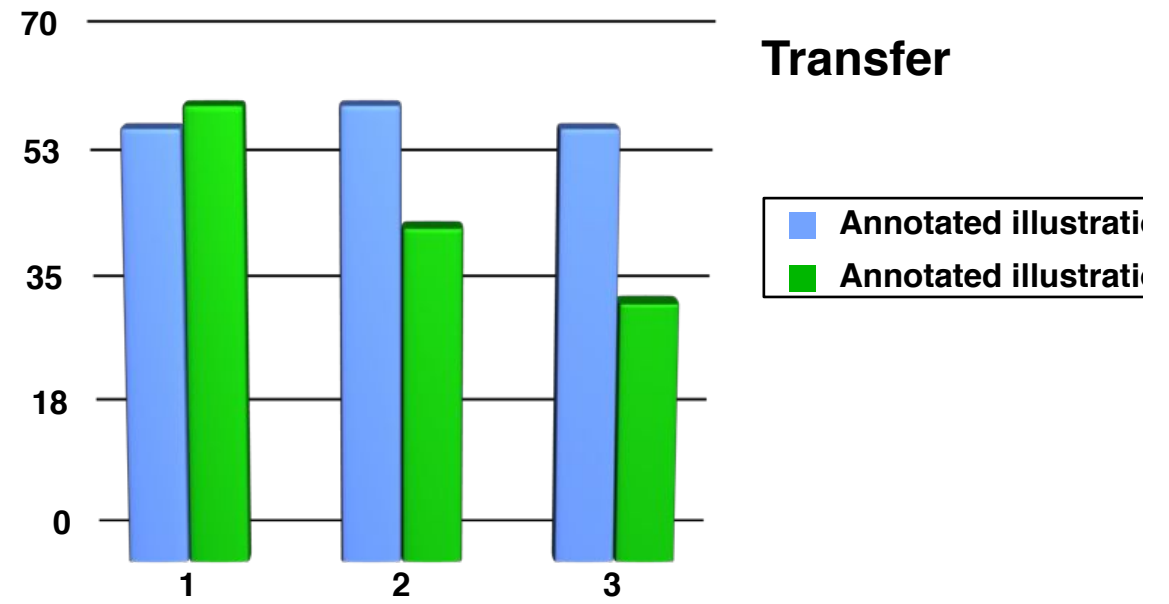

Redundancy Principle

- Formulation of the Redundancy Principle in Mayer (2001):
 - Students learn better from animation and narration than from animation, narration, and text
- Redundancy principle in Multimedia Learning according to Sweller (2005):
 - More general:
 - » "Redundant material interferes with rather than facilitates learning."
 - » "Redundancy effect occurs when additional information presented to learners results in learning decrements..."
 - Variant (1):
 - » Identical information presented in two or more different forms or media
 - Variant (2): (= Coherence Principle of Mayer, 2001)
 - » Additional information is presented within the given forms and media in an attempt to enhance or elaborate information

History of the Redundancy Principle



- Miller (1937)
 - Word "cow" spoken and read
 - Word "cow" spoken, read and picture shown
 - Reading test was always better for teaching *without* pictures!
- Frequent replications of the effect...
- Reder, Anderson (1980-82):
 - Full text of textbook chapters (geography, linguistics, economy etc.)
 - Summaries of the text (20% length)
 - "To our surprise, all ... experiments indicated that subjects learn information better when they read an abridged or summarized version of the original text than when they read the original chapter."
- Carroll et al. (1990):
 - "The minimal manual"

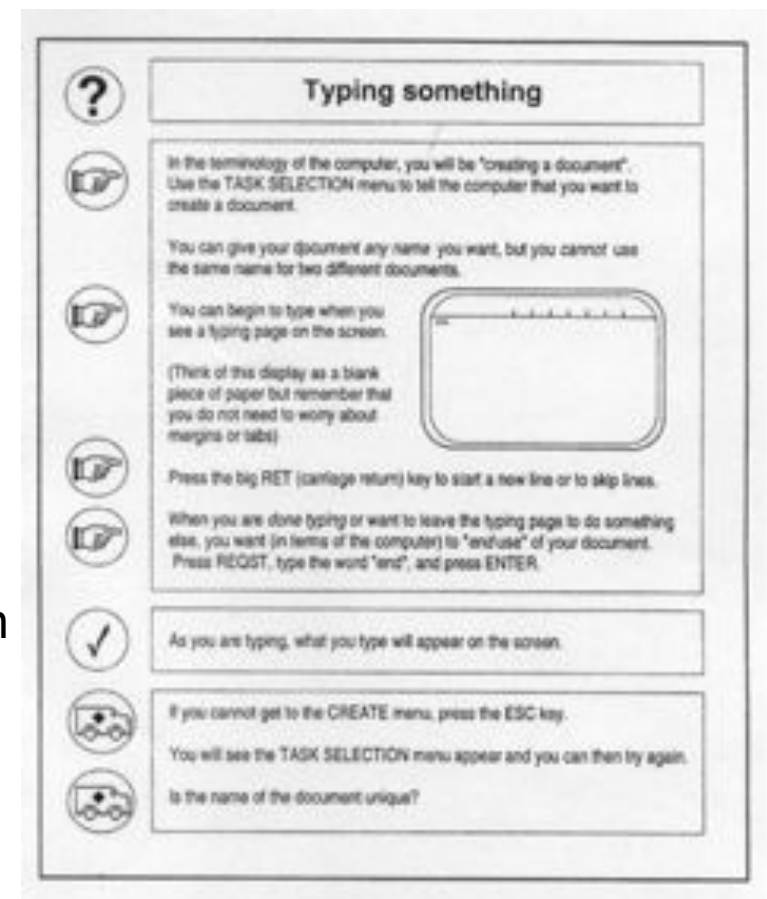

Multimedia Redundancy Effect



- Audio narration plus video animation
 - Balanced combination
 - Load distributed between auditory and visual channels
- Audio narration plus video animation plus on-screen text
 - Animation and text compete for the visual channel
 - Overall effect **worse** than for a subset of the presentation forms