

## 2. Visual Perception: Optimizing Information Visualization regarding the human visual system

Vorlesung „Informationsvisualisierung“

Prof. Dr. Andreas Butz, WS 2011/12

Konzept und Basis für Folien: Thorsten Büring

# Outline

- Perception Definition & Context
- Preattentive processing
- Gestalt Laws
- Change Blindness
- Data encoding – glyphs
- Data encoding – color
- Characteristics of Visual Properties

# Perceptual Processing

- Design visual information to be efficiently perceivable – quick, unambiguous
- Need to understand how human visual perception and information processing works
- Perception science related to:
  - Physiology: study the physical, biochemical and information processing functions of living organisms
  - Cognitive psychology: studying internal mental processes
    - how do people learn, understand, solve problems with regard to sensory information?

# Model of Perceptual Processing

- Numerous other models exist
- Simplified 3-stage model: many subsystems involved in human vision
- Stage 1 – rapid parallel processing to extract low-level properties of a visual scene
  - Detection of shape, spatial attributes, orientation, color, texture, movement
  - Billions of Neurons work in parallel, extracting information simultaneously
  - Occurs automatically, independent of (cognitive) focus
  - Information is transitory (though briefly held in a short-lived visual buffer)
  - Often called “preattentive” processing

# Model of Perceptual Processing

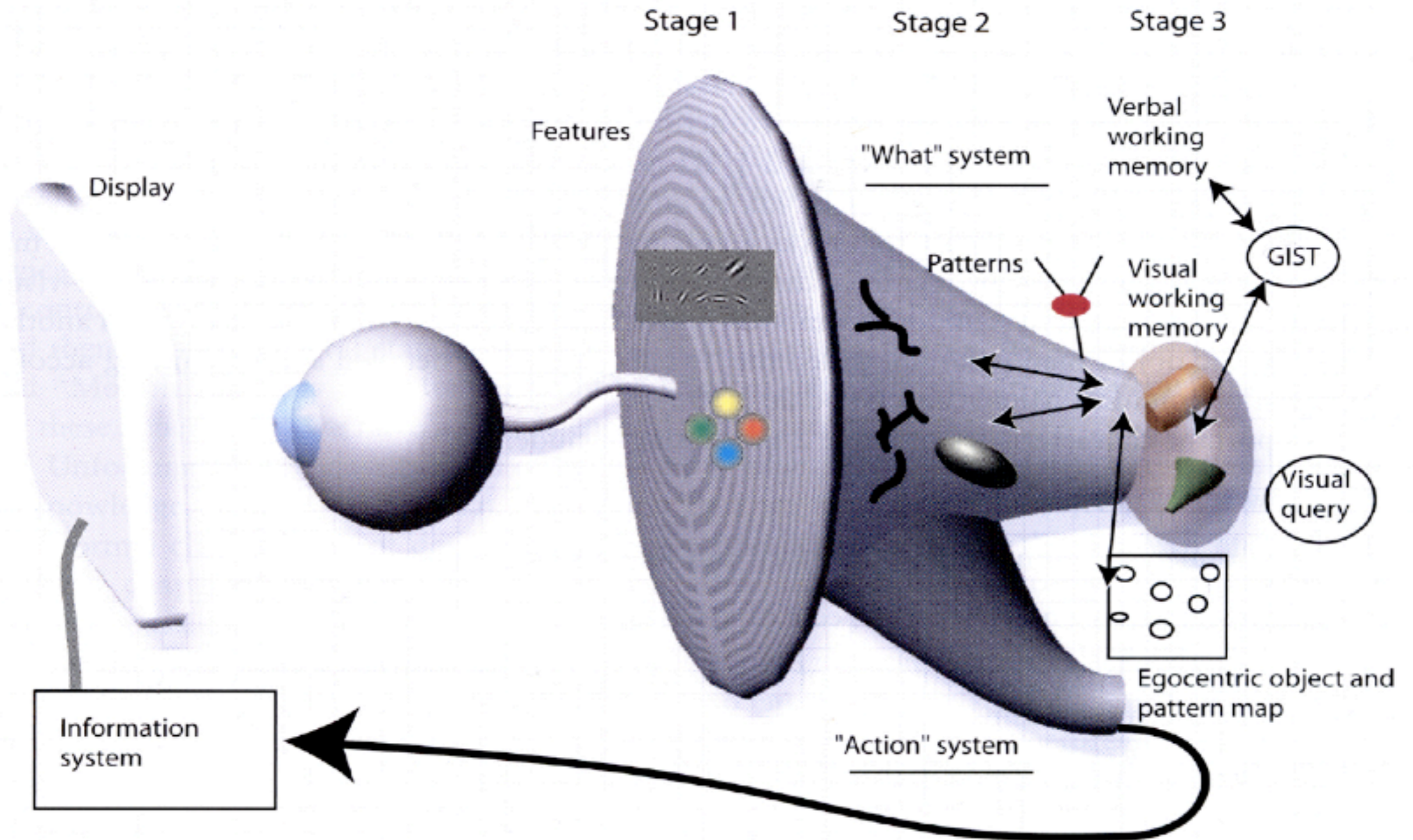

Image taken from Ware 2001

# Model of Perceptual Processing

- Stage 2 – pull out structures via pattern perception
  - Visual field is divided in simple patterns: e.g. continuous contours, regions of the same color / texture
  - Object recognition
  - Slower serial processing
- Stage 3 – sequential goal-directed processing
  - Information is further reduced to a few objects held in visual working memory
  - Used to answer and construct visual queries
  - Attention-driven - forms the basis for visual thinking
  - Interfaces to other subsystems:
    - Verbal linguistic: connection of words and images
    - Perception-for-action: motor system to control muscle movement

# Example

- Route between the two letters?
- Stage 1: automatic parallel extraction of colors, shapes, position etc.
- Stage 2:
  - Pattern finding of black contours (lines) between two symbols (letters)
- Stage 3:
  - Few objects are held in working memory at a time
  - Identify path sequentially (formulate new visual query)
- In this lecture we will focus on aspects related to stage 1 & 2 of the model

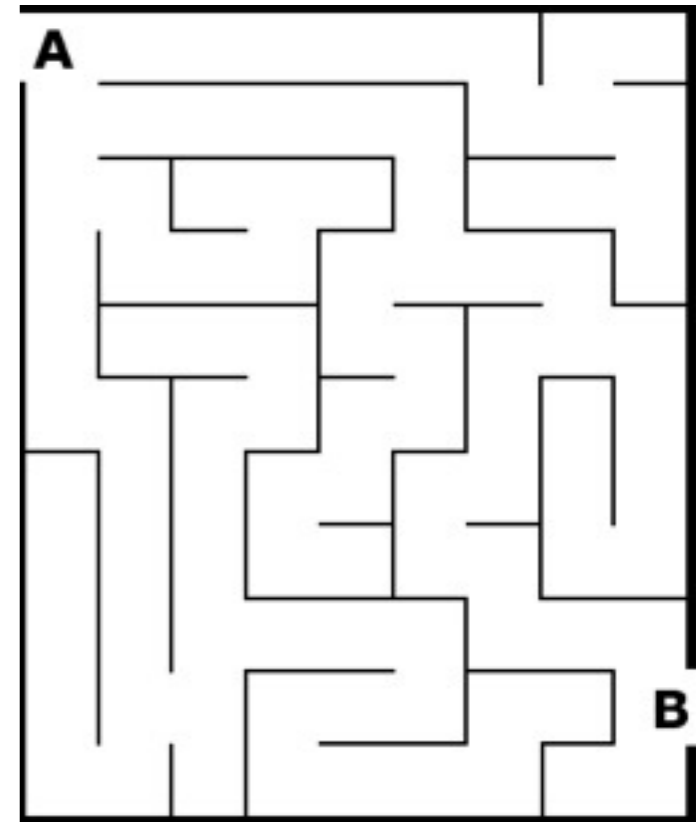

# Outline

- Perception Definition & Context
- Preattentive processing
- Gestalt Laws
- Change Blindness
- Data encoding – glyphs
- Data encoding – color
- Characteristics of Visual Properties



# Preattentive Processing

- A limited set of basic visual properties are processed preattentively
- Information that “pops out”
- Parallel processing by the low-level visual system (Stage 1 in the model)
- Occurs prior to conscious attention
- Important for designing effective visualizations
  - What features can be perceived rapidly?
  - Which properties are good discriminators?
  - What can mislead viewers?
  - How to design information such that it pops out?

# Example: Find the 3s

142416496357598475921765968474891728482  
285958819829450968504850695847612124044  
074674898985171495969124567659608020860  
608365416496457590643980479248576960781  
285960799918712845268101495969124567781  
874241649645757659608149596912456701285  
960799164964575127879918712845298496912  
223591649645759588198250963576596080596

# Example: Find the 3s

142416496**3**57598475921765968474891728482  
285958819829450968504850695847612124044  
074674898985171495969124567659608020860  
608**3**6541649645759064**3**980479248576960781  
285960799918712845268101495969124567781  
874241649645757659608149596912456701285  
960799164964575127879918712845298496912  
22**3**59164964575958819825096**3**576596080596

# Preattentive Processing

- How to find out if a visual attribute is preattentive?
- Measure response time for tasks
  - Detection of a target among distractors – Is the target present?
  - Boundary detection – Do items form two groups?
  - Counting – How many targets are there?
- Detection of targets on a large multi-element display
  - < 200 to 250 ms are considered preattentive
  - Eye movement takes at least 200 ms to initiate
- Example: is there a red target present in the images?

# Color

- Is there a red circle present in the image?

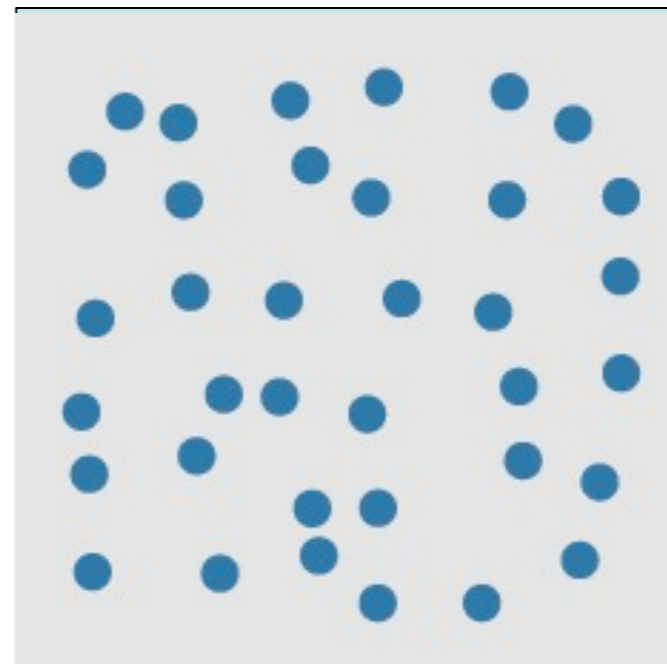
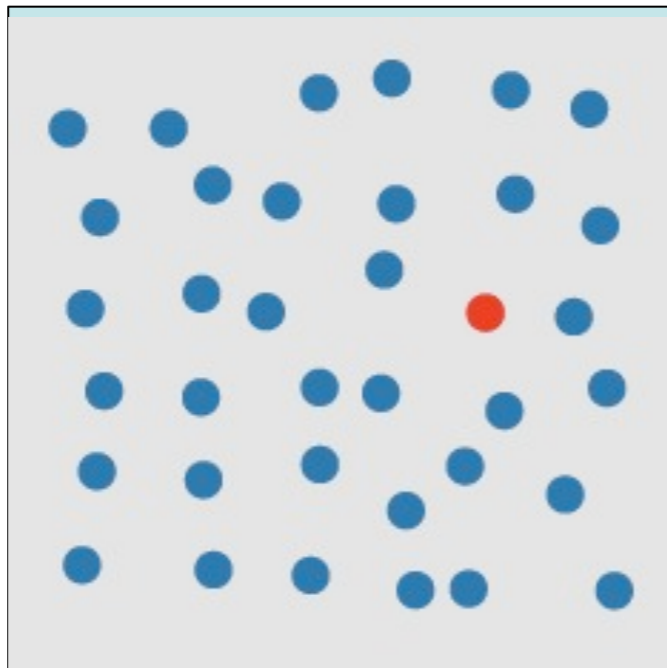

Images taken from <http://www.csc.ncsu.edu/faculty/healey/PP/index.html>

# Color

- Is there a red circle present in the image?

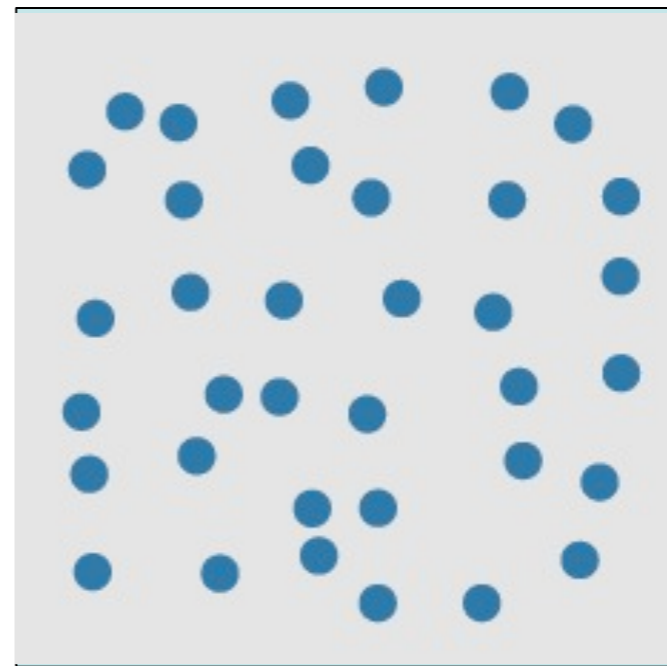
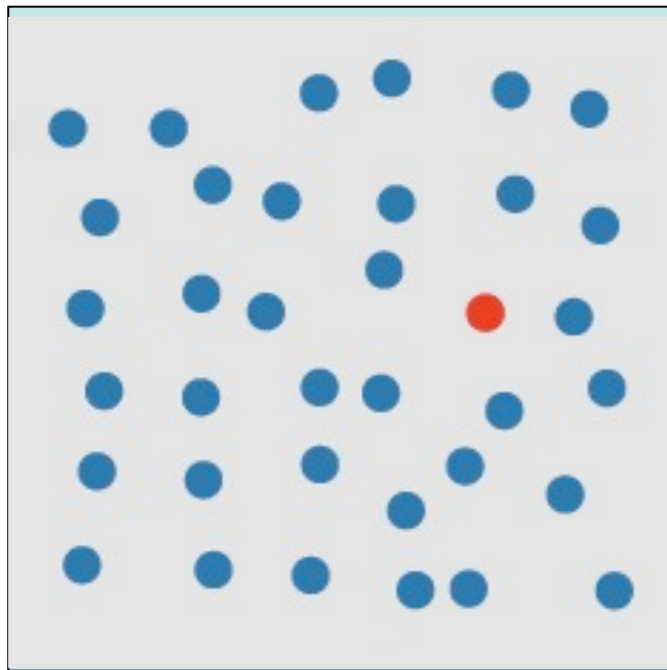

Color is preattentively processed!

Images taken from <http://www.csc.ncsu.edu/faculty/healey/PP/index.html>

# Shape

- Is there a red circle present in the image?

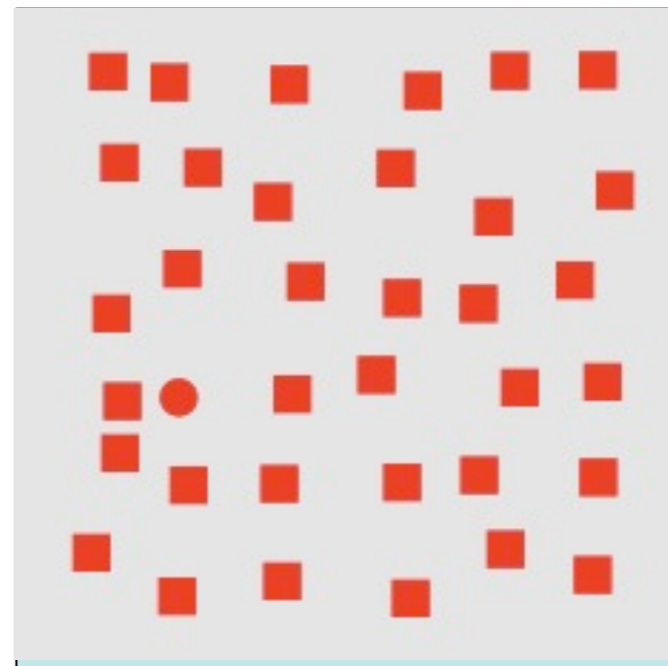
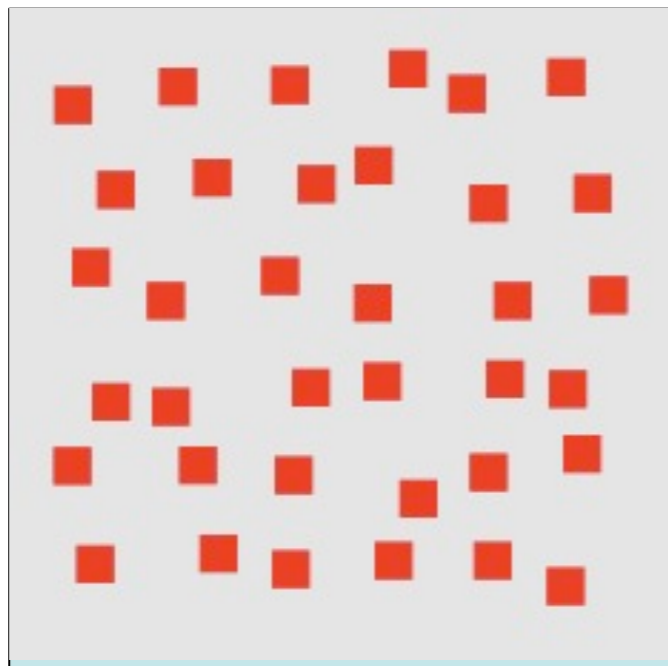

Images taken from <http://www.csc.ncsu.edu/faculty/healey/PP/index.html>

# Shape

- Is there a red circle present in the image?

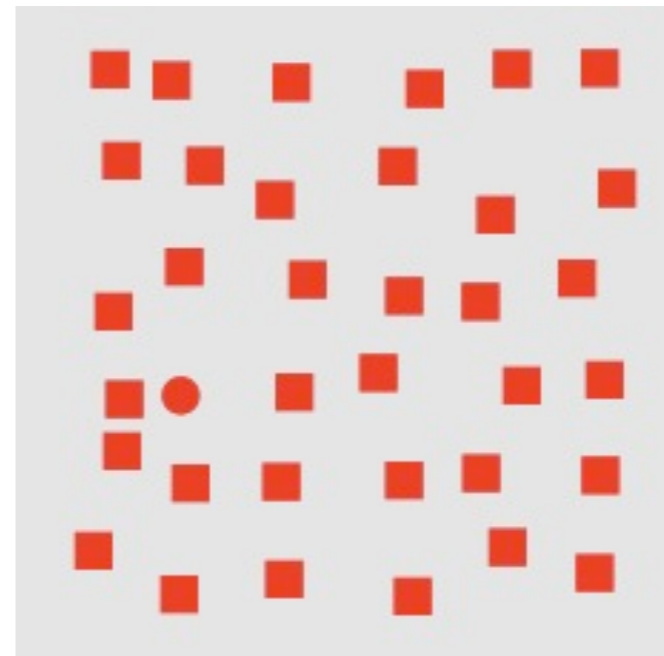
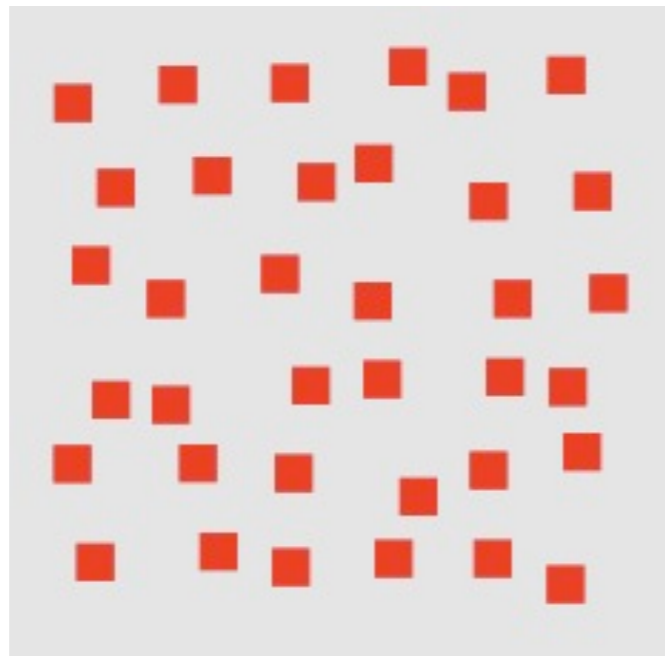

Shape is preattentively processed!

Images taken from <http://www.csc.ncsu.edu/faculty/healey/PP/index.html>



# Color & Shape

- Is there a red circle present in the image?

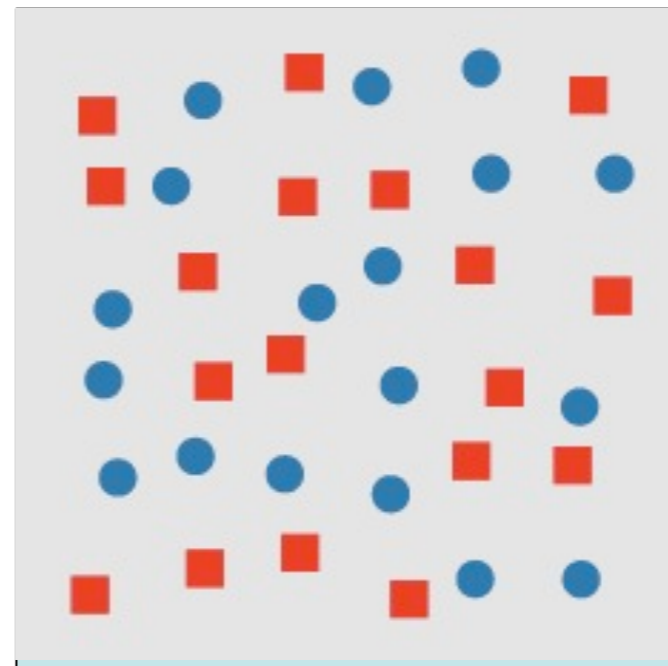
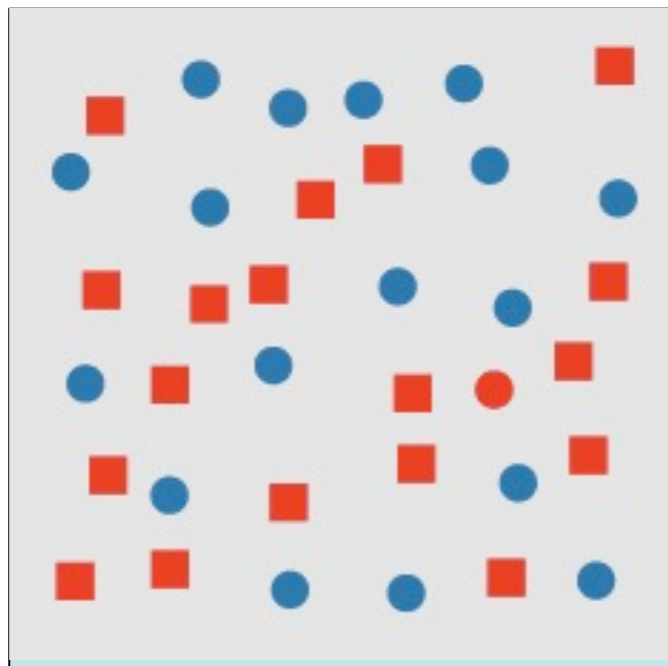

Images taken from <http://www.csc.ncsu.edu/faculty/healey/PP/index.html>

# Color & Shape

- Is there a red circle present in the image?

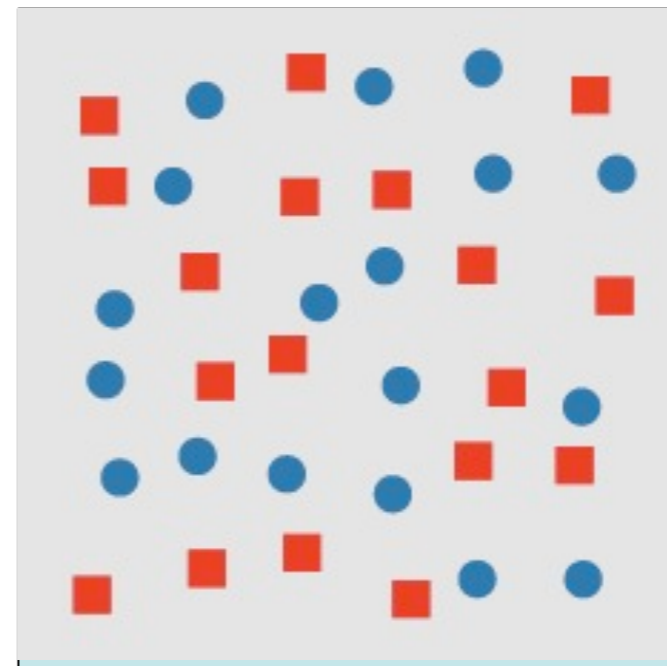
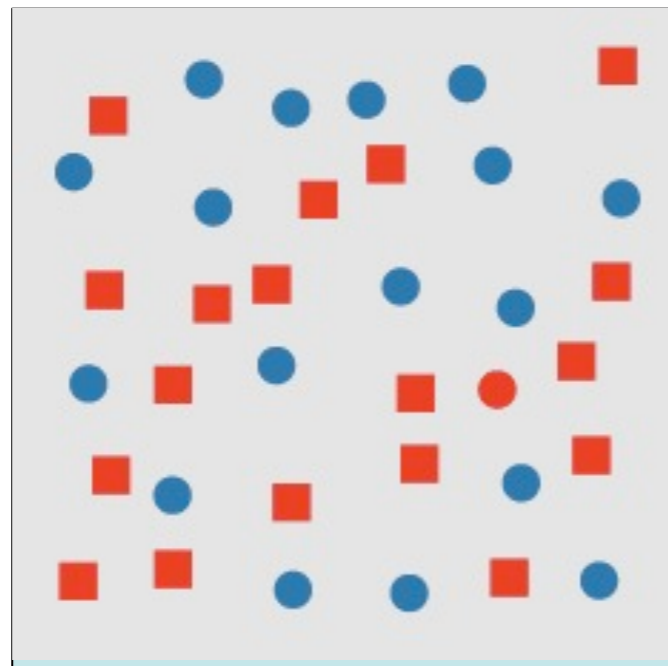

Conjunction of 2 properties is usually not preattentive!

Images taken from <http://www.csc.ncsu.edu/faculty/healey/PP/index.html>

# Boundary Detection

- Do items form a boundary? If yes, based on which attribute(s)?

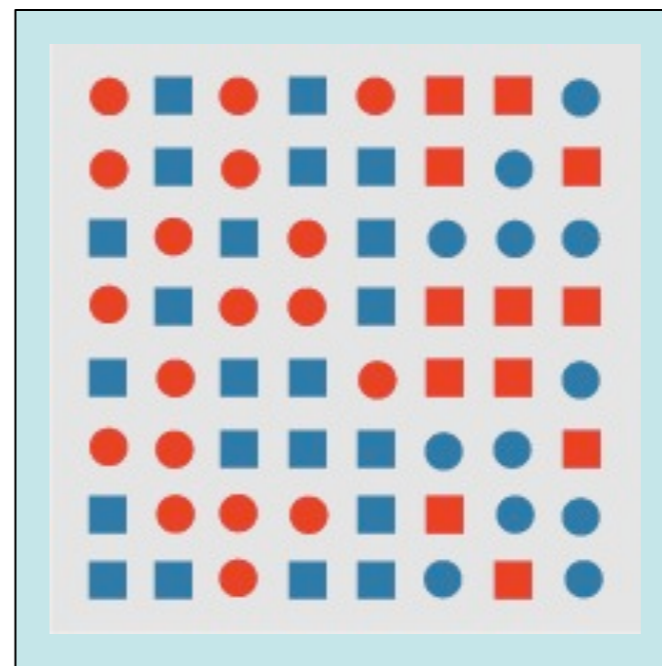
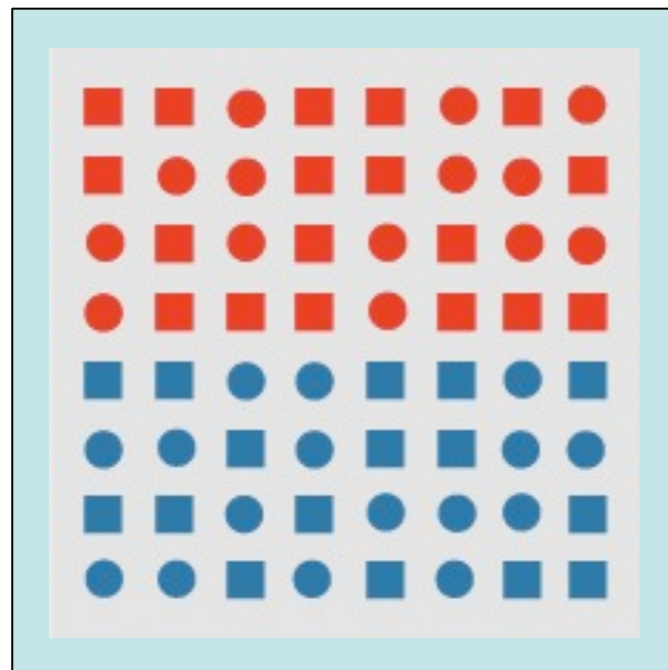

Images taken from <http://www.csc.ncsu.edu/faculty/healey/PP/index.html>

# Boundary Detection

- Do items form a boundary? If yes, based on which attribute(s)?

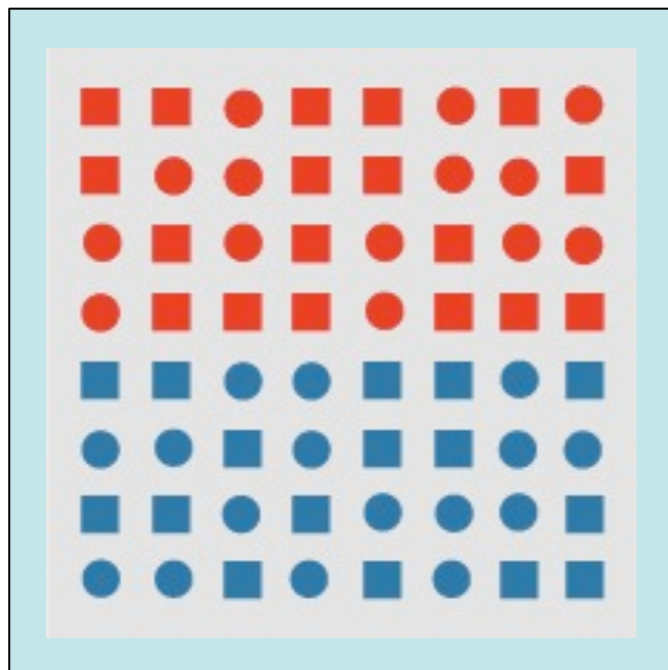

Preattentive: grouping by hue

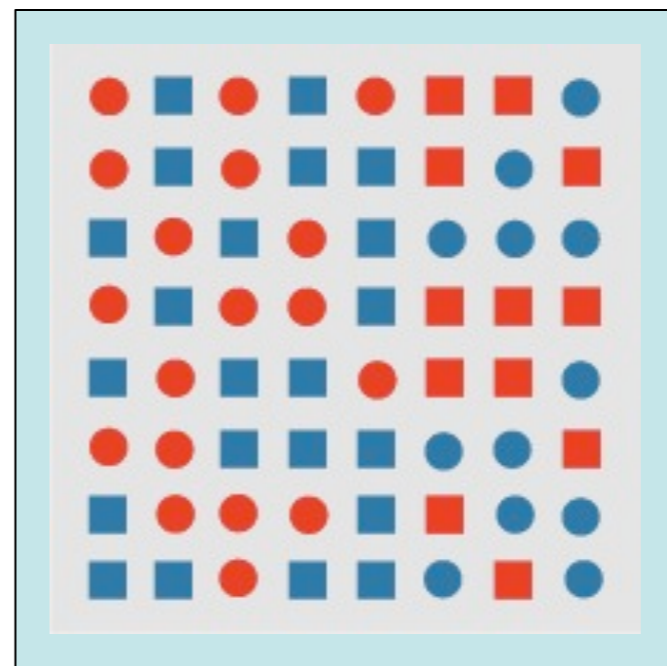

Conjunction search: grouping by hue and shape

Images taken from <http://www.csc.ncsu.edu/faculty/healey/PP/index.html>

# Common Preattentive Properties

- Form

- Line orientation
- Line length
- Line width
- Size
- Curvature
- Shape
- Spatial grouping

- Color

- Hue
- Intensity
- Motion
- Flicker
- Direction of motion
- Spatial Position
- 2D position
- Stereoscopic depth
- Convexity / Concavity

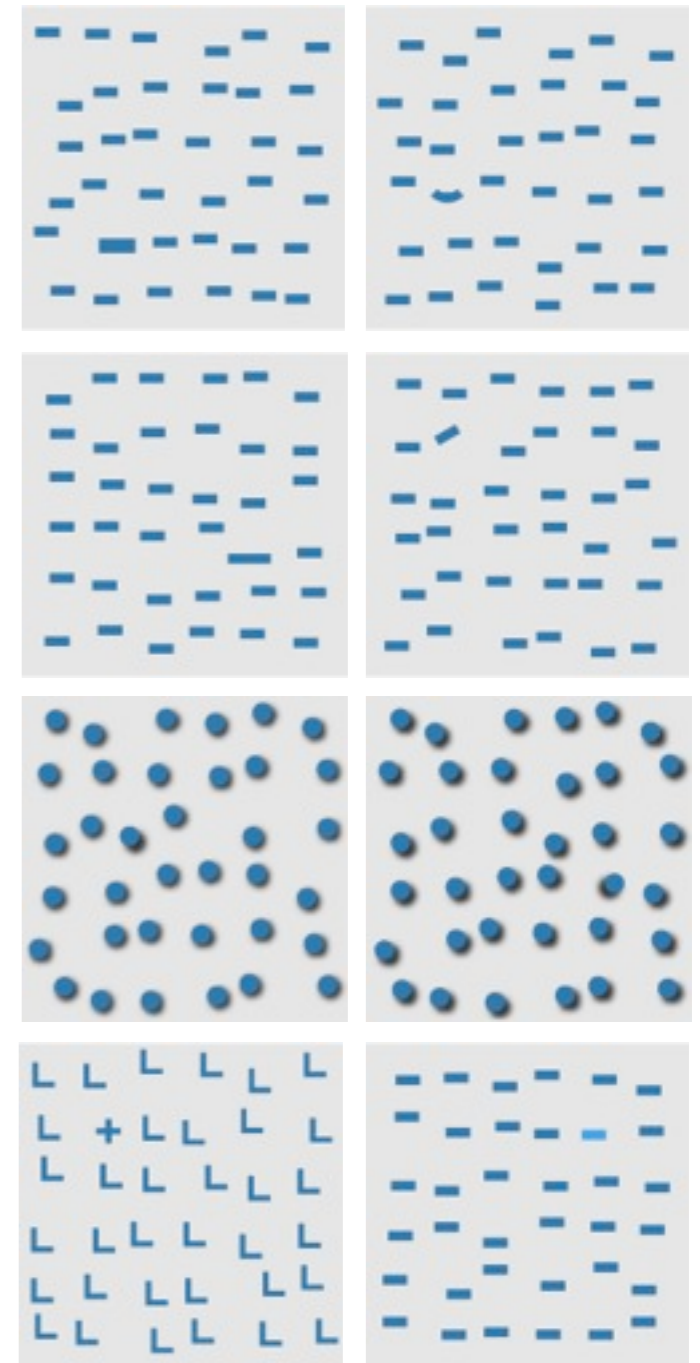

Images taken from <http://www.csc.ncsu.edu/faculty/healey/PP/index.html>



# Conjunction Search

- A target with a **unique** visual property (e.g., shape OR color) “pops out”
- **Conjunction** target is made up of non-unique features
  - Requires a time-consuming serial search, e.g.
    - For every red colored item: is it a circle?
    - For every circular item: is it red?

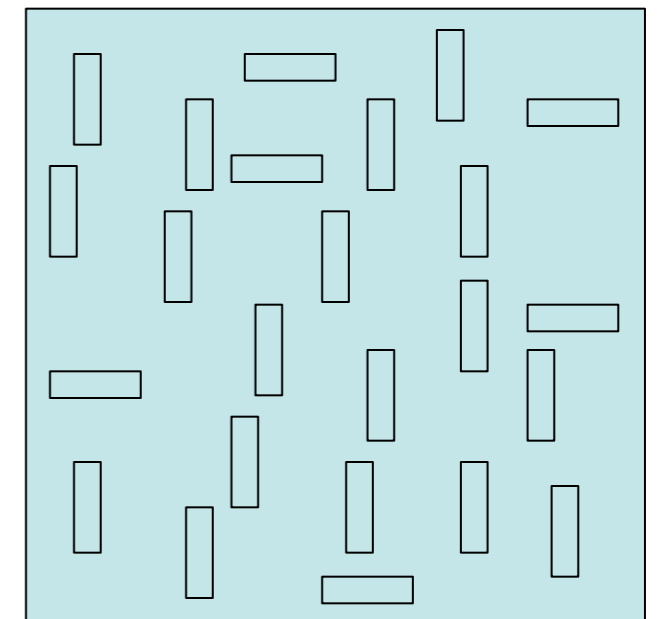
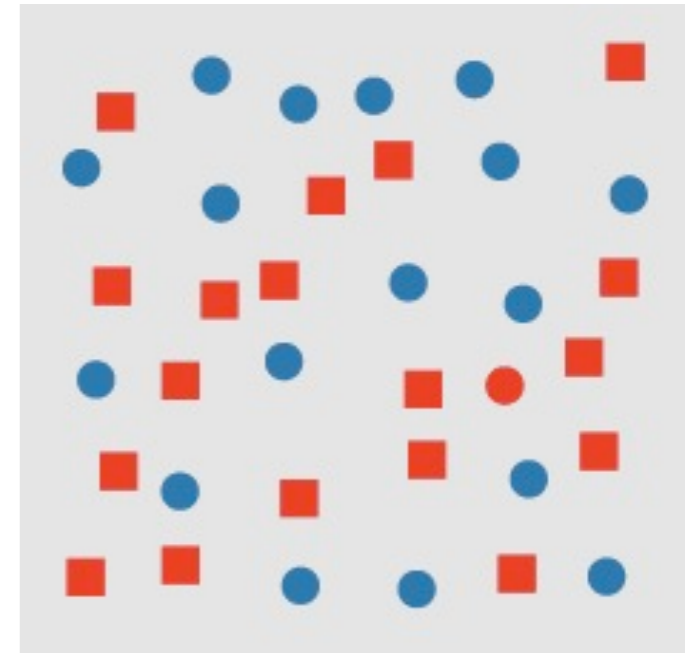

# Outline

- Perception Definition & Context
- Preattentive processing
- Gestalt Laws
- Change Blindness
- Data encoding – glyphs
- Data encoding – color
- Characteristics of Visual Properties

# Cognition and Gestalt Laws

- See „Digitale Medien“, Chapter 3a (typography)
- Recap: step 2 of the visual information processing model – pattern and object recognition using the raw data collected in step 1
- Based on which visual properties do we structure the data?
- Gestalt school of psychology founded in 1912 formulated Gestalt laws
- “The whole is greater than the sum of parts” (Koffka 1935)
- Laws still useful today, but not the neural mechanisms proposed
- Perception: An introduction to the Gestalt-theorie (Kurt Koffka, 1922): <http://psychclassics.yorku.ca/Koffka/Perception/perception.htm>



# Example of Gestalt perception



# What do you see?

- Can you find the dog?
- Dalmatian exploring a leaf covered forest floor
- Once you have found it, try to think of the picture as a simple pattern of black and white again
- Does it work?
- Mind tries to detect anything meaningful by identifying patterns
- Different tools are tried sequentially
- Perceptual organization is a powerful mechanism

# GL: Grouping by Spatial Proximity

- Columns or rows?
- Small difference in spacing causes change in perception
- Use proximity to emphasize between display items
- To which group (top / bottom) does the x dot belong?  
Spacing is equal for both groups!
- Spatial concentration principle: we group regions of similar element density (Slocum1983)

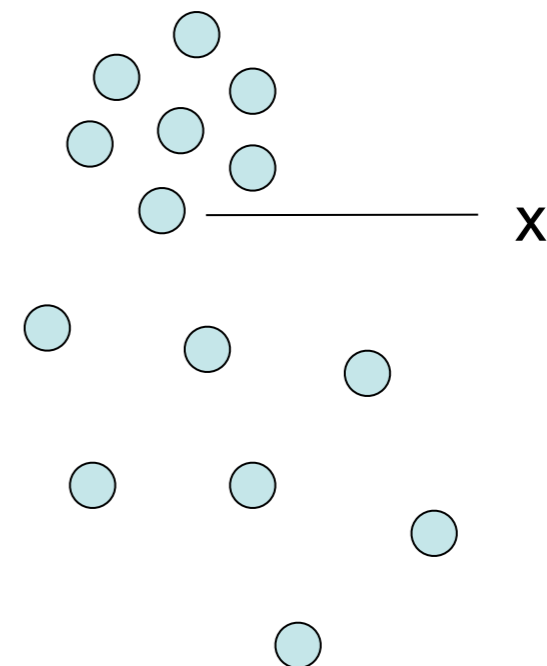
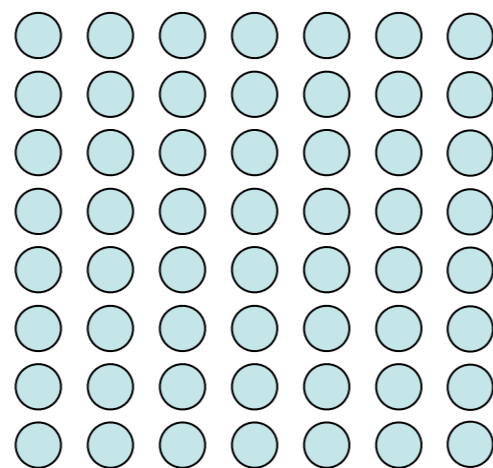
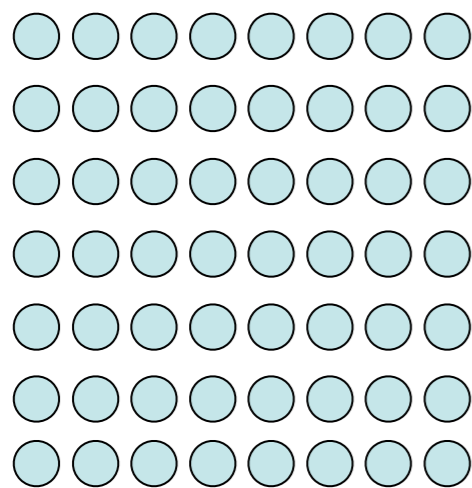

# GL: Similarity

- Rows or columns?
- Similar elements tend to be grouped together

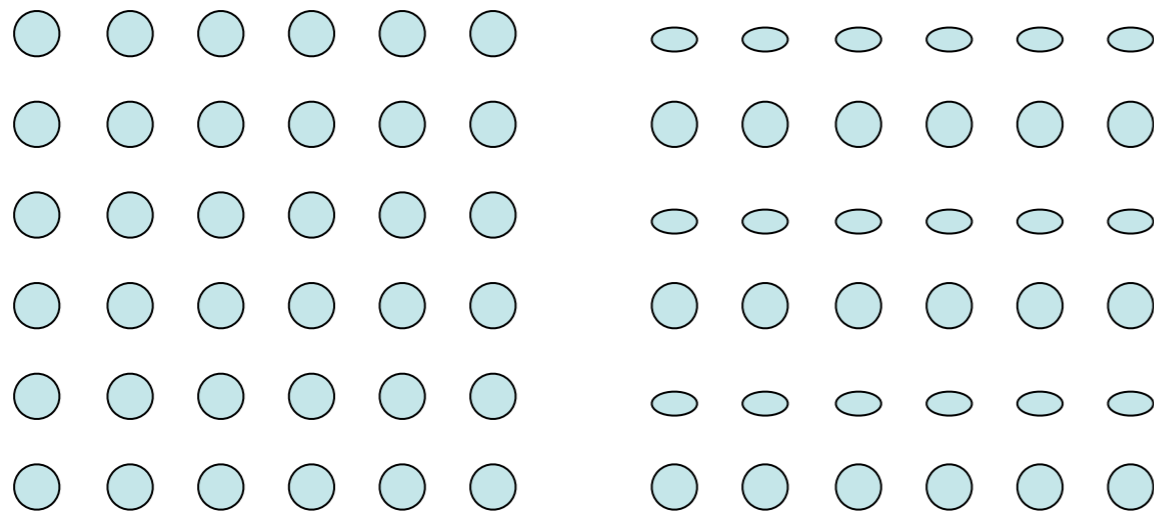

# GL: Connectedness

- Palmer & Rock 1994
- Potentially more powerful organizing principle than proximity, color, size, shape

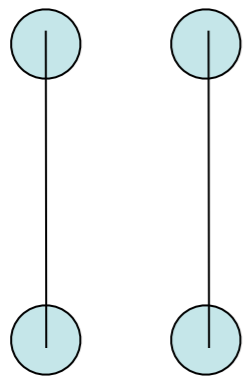

proximity

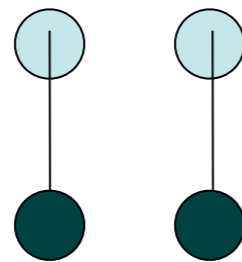

color

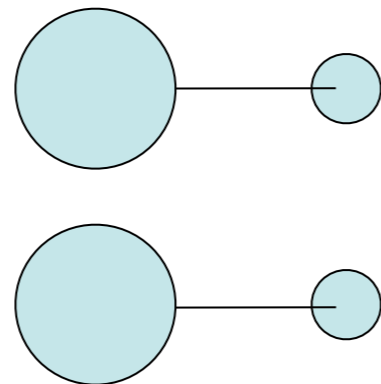

size

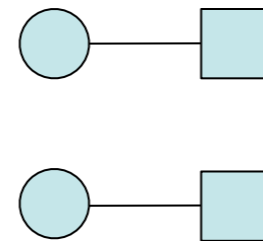

shape



Example: node-link diagram

# GL: Continuity

- Example circuit design – understanding how components are connected

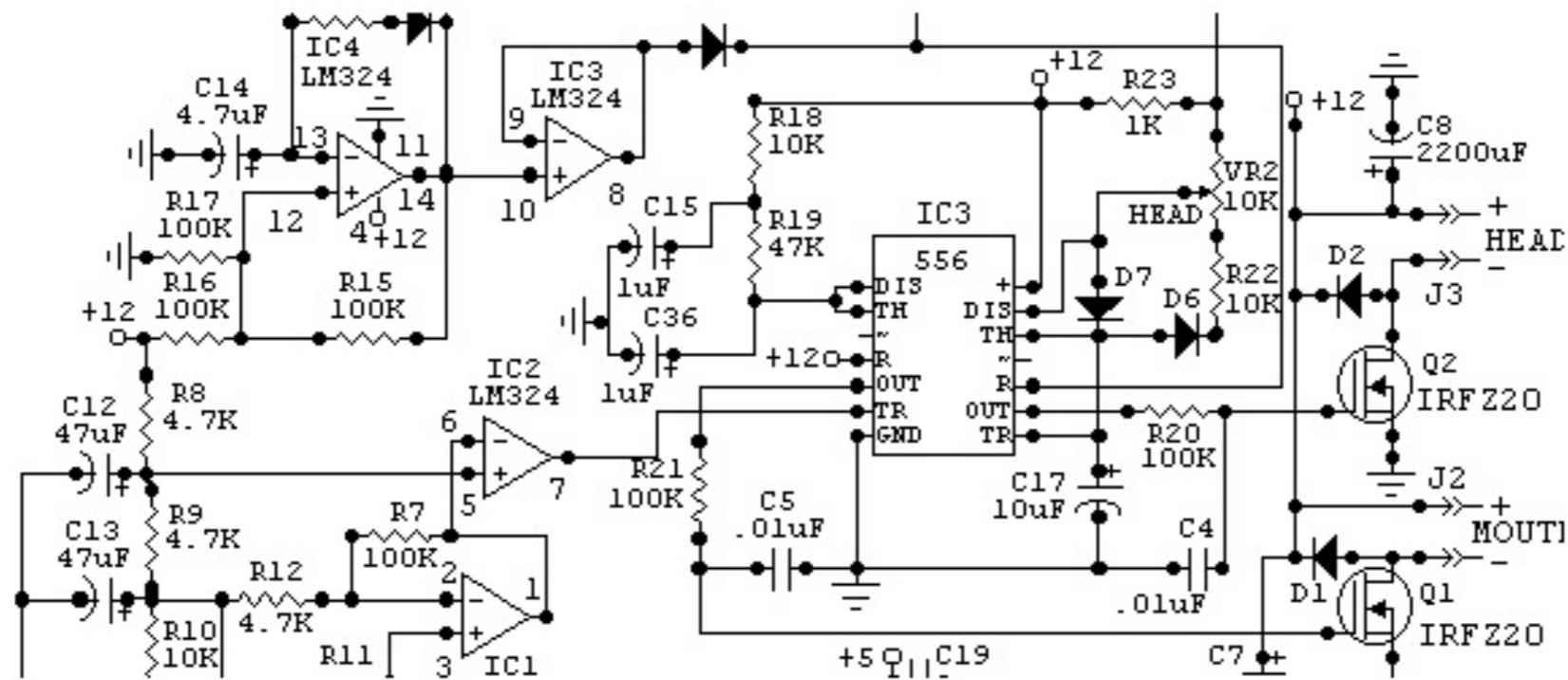

# GL: Symmetry

- Example of how symmetry detection may be exploited for visual data mining
- Support the search for similar patterns in time-series plots (measurements of deep ocean drilling cores)

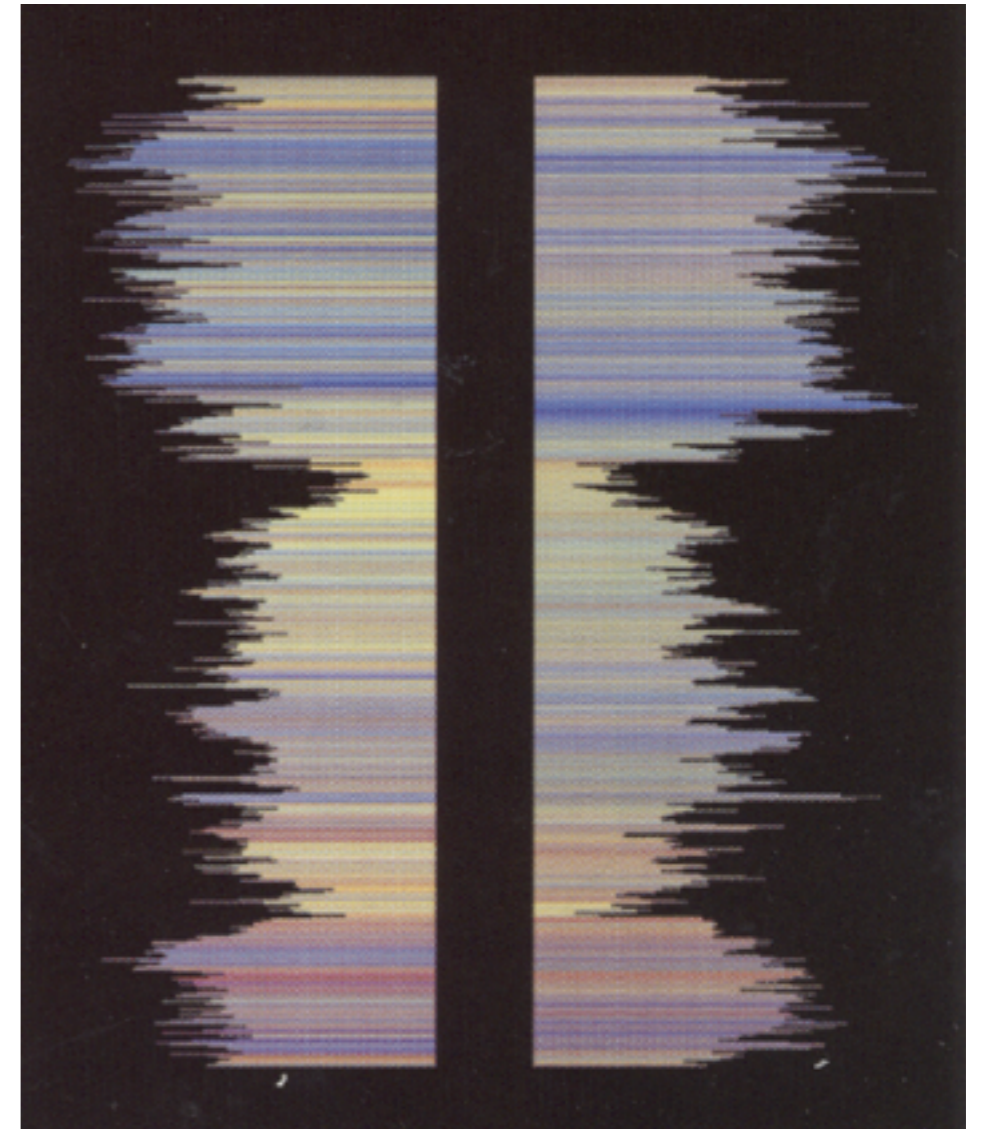
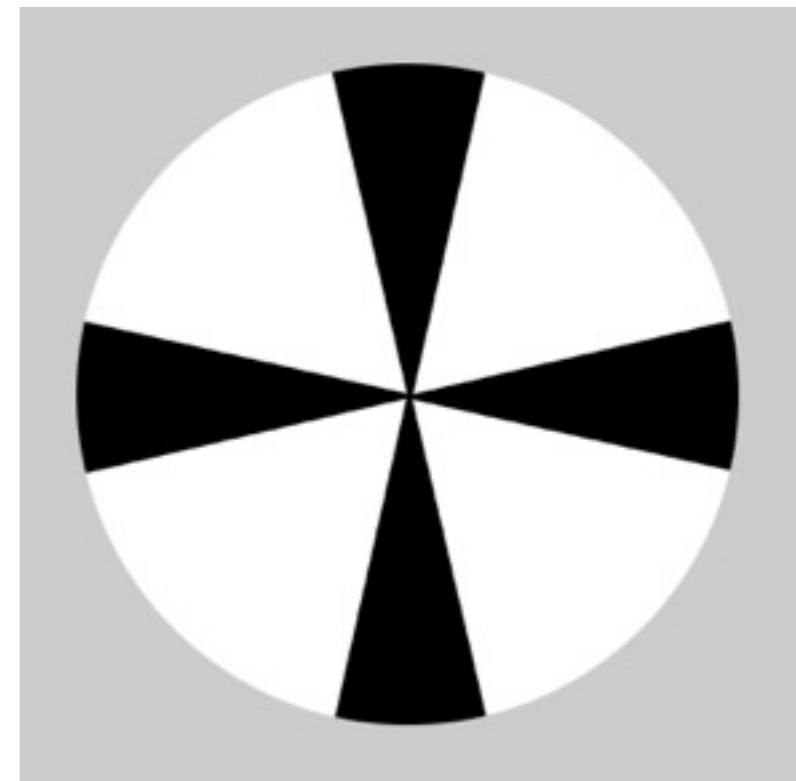
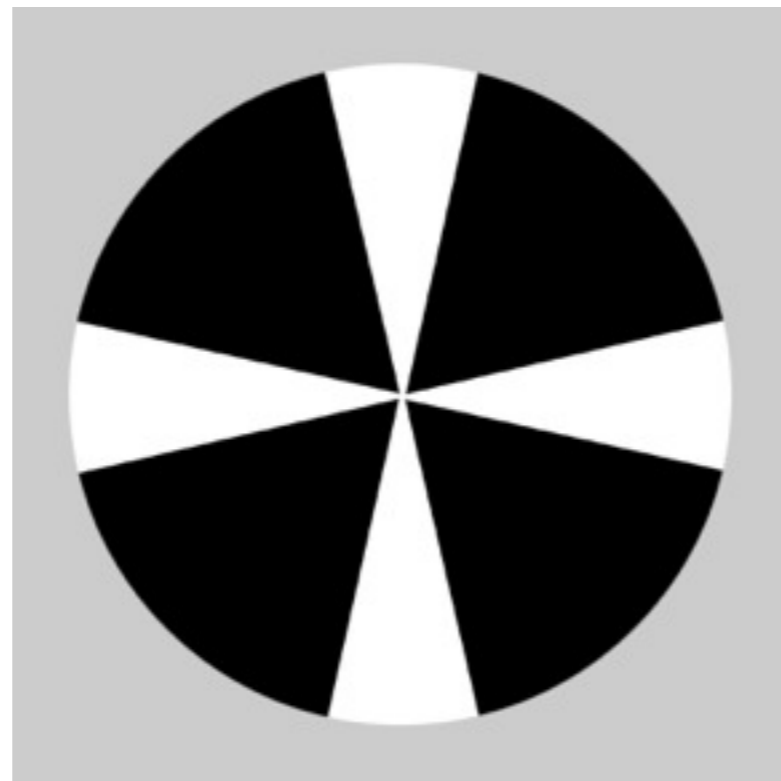

Image taken from Ware 2001



# GL: Area

- Smaller components of a pattern tend to be perceived as an object
- White propeller and black propeller





# GL: Figure & Ground

- Figure: something object-like that is perceived being in the foreground
- Ground: whatever lies behind the figure
- Fundamental perceptual act of identifying objects
- All Gestalt laws contribute, e.g., closed contour, symmetry, area
- Equally balanced cues for figure and ground can result in bistable perception

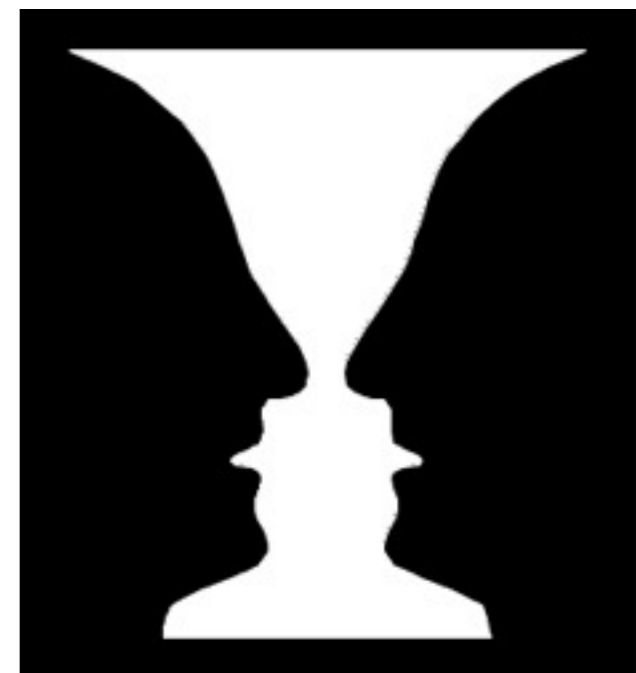

# GL: Common Fate

- Objects moving in the same direction are perceived as an entity
- Example taken from: <http://tepservers.ucsd.edu/~jlevin/gp/time-example-common-fate/>

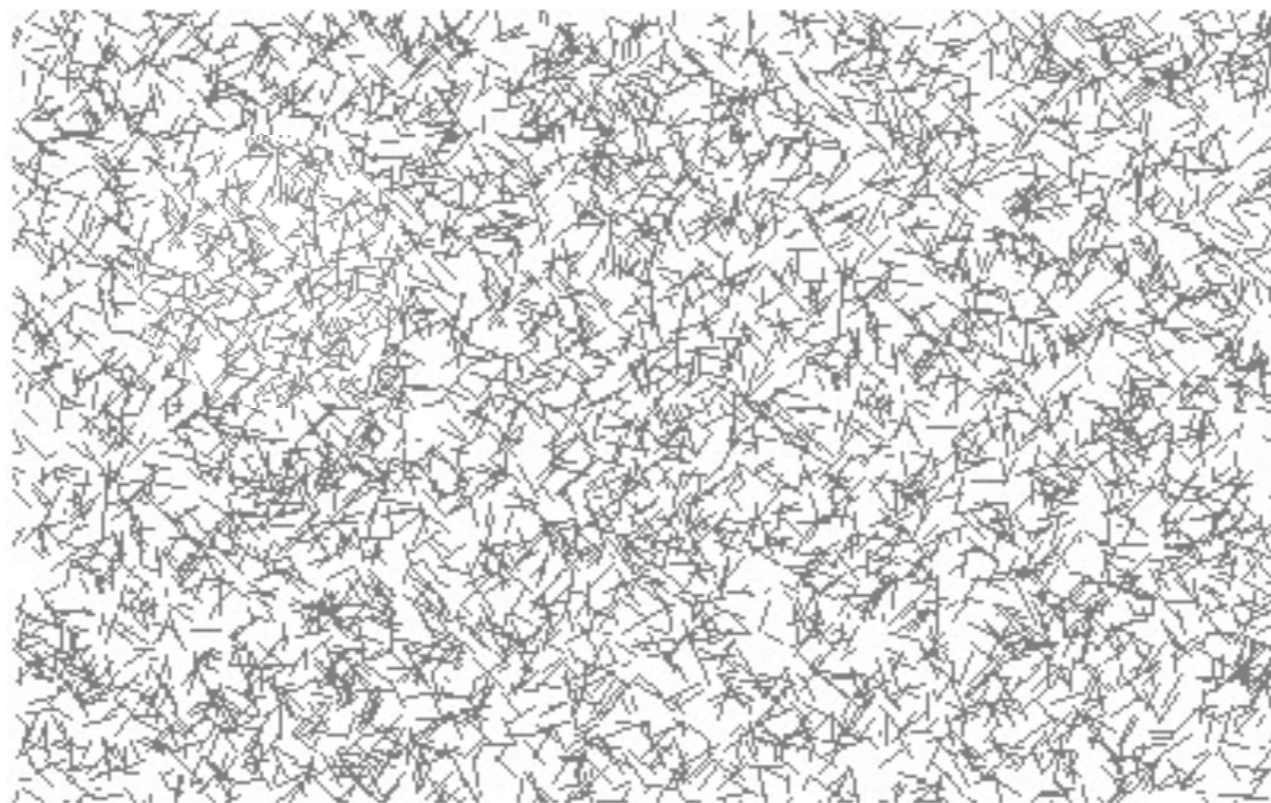

# Outline

- Perception Definition & Context
- Preattentive processing
- Gestalt Laws
- Change + Inattentional Blindness
- Data encoding – glyphs
- Data encoding – color
- Characteristics of Visual Properties

# Change Blindness (CB)

- Example: old style aircraft altimeter
  - Thinnest hand indicates number of tens of thousands of feet
  - Next larger hand number of thousands of feet
  - Quick glance after interruption results in misinterpretation if the change in the display is not noticed
  - Difference of ten thousand feet
- Phenomenon: inability to detect changes in visual scenes
  - mid-eye movement
  - mid-blink
  - Flicker (short blanking of screen)
  - Gradual change



# Change Blindness (CB)

- Participants of a study were found unable to detect a change from one person to another in midconversation (Simson & Levin 1998)
- Sample principle: insensitivity to changes of objects in movie scenes interrupted by a cut (Levin & Simons 1997)
- Various examples: [http://viscog.beckman.uiuc.edu/djs\\_lab/demos.html](http://viscog.beckman.uiuc.edu/djs_lab/demos.html)
- Problem related to the short-lived visual buffer and the very limited capacity of our visual working memory
- Need to emphasize changes
- In some applications changes may be distracting, e.g. ambient information visualization -> utilize CB



# CB: Flicker Example 1



<http://www.csc.ncsu.edu/faculty/healey/PP/index.html>



# CB: Flickr Example 2



<http://www.csc.ncsu.edu/faculty/healey/PP/index.html>



# CB: Gradual Change Example





# Recognition is primed by expectation

- <http://www.youtube.com/watch?v=kjtSfTCrMm4&feature=related>



# Inattentional Blindness

- Basketball passes: <http://www.youtube.com/watch?v=Ahg6qcgoay4&feature=fvw>
- Color changing card trick: [http://www.youtube.com/watch?v=hDLLf\\_WCyZ4&hl=de](http://www.youtube.com/watch?v=hDLLf_WCyZ4&hl=de)

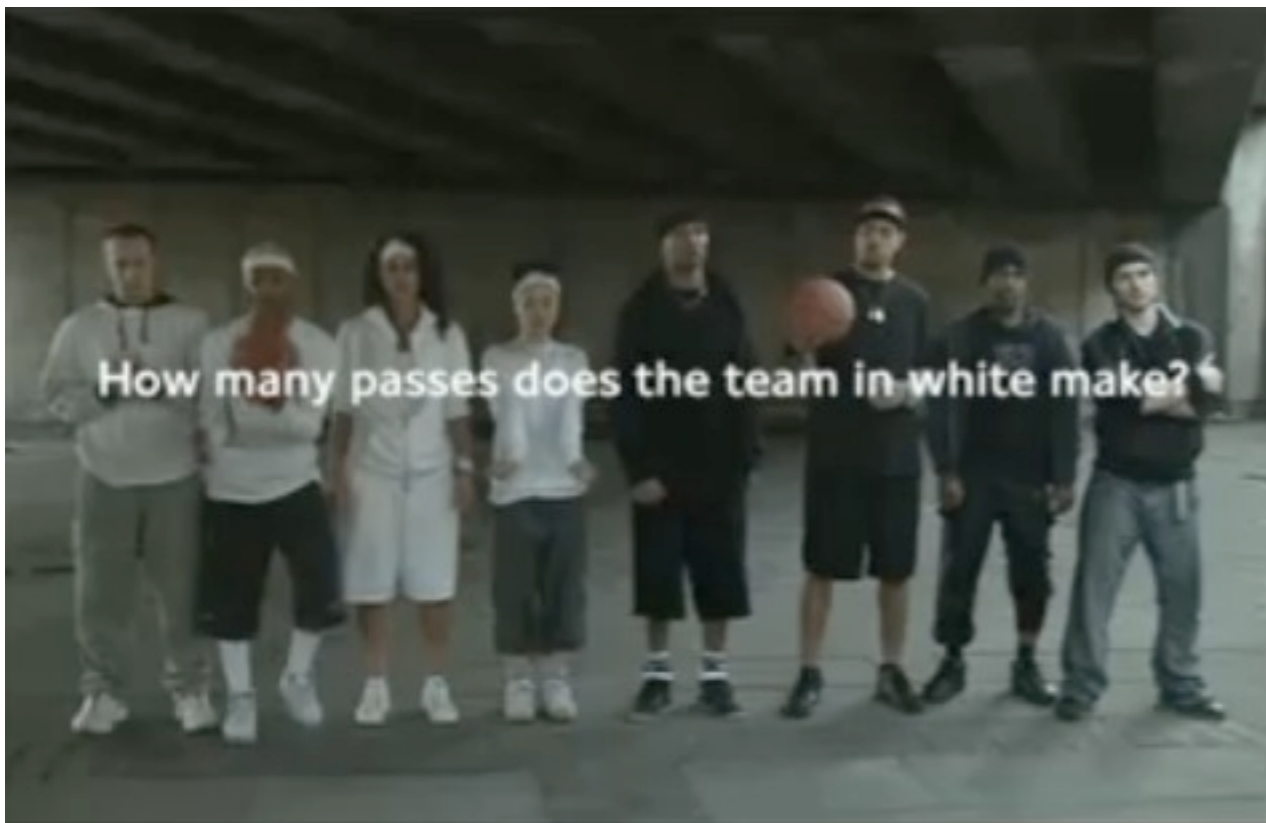

# Perception Summary

- It is not enough to simply show something.
- We need to pay attention when and how it is shown.
- Otherwise people might miss it or take forever to find it.
- Apply your knowledge about perception to check whether your visualizations are effective!

# Outline

- Perception Definition & Context
- Preattentive processing
- Gestalt Laws
- Change Blindness
- Data encoding – glyphs
- Data encoding – color
- Characteristics of Visual Properties

# Encoding Data with Glyphs

- Glyph: graphical object designed to convey multiple data values
- Multidimensional discrete data, e.g. a collection of cars with several attributes each, e.g. horsepower, weight, acceleration etc.
- What visual properties can be mapped to the attributes?
- FilmFinder example
  - Color to film genre
  - X-position to year of release
  - Y-position to popularity
- Additional properties
  - Lightness
  - Shape
  - Orientation
  - Texture
  - Motion
  - Blinking

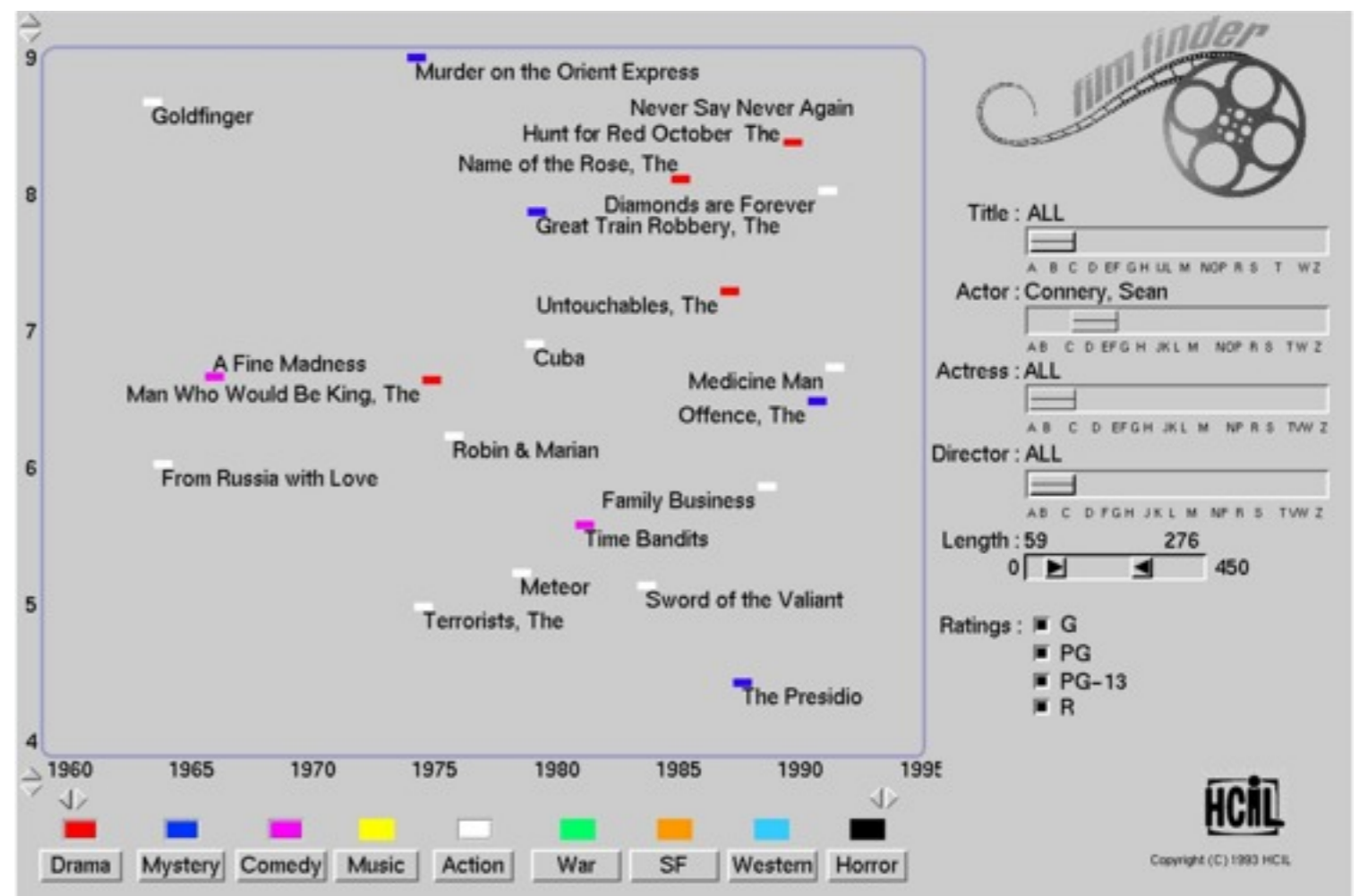

FilmFinder ([www.cs.umd.edu/](http://www.cs.umd.edu/))

# Encoding Data with Glyphs

- Limitations of low-level graphical attributes for glyph design
- Easily resolvable steps of a visual property
  - 12 colors (for preattentive processing only 8 colors)
  - About 4 orientation steps
  - At most 4 size steps
  - Binary blink coding (on / off)
  - Texture unknown
  - Shape unknown
- Mixing visual properties
  - Properties are not independent from each other, e.g. blink coding interferes with motion coding
  - Conjunctions are usually non-preattentive
  - Some dimensions are integral
  - Best to restrict the mapping to color, shape, spatial position (and motion)

# Outline

- Perception Definition & Context
- Preattentive processing
- Gestalt Laws
- Change Blindness
- Data encoding – glyphs
- Data encoding – color
- Characteristics of Visual Properties



# Color Vision & Model

- Human color vision
  - Sensory response to electromagnetic radiation in the spectrum 0.4 – 0.7 micrometers
  - Based on three dimensions (three different types of color receptors in human retina)
- Powerful encoding potential: compared to gray scales the number of just noticeable differences is much higher
- About 8% of the male and 1% of the female population are color-blind
- Color Model HSV (aka HSB)
  - Hue - blue, green, etc. (X axis)
  - Saturation – intensity of color (Y axis)
  - Value – light/dark (slider)

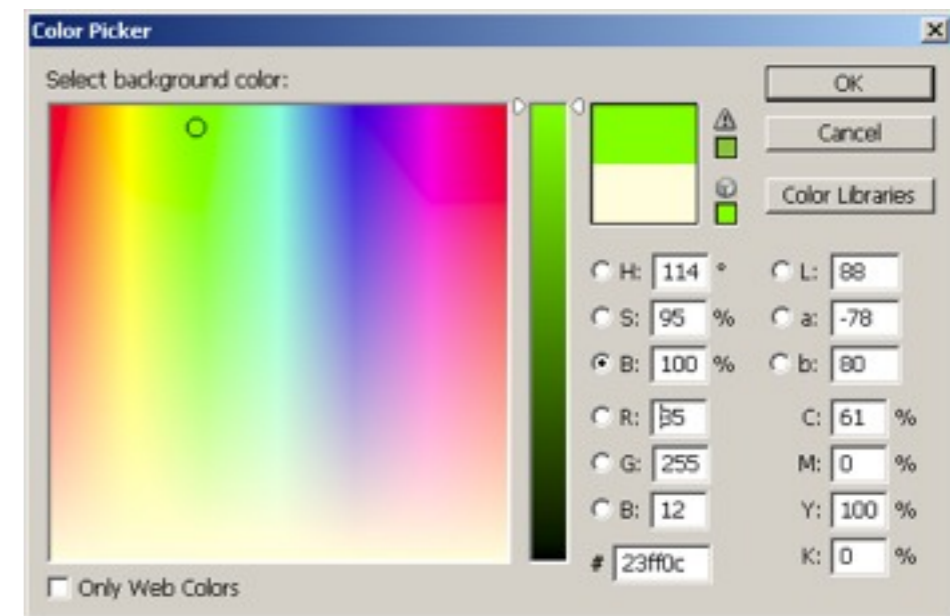

HSV 2D color picker

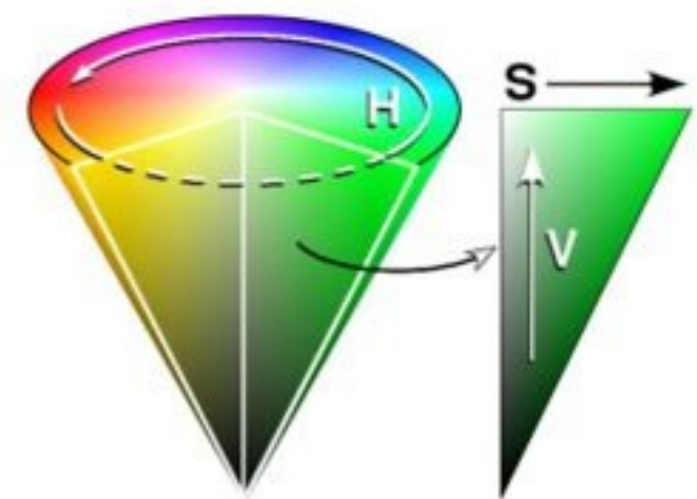

HSV cone representation



# Color Scales

- Definition: pictorial representation of a set of distinct categorical or numerical values, where each value is assigned its own color (Levkovitz 1996)
- Desired properties of perception
  - Preserve the order of the data values, if any
  - Uniform distance between adjacent values (i.e. equally spaced numerical steps are perceived as equally spaced perceptual steps)
  - No artificial boundaries that do not exist in the data (i.e. continuously present continuous values)

# Color Rules I

- Always ensure a reasonable luminance contrast between foreground and background color – chromatic variation may not be enough!
- Black and white borders around colored symbols can reduce contrast effects
- Canonical colors (close to an ideal) are easier to remember
- Only a small set of basic colors should be used for nominal (distinct) labeling
  - At most 12 colors: red, green, yellow, blue, black, white, pink, cyan, gray, orange, brown, purple
  - The first four colors are “hard-wired” into the human brain – should be used with priority

# Grayscale

- Usually not considered a color scale, but very common
- Provides simple and natural sense of order
- Disadvantages
  - Limited number of just-noticeable-differences (JNDs) about 60 to 90
  - Contrast effects can significantly reduce accuracy
  - Luminance channel is fundamental to much of perception – grayscale encoding may be considered “a waste of perceptual resources” (Ware, 2000)

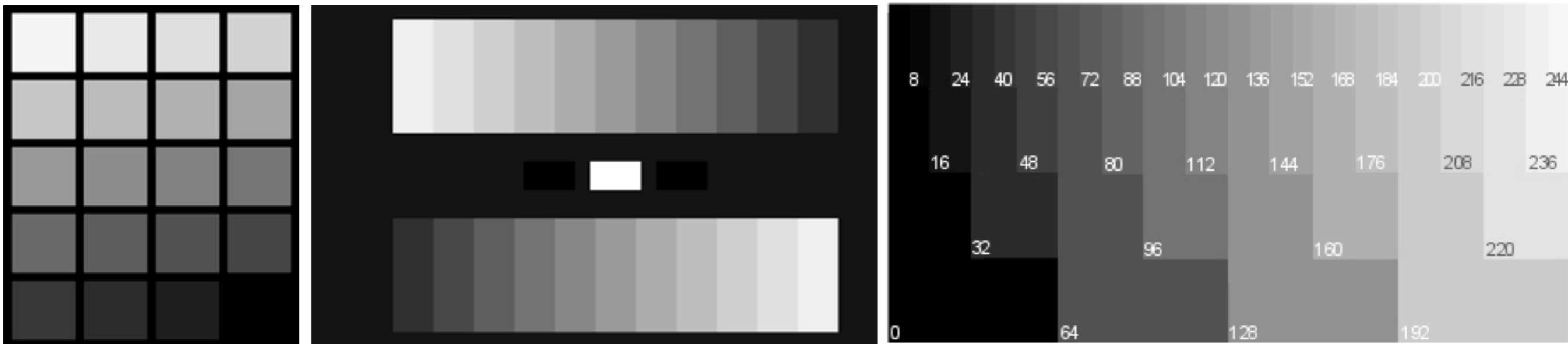

# Rainbow for Ordering Data?

- Most common: rainbow scale for ordinal and quantitative (spectral colors)
  - Continuous spectrum 
  - Common arbitrary division in 8 or less named colors (red, orange, yellow, green, cyan, blue, indigo, violet)
- Problems with rainbow scale
  - Can you order the color blocks from low to high?
  - Yellow (in the middle of the scale) may draw too much attention, when users are seeking for extreme values
  - Perception of non-existing boundaries

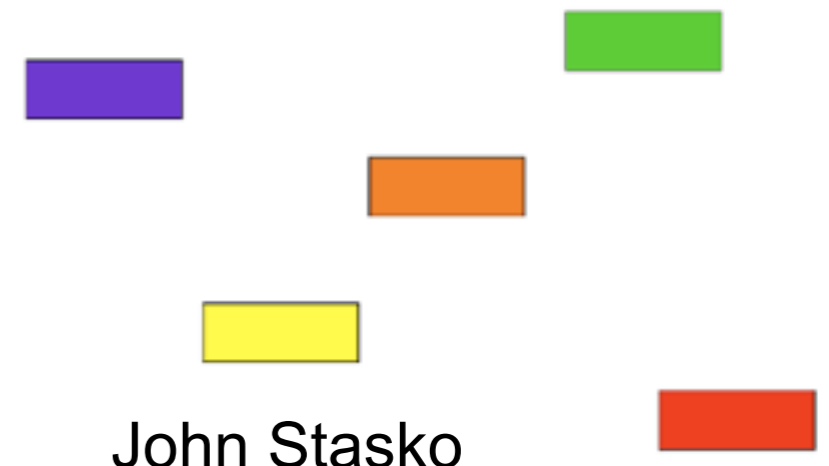

# Recommended Color Scales

- Ordinal data
  - Low saturation to high saturation (single hue) - also very limited JNDs
  - Dark to light (single hue)
  - Red to green, yellow to blue, red to blue
- Ratio (hardly feasible) / diverging data
  - Neutral value (e.g. white) to represent zero
  - Increases in saturation toward distinct colors for positive and negative values (double-ended multiple hue)
- Look up [www.colorbrewer2.org](http://www.colorbrewer2.org) for inspiration



# colorbrewer2.org

number of data classes on your map  
3 [learn more >](#)

the nature of your data  
sequential [learn more >](#)

pick a color scheme: BuGn



multihue      single hue



(optional) only show schemes that are:

colorblind safe     print friendly  
 photocopy-able    [learn more >](#)

pick a color system

229, 245, 249     RGB    CMYK    HEX  
153, 216, 201  
44, 162, 95

adjust map context

roads      
 cities      
 borders    

select a background

solid color      
 terrain

color transparency

[learn more >](#)

how to use | updates | credits

**COLORBREWER 2.0**  
color advice for cartography

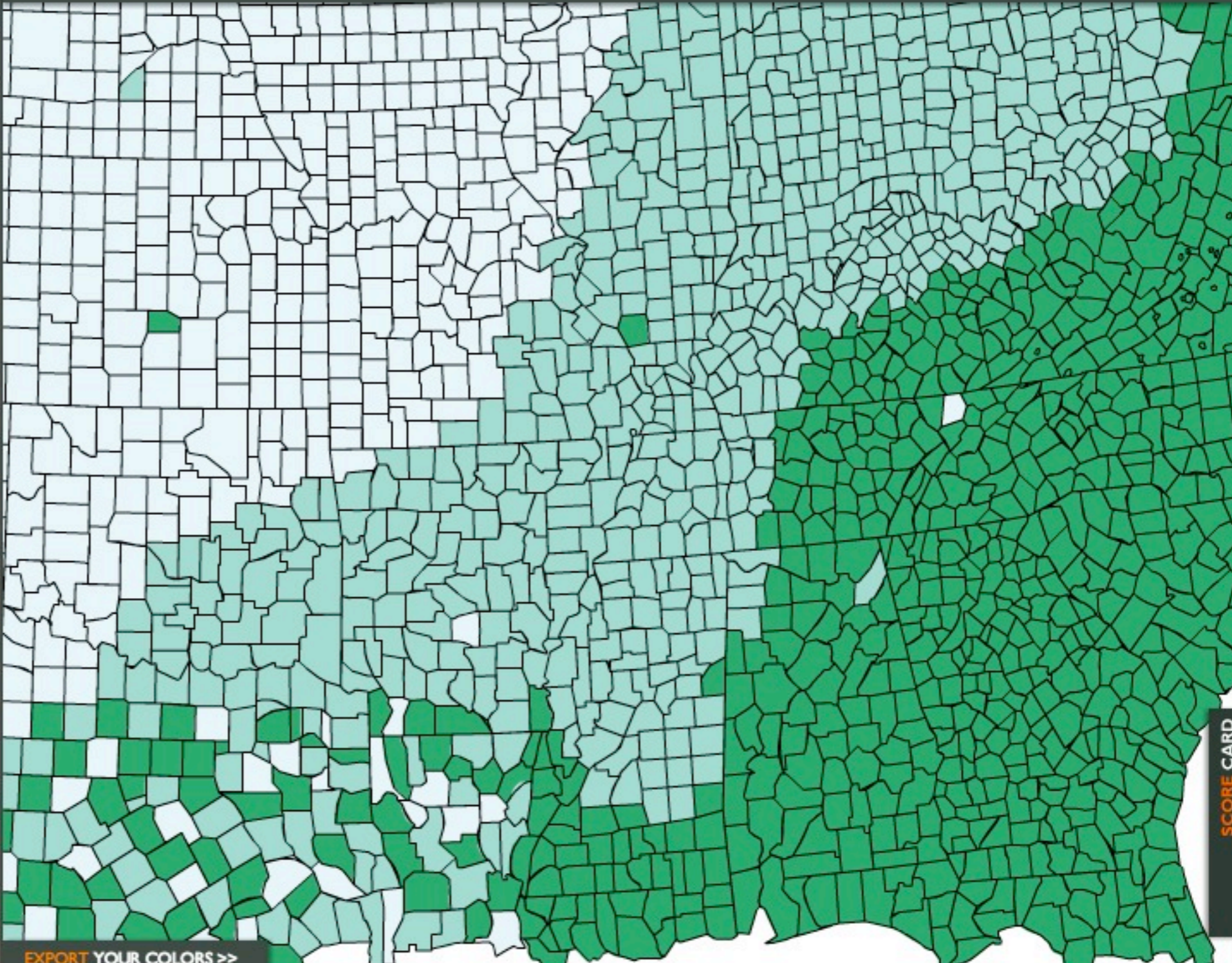

EXPORT YOUR COLORS >>

SCORE CARD



# Redundant Color Scales

- Use multiple color properties to redundantly represent data
- Visual reinforcement of steps
- Overcome visual deficiencies
- Redundant model components: data values are mapped to both hue and brightness
- Heated-object scale
  - Going from black to white passing through orange and yellow
  - Monotonic increase in brightness provides more natural ordering than rainbow scale
- Linearized optimal color scale
  - Scale maximizing the number of JNDs while preserving a (more or less) natural order

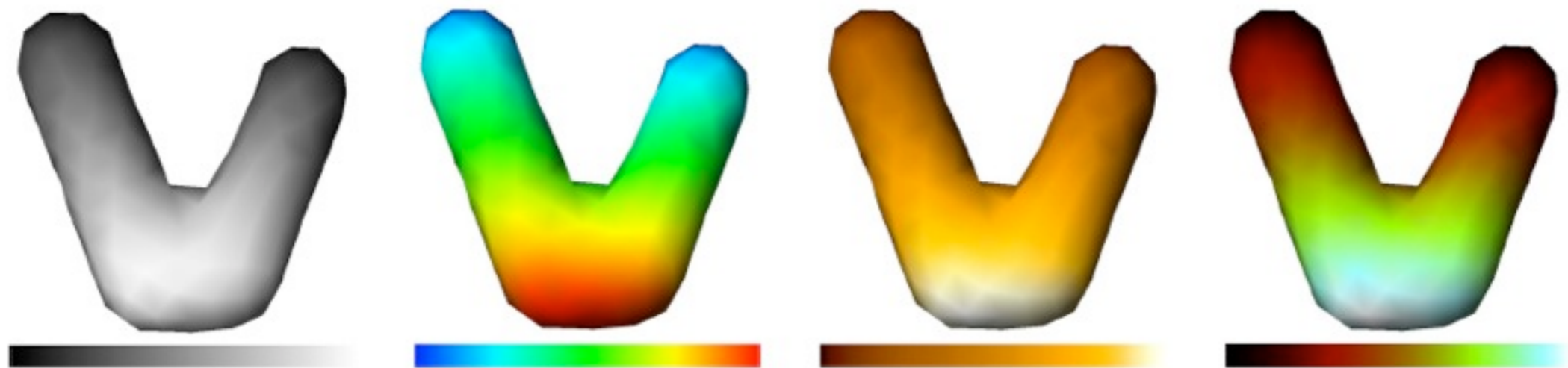

Silva et al. 2007

# Color Scale

- US presidential elections - Bush & RNC's campaign funding



<http://fundrace.huffingtonpost.com/moneymap.php?cand=Bush&zoom=County>



# Color Scale

- Vote distribution of 2004 US presidential election - the darker the color, the more of a landslide it was for the winning party

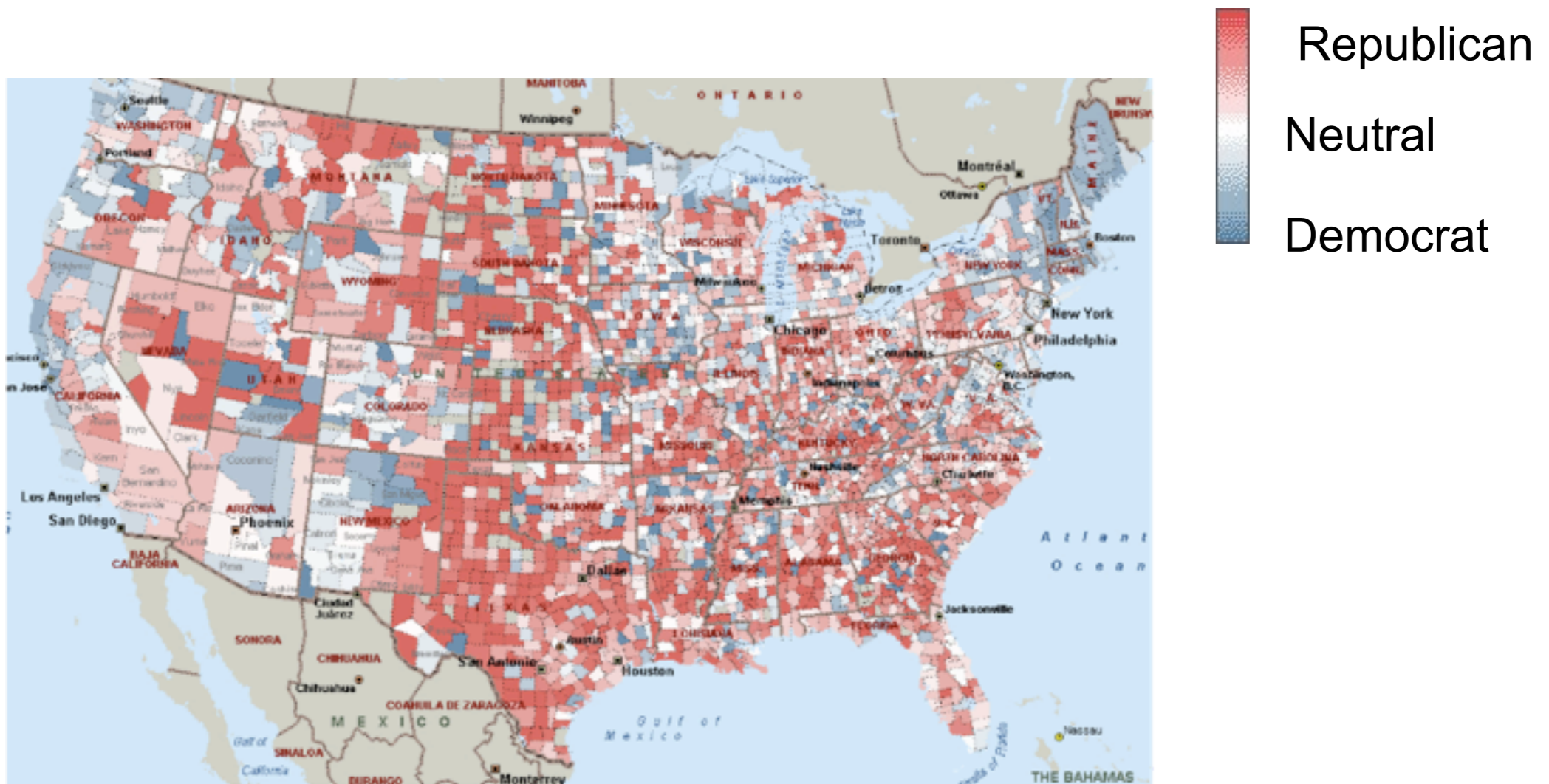

<http://fundrace.huffingtonpost.com/moneymap.php>

# Color Scale

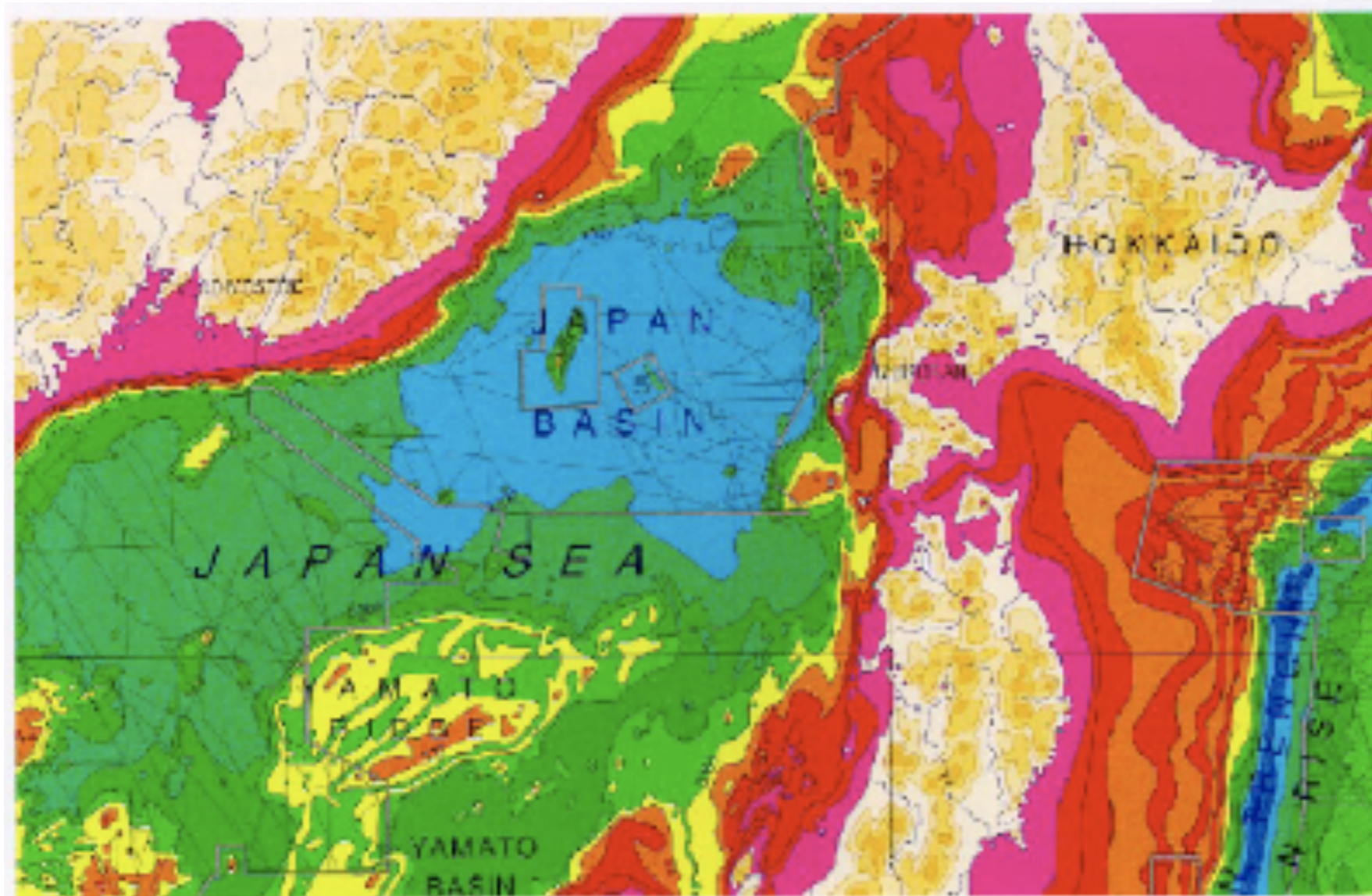
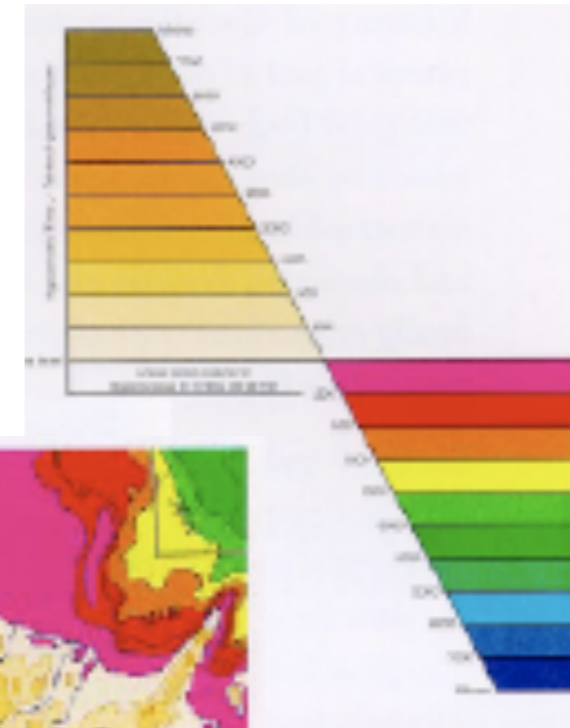

Sheelagh Carpendale



# Color Scale

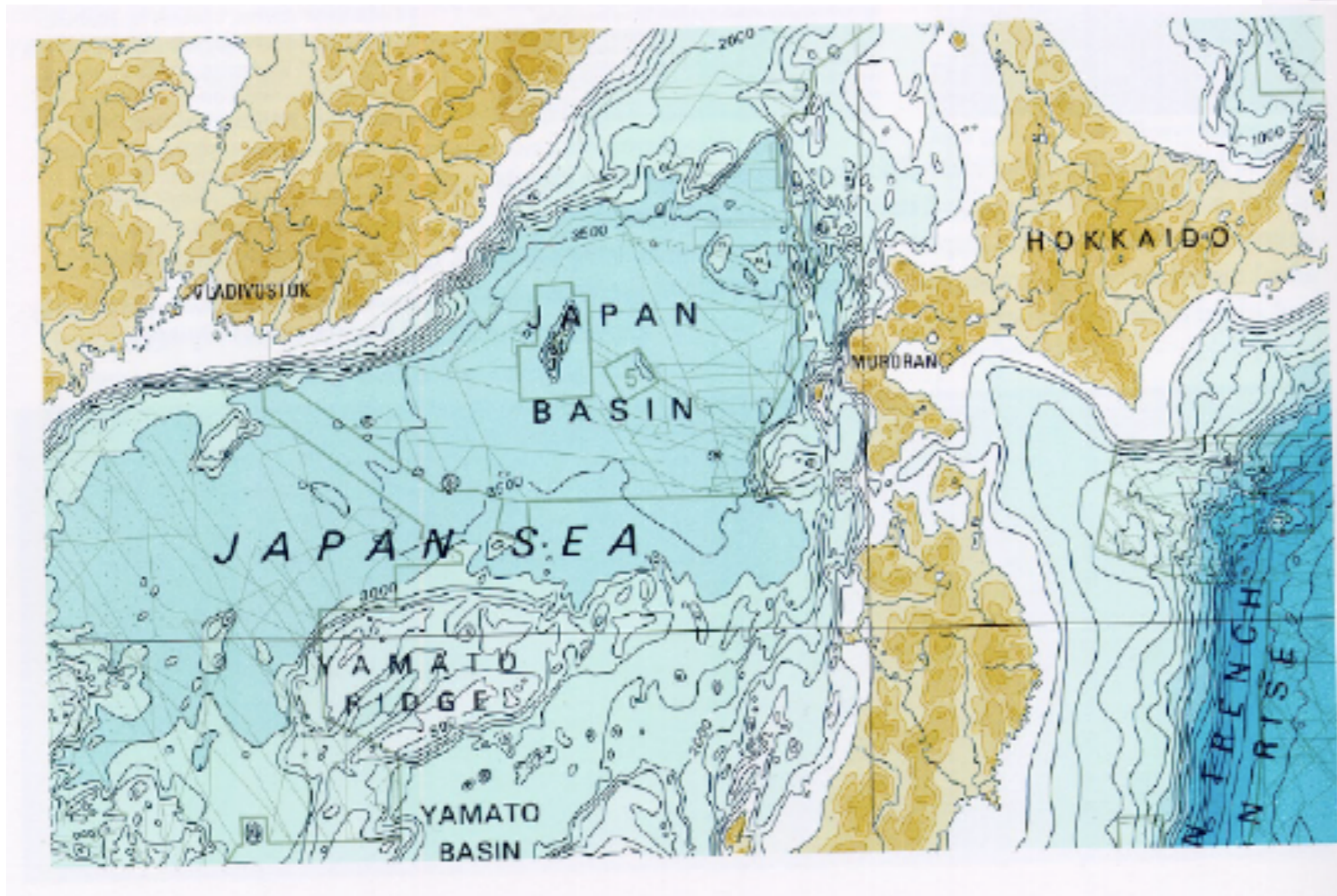
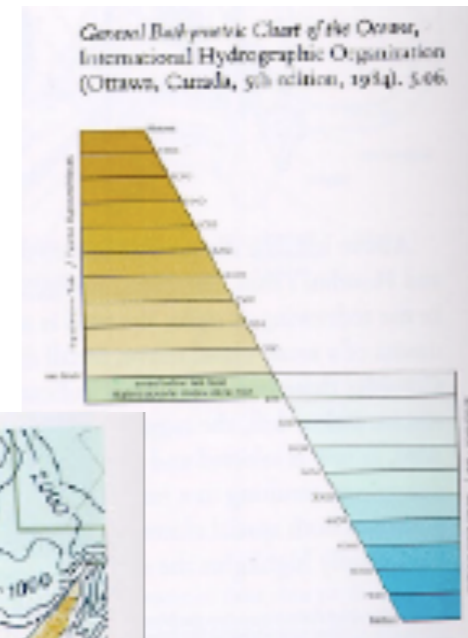

Sheelagh Carpendale

# Color Rules II

- For larger areas on a white background use low-saturation light colors
- Small color-coded objects should be given high saturation
- Use red and green in the center of the field of view (edges of retina not sensitive for these)
- Use black, white, yellow in periphery
- Use color for grouping and search
- Color Blindness Simulator: <http://www.ete.com/tools/colourblindsimulator/>
- Generation of color families
  - Use canonical colors
  - Family members should differ by saturation
  - Better: saturation and lightness

# Bivariate Color Coding

- Recap: color is three-dimensional
- Two data dimensions may be mapped to different color dimensions (e.g. hue and saturation, hue and lightness)
- Problem: bivariate color coding has been found notoriously difficult to read (Wainer & Francolini, 1980)
- The same applies to multidimensional color coding
  - E.g. amount of red, amount of green, amount of blue for coding colored dots in scatterplot (Ware & Beatty 1988)
  - Clusters could be easily identified by the participants of a user test
  - Precise decoding of the color components difficult



# Example: Bivariate Color Coding

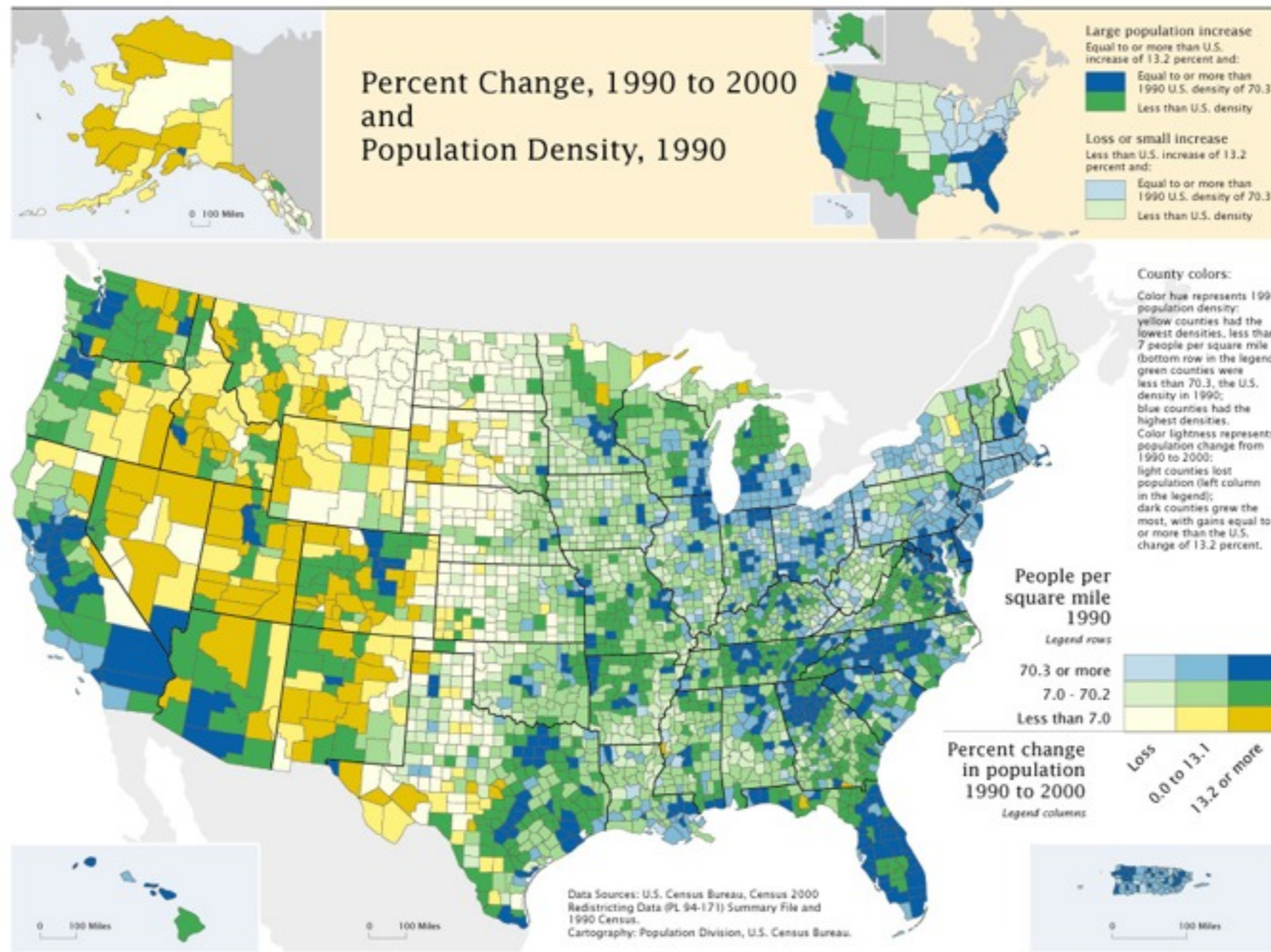

Image by Cynthia Brewer, <http://www.psu.edu/ur/2003/MapColorphotos.html>

# Outline

- Perception Definition & Context
- Preattentive processing
- Gestalt Laws
- Change Blindness
- Data encoding – glyphs
- Data encoding – color
- Characteristics of Visual Properties

# Characteristics of Visual Properties

- Some properties possess intrinsic meaning
  - Density with Grayscale: the darker the more
  - Size / Length / Area: the larger the more
  - Position: depending on culture, in Europe the leftmost / topmost are first
  - Color: depending on culture, e.g. white associated with death in Japan
- Accuracy of representations for quantitative measures (empirically verified by Cleveland & McGill, 1985)

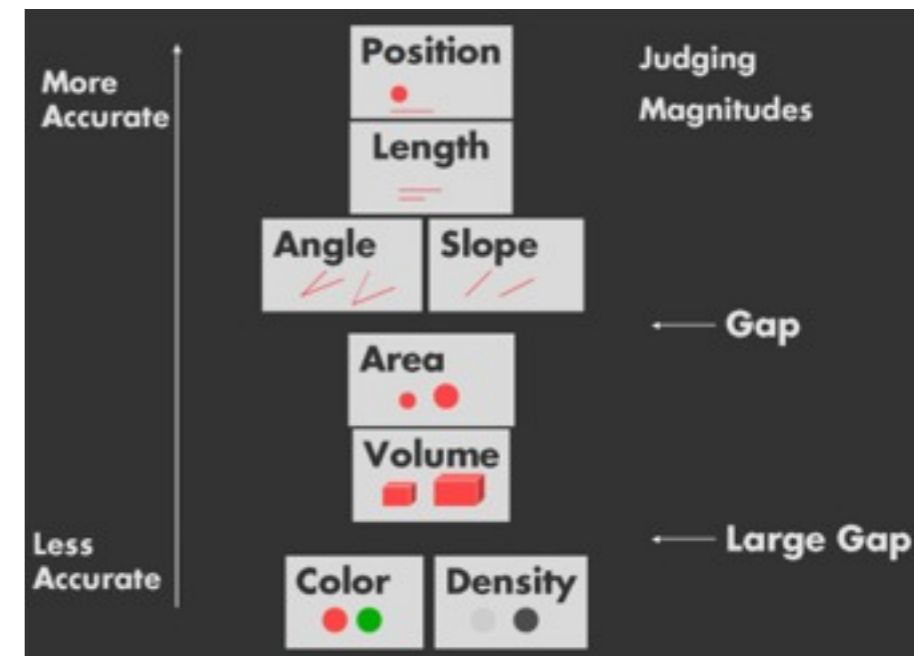

(Mackinlay, 1988)

Attribute	Quantitative	Qualitative
Line length	x	
2D position	x	
Orientation		x
Line width		x
Size		x
Shape		x
Curvature		x
Enclosure		x
Hue		x
Intensity		x

(Few, 2004)