

Instrumented Environments

Andreas Butz, butz@ifi.lmu.de, www.mimuc.de

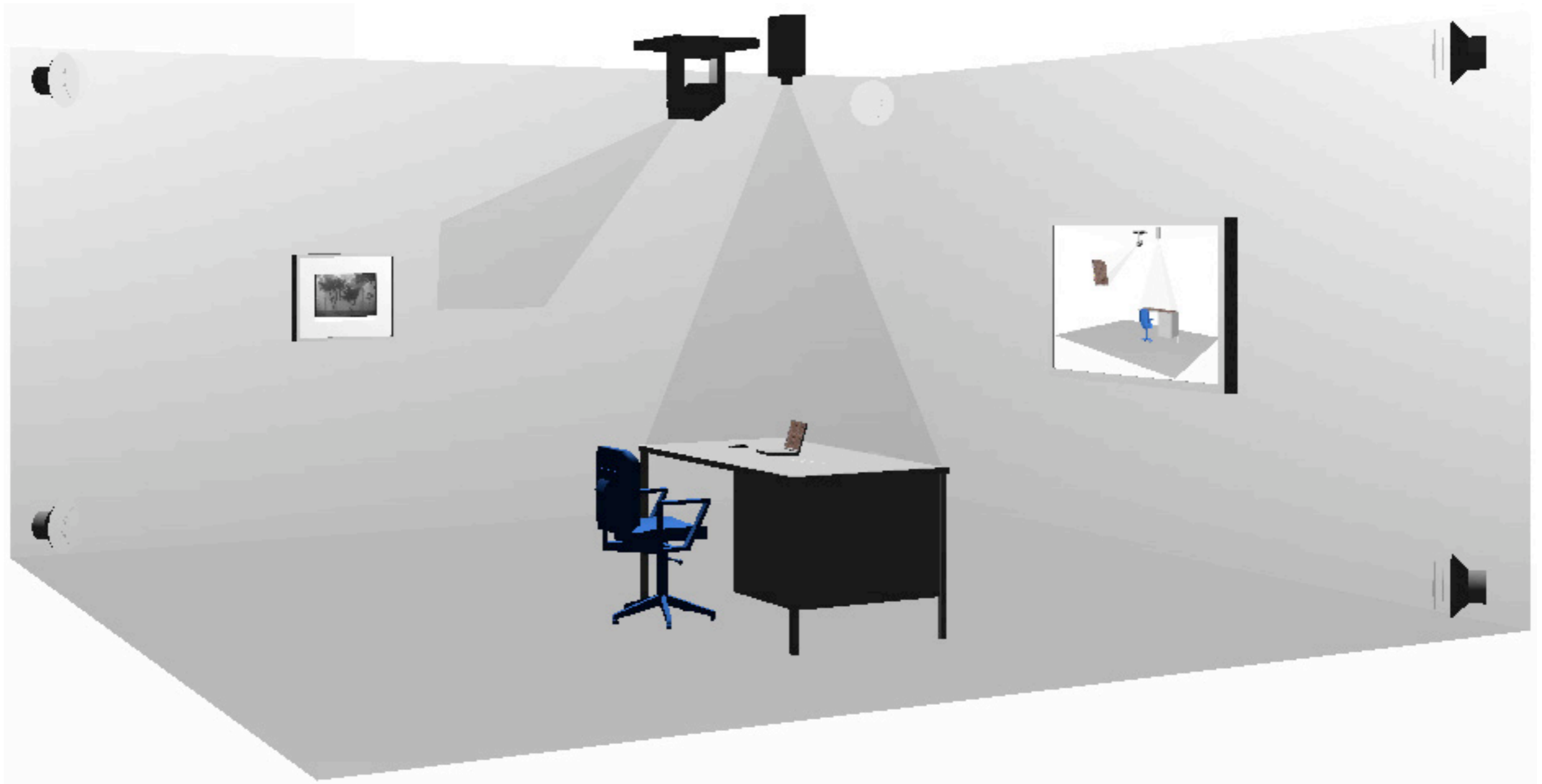

Topics today

■ Displays

- small, med, large
- digital ink, e-paper
- projection, multiple & steerable
- Fog screen
- Spatial audio

■ Sensing

- touch screens/input
- Cameras, microphones
- Force, acceleration, temperature
- RFID, NFC
- IR, BT

Displays

Tabs, pads and boards

(the Xerox ParcTab project)



Tabs



Pads



Boards

Tabs, pads...

- Tabs, inch-sized (1 Inch = 2.54 cm)
 - small handheld networked devices
- See also Active badges
 - specialized tabs, enable localization
- Pads, foot-sized (1 Foot = 30.47 cm)
 - mixture of laptop, palmtop, sheet of paper
- Introduced the concept of a disposable computer, no identity, impersonal
- Provide a solution to the lack of space on windows based systems

...and boards

- Boards, yard-sized (1 Yard = 0.914 m)
 - used as chalk boards, TVs, display boards
- Power of Ubicomp stems from the interaction of all devices.
- Ubicomp can „awake“ lifeless things (books, overhead slides, etc.)
- Problem: today it's easier to read a book than to sit down at a complicated Personal Computer
- Transition will happen in small steps

More ubicomp displays



retinal displays



clip-on

Retinal displays

1. DRIVE ELECTRONICS

The drive electronics acquire and process signals from an image source, then synchronize the color mix, gray-level and placement of individual picture elements (pixels) that comprise the image. The image source may be from a computer, video camera or almost any video input.

2. LIGHT SOURCES

In a full-color display, pixels are generated by modulated light sources that vary the intensity of red, green and blue light - producing a wider range of the color palette than any other display technology. The light sources used in the VRD operate at safe, extremely low intensity levels.

4. OPTICS

Refractive and reflective optics direct the light beam into the viewer's eye, projecting an image through the viewer's pupil onto the retina.

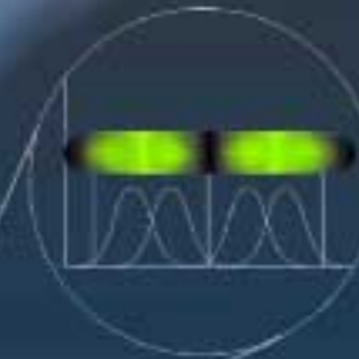

3. SCANNERS

A horizontal scanner sweeps the light beam into a row of pixels, and a vertical scanner moves the light beam to the next line, where another row of pixels is painted. In a VGA display, more than 18 million pixels per second are formed, projected and arranged on the retina - with exacting precision.

Electronic-ink

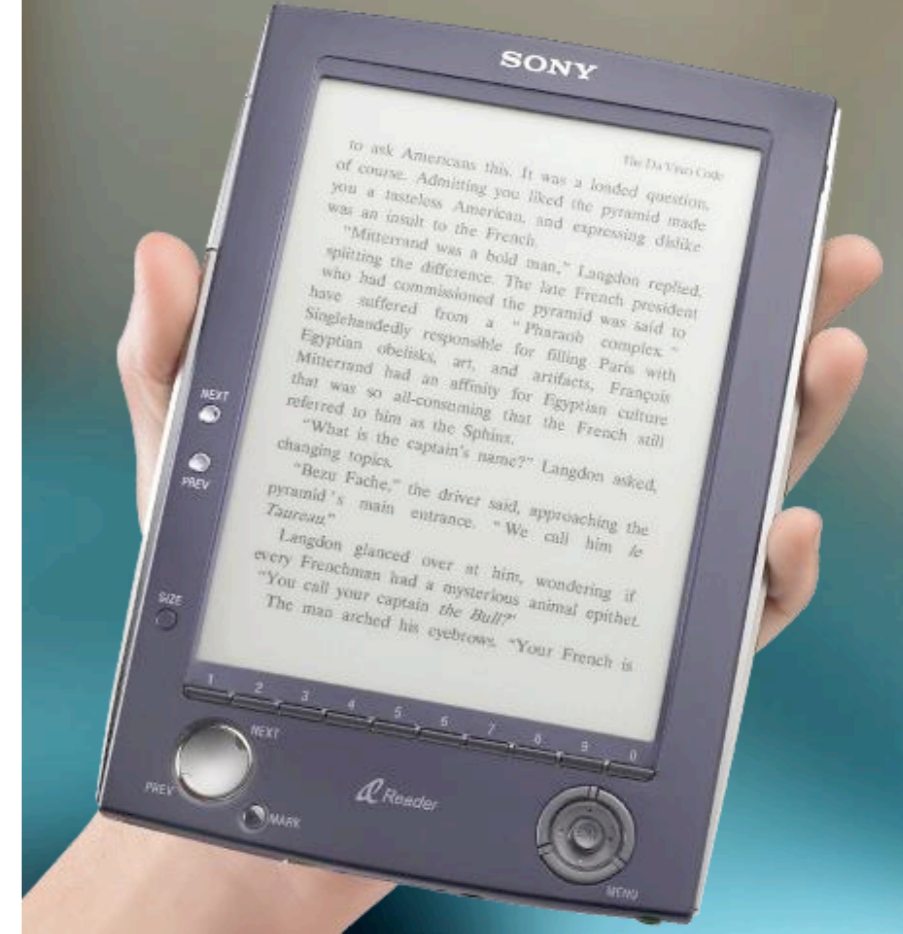

Cross-Section of Electronic-Ink Microcapsules

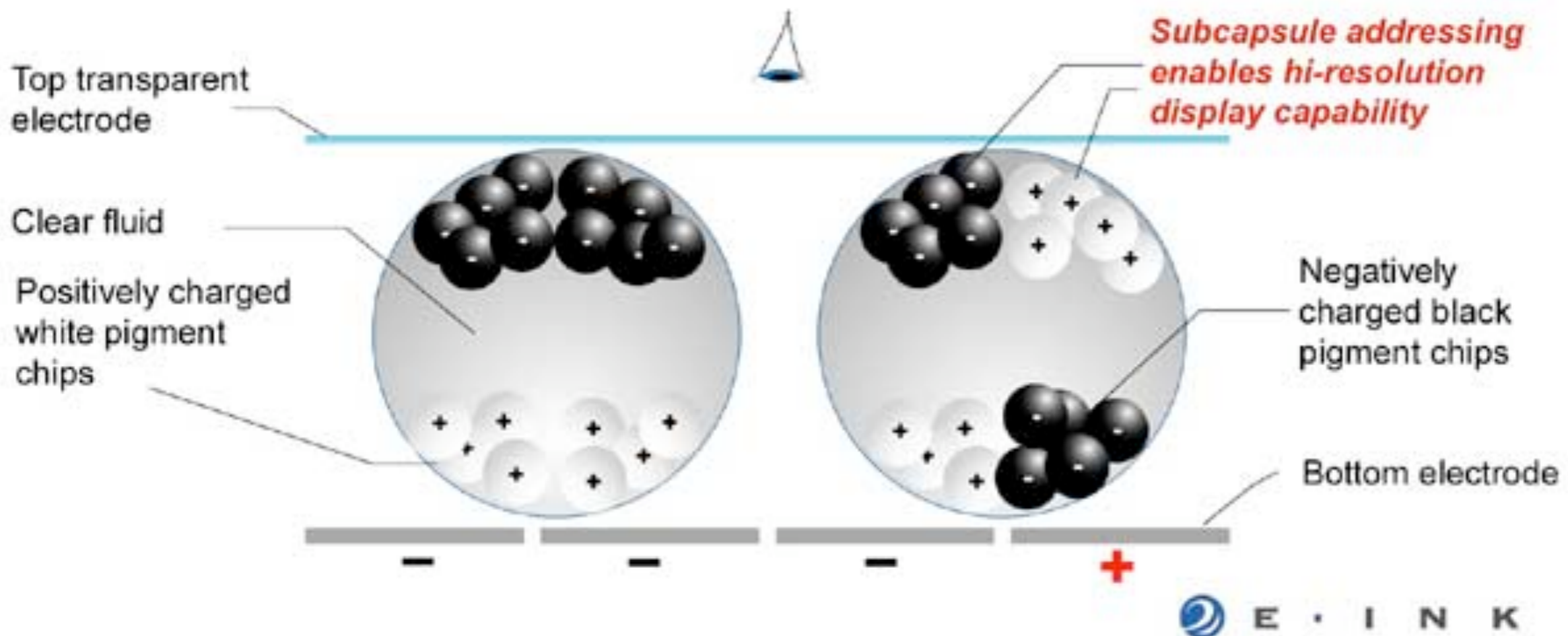

Projectors

■ Key Criteria

- Resolution
- Brightness
- Weight
- Noise
- Lens
- Image correction
- Projection distance
- Connections
- Lamp life time



CRT projector

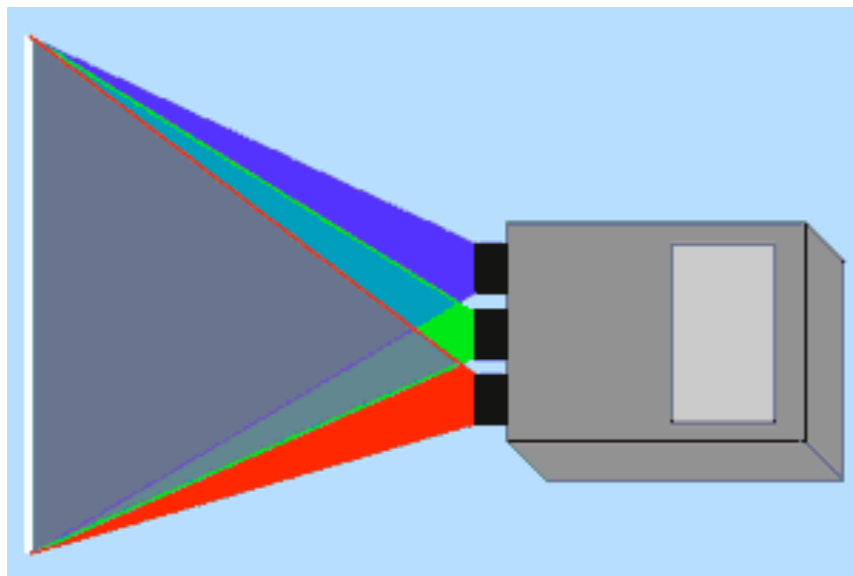
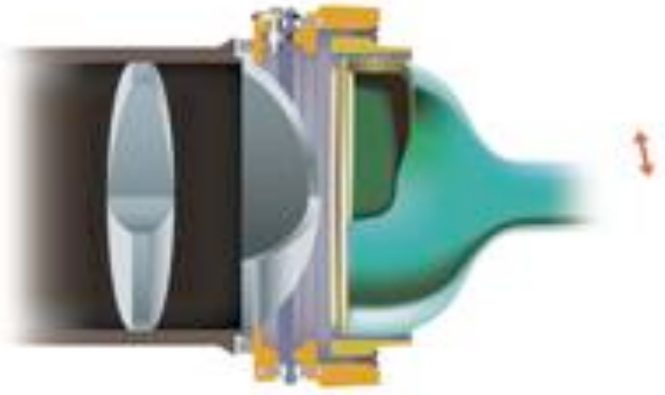

- Use R,G+B CRTs as light sources
- Good black areas
- Low brightness
- Fast
- Need to calibrate convergence!

www.projektoren-datenbank.com/rohre.htm

LCD projector

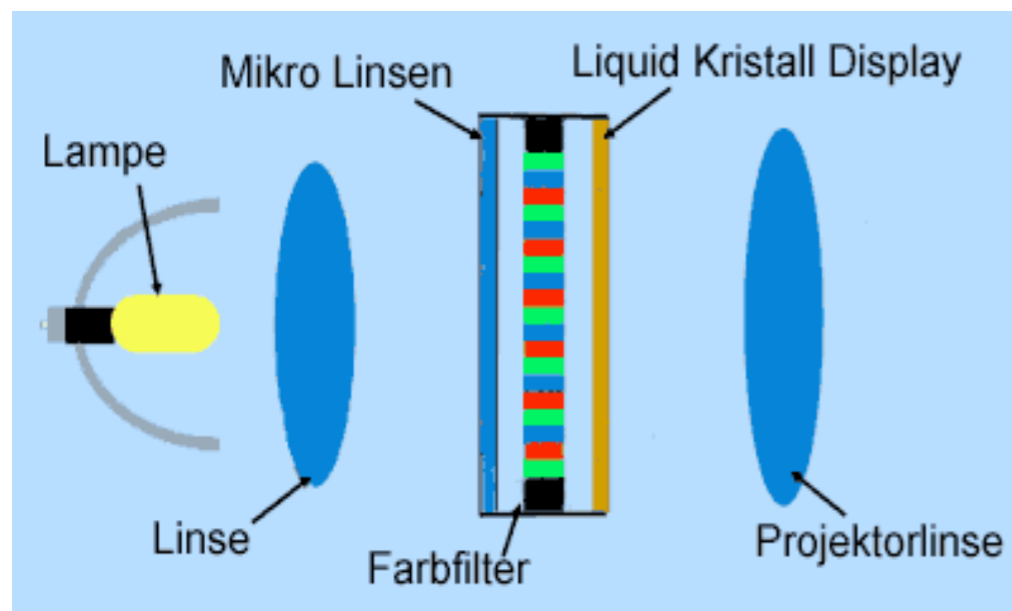

www.projektoren-datenbank.com/lcd.htm

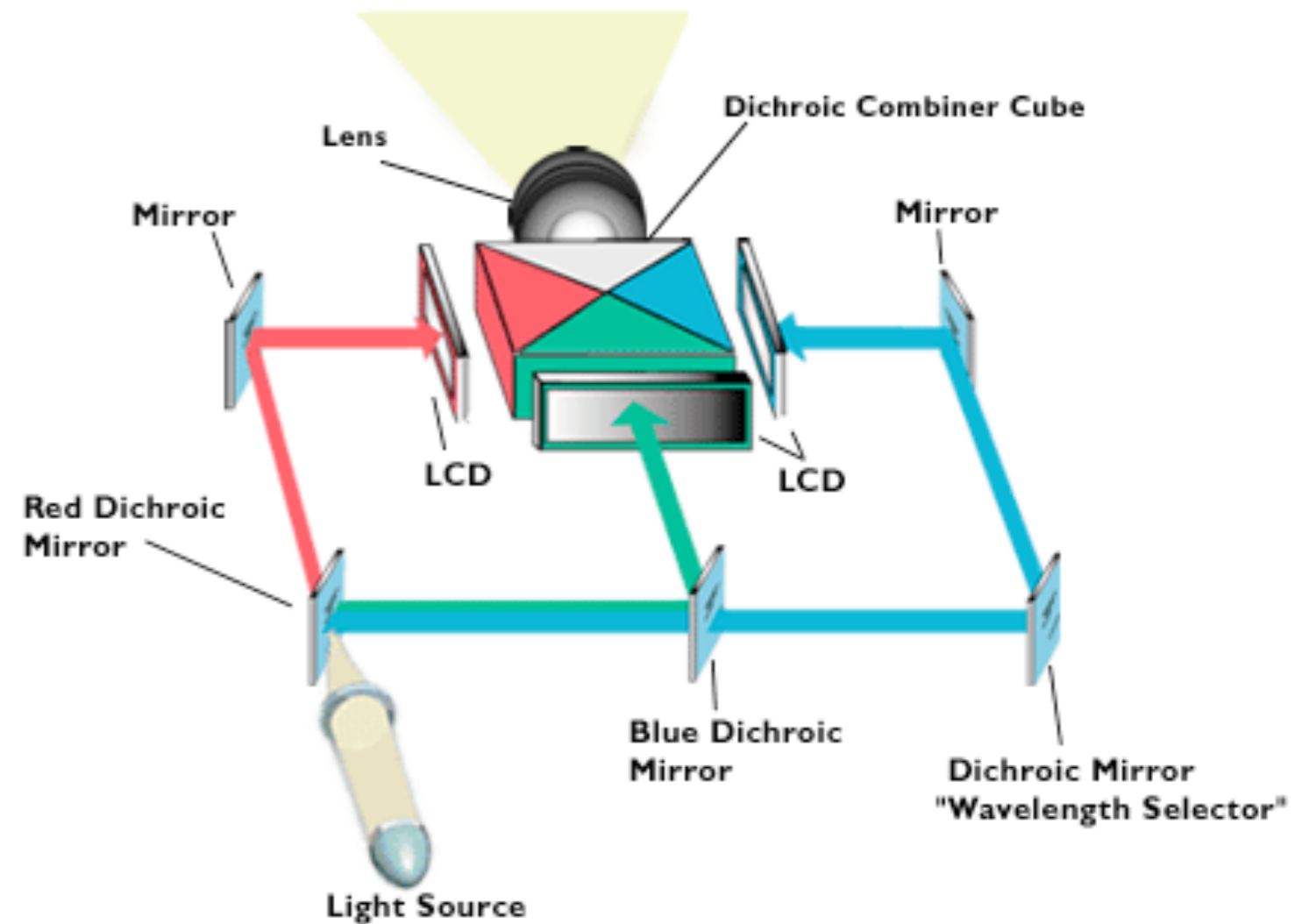

www.projectorpoint.co.uk/projectorLCDvsDLP.htm

DLD projector (movie)

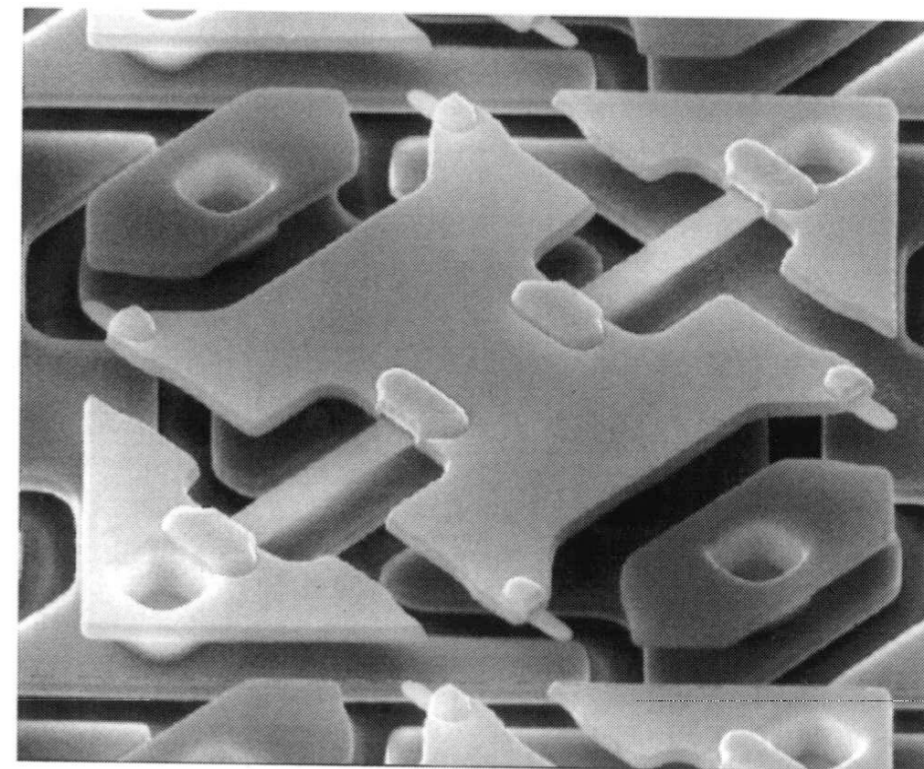
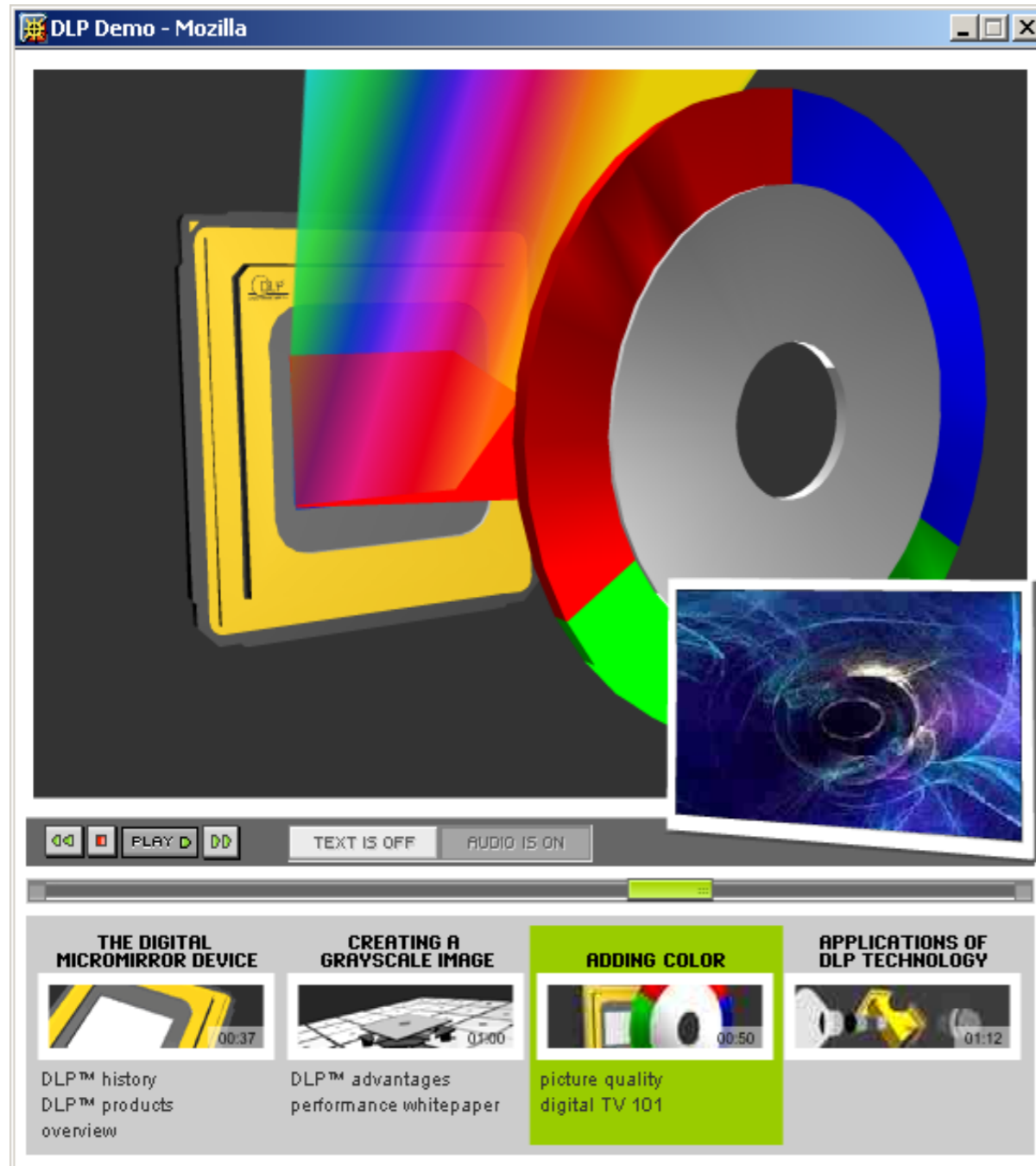

<http://www.dlp.com/>

Technological side effects

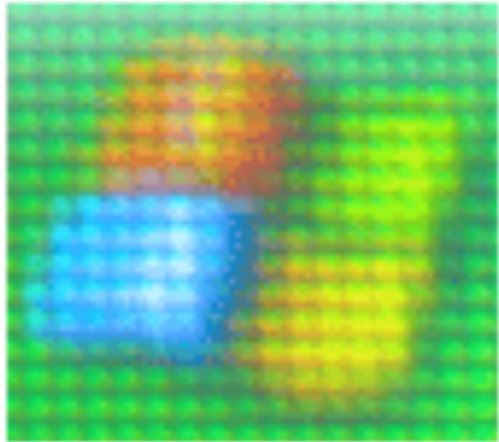

LCD



DLP

(image is a magnified portion of the start up icon)

- Screen door effect
 - Caused by LCDs
 - Less prominent in DLP

- If a DLP projector is moved, color seams appear

A



- DLP principle can be abused for creating imperceptible structured light

Lens shift

- Optical construction
- No loss of resolution

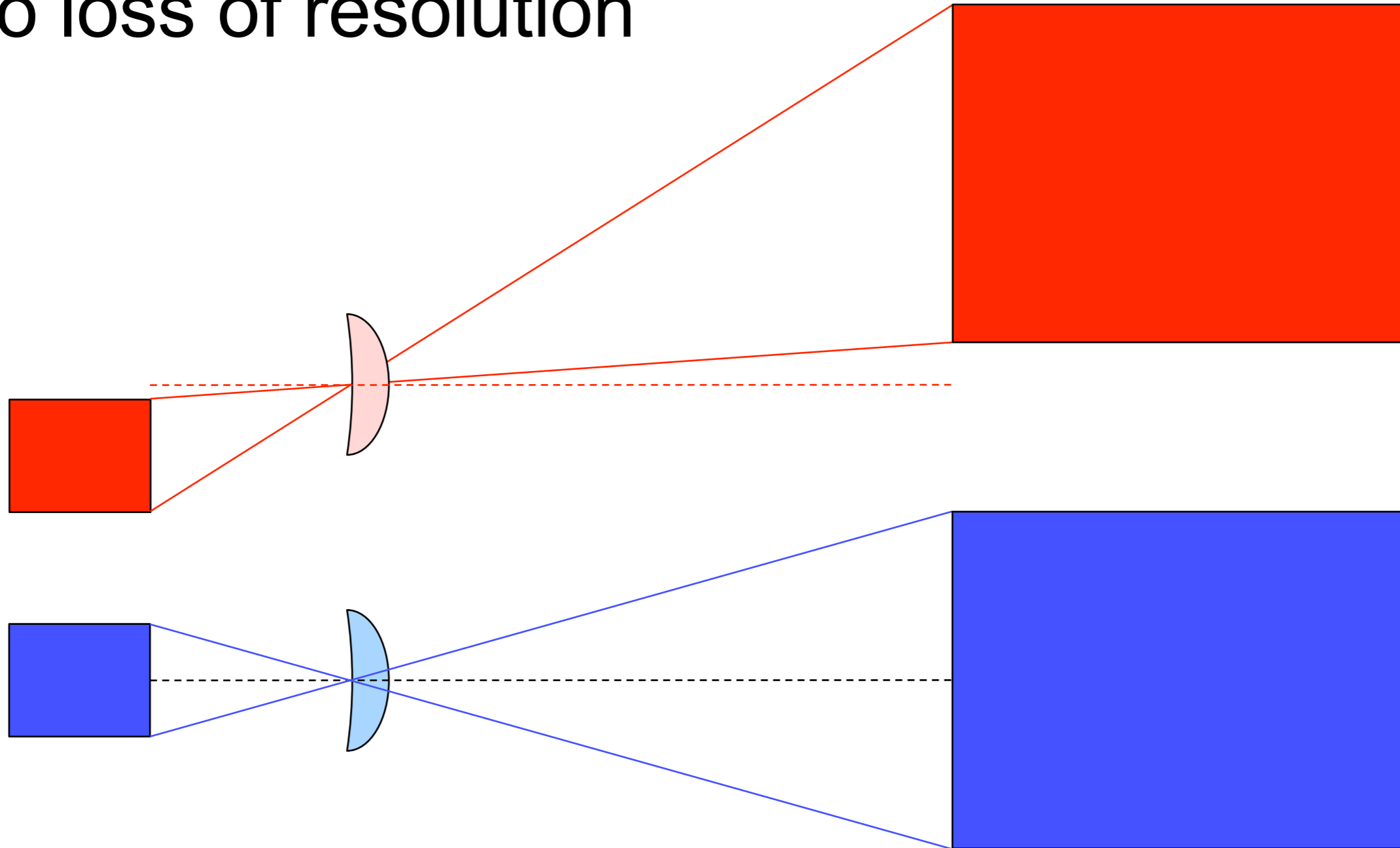

Keystone correction

- Computed correction
- Loss of resolution!

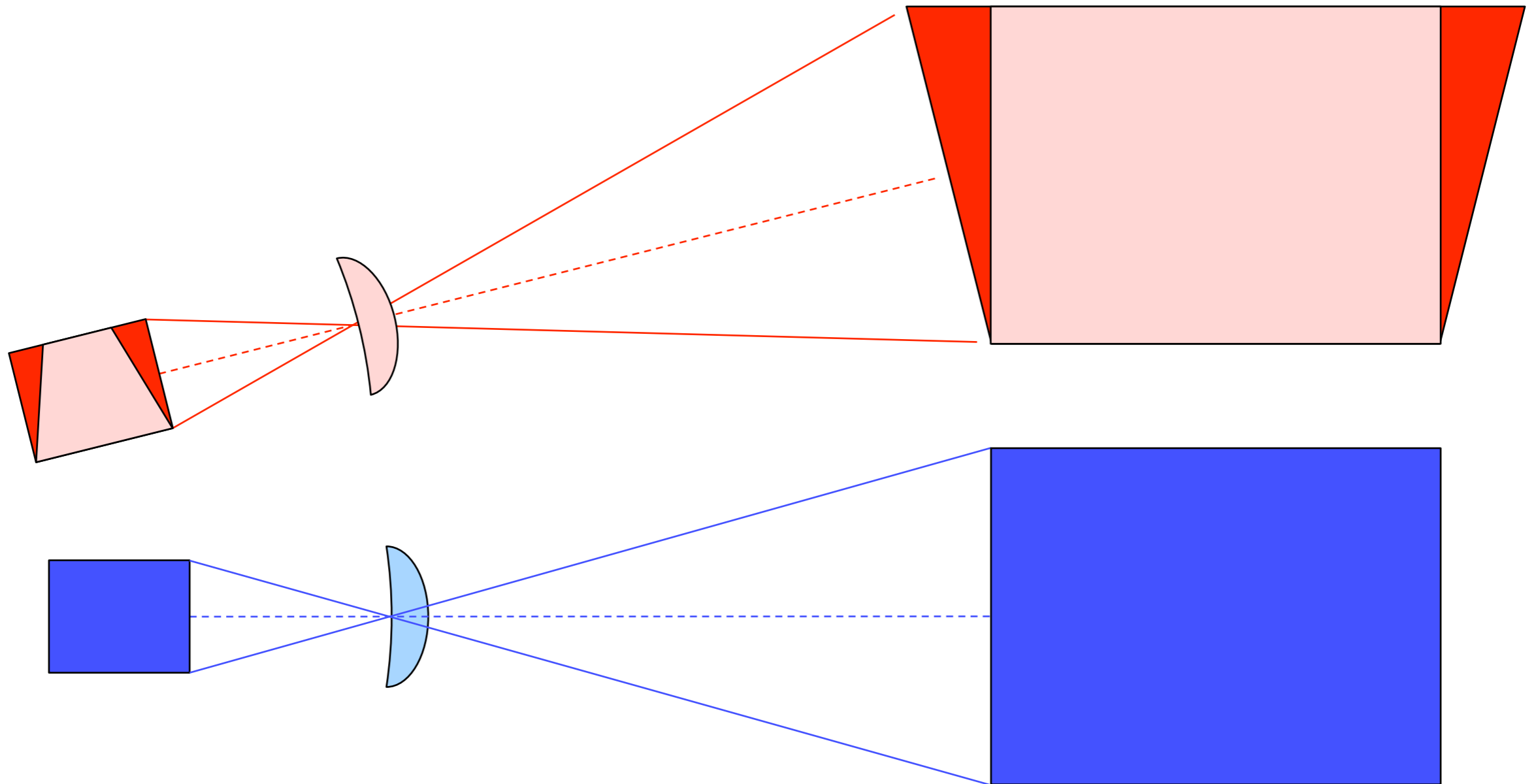

Smart Projectors

[Oliver Bimber et al., IEEE Computer, January 2005]

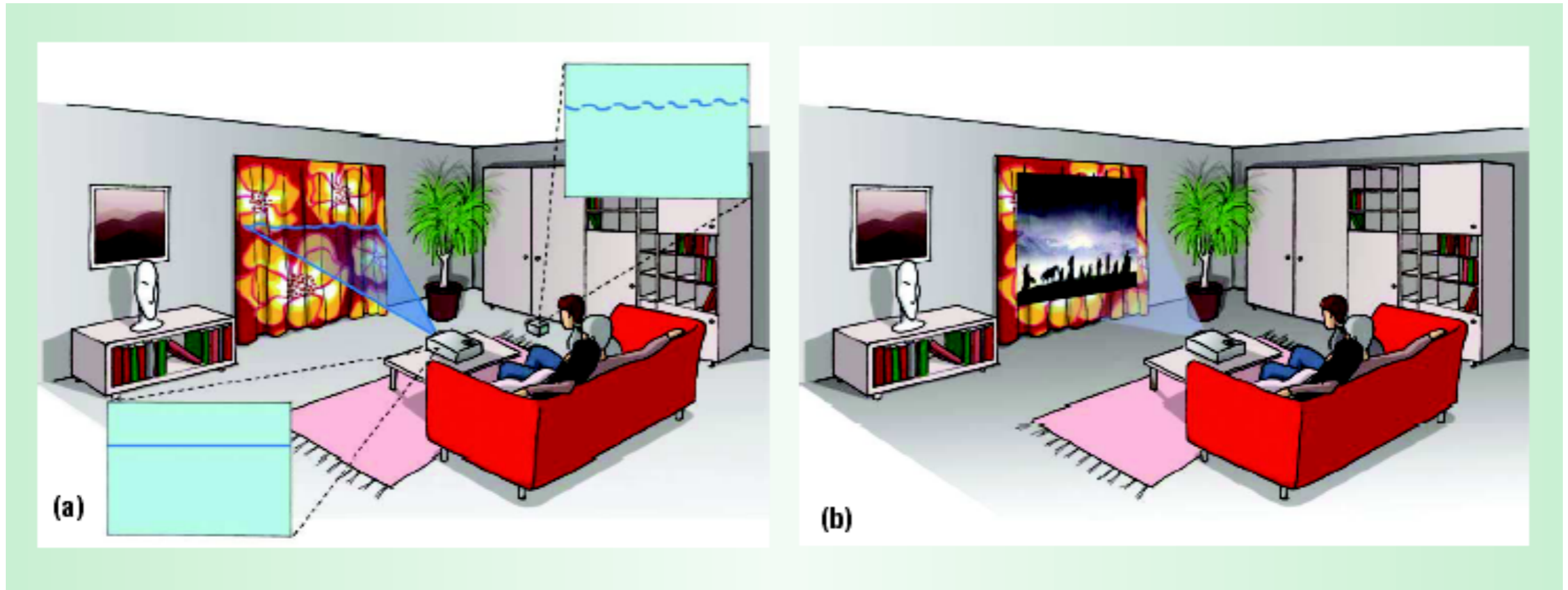

- Projection onto curved surfaces can be solved by 3D rectification, ...but:
- What if the projection surface is not uniformly colored?
- See Video (scientific) or Video (TV)

Multiple Projector setups

- Several problems:
 - Overlapping projection areas
 - No color equivalence between two projectors (manufacturing & temperature color drift)
 - Minimize sensitivity to small errors in calibration parameters or mechanical variations
- Relatively good solution: Feathering

Feathering

- Normally the overlap region is a well-defined contiguous region
- Intensity of every pixel weighted proportional to Euclidian distance to nearest boundary pixel of image
- Weights in range $[0, 1]$ multiplied with intensities in the final image

Feathering

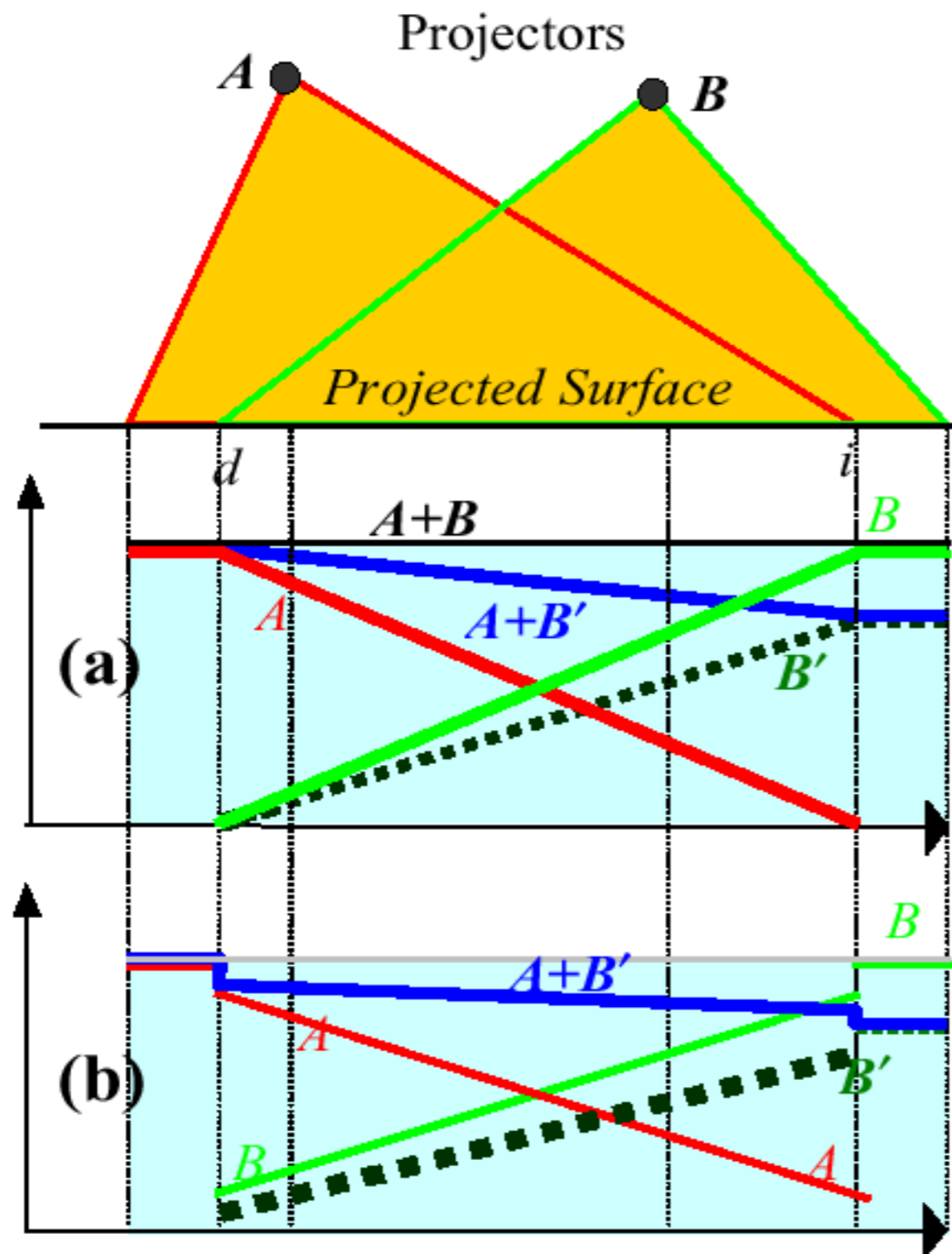

- If both projectors produce same color, $A+B$ at maximum and constant over surface
- If not $A+B'$ produces smooth transition

Luminance Attenuation Map

[Majumder & Stevens, VRST 2002]

- Large display wall with 5x3 projectors
- Linear ramps (feathering) don't work perfectly
- Goal: get rid of the remaining unevenness
- Strategy: don't assume, but measure!



Calibration step

- **Measuring the Luminance Response:** The *luminance response* of any pixel is defined as the variation of luminance with input at that pixel. We measure the luminance response of every pixel of the display with a camera.
- **Finding the Common Achievable Response:** We find the common response that every pixel of the display is capable to achieving. The goal is to achieve this *common achievable response* at every pixel.
- **Generating the Luminance Attenuation Map:** We find a luminance attenuation function that transforms the measured luminance response at every pixel to the common achievable response.

Measured luminance response

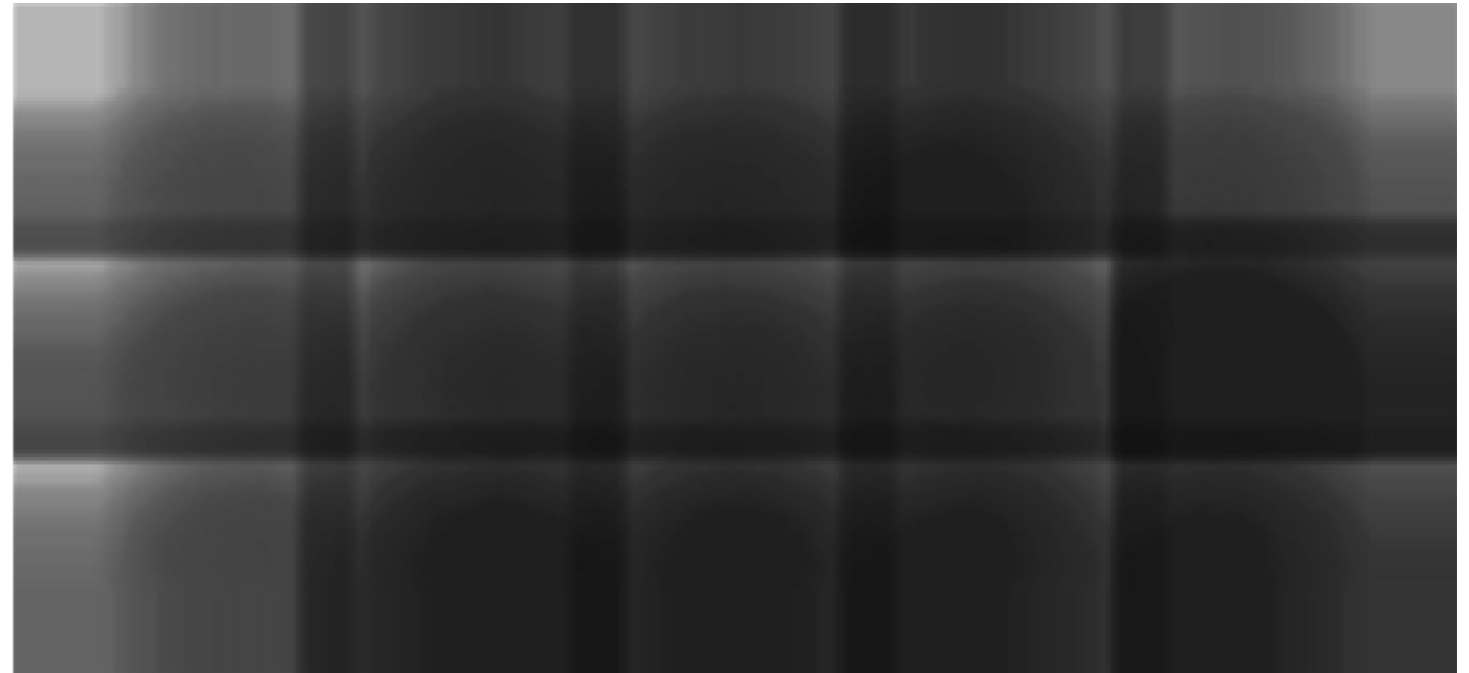
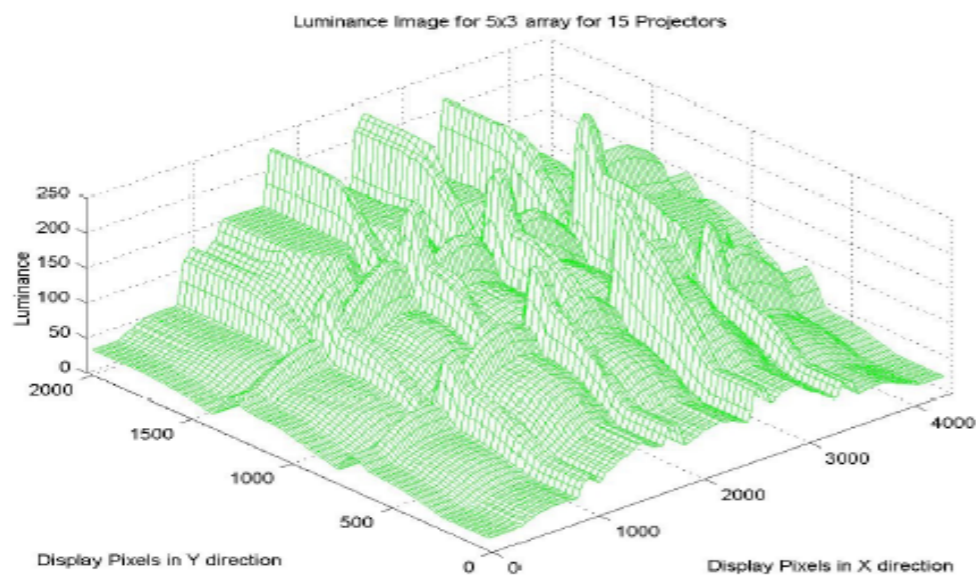

- Gives a factor for multiplication of the final images (just as in feathering)
- Can be done in graphics hardware via alpha channels

LAM: results



PixelFlex2

[Raij, Gill, Majumder, Towles, Fuchs, ProCams 2003]

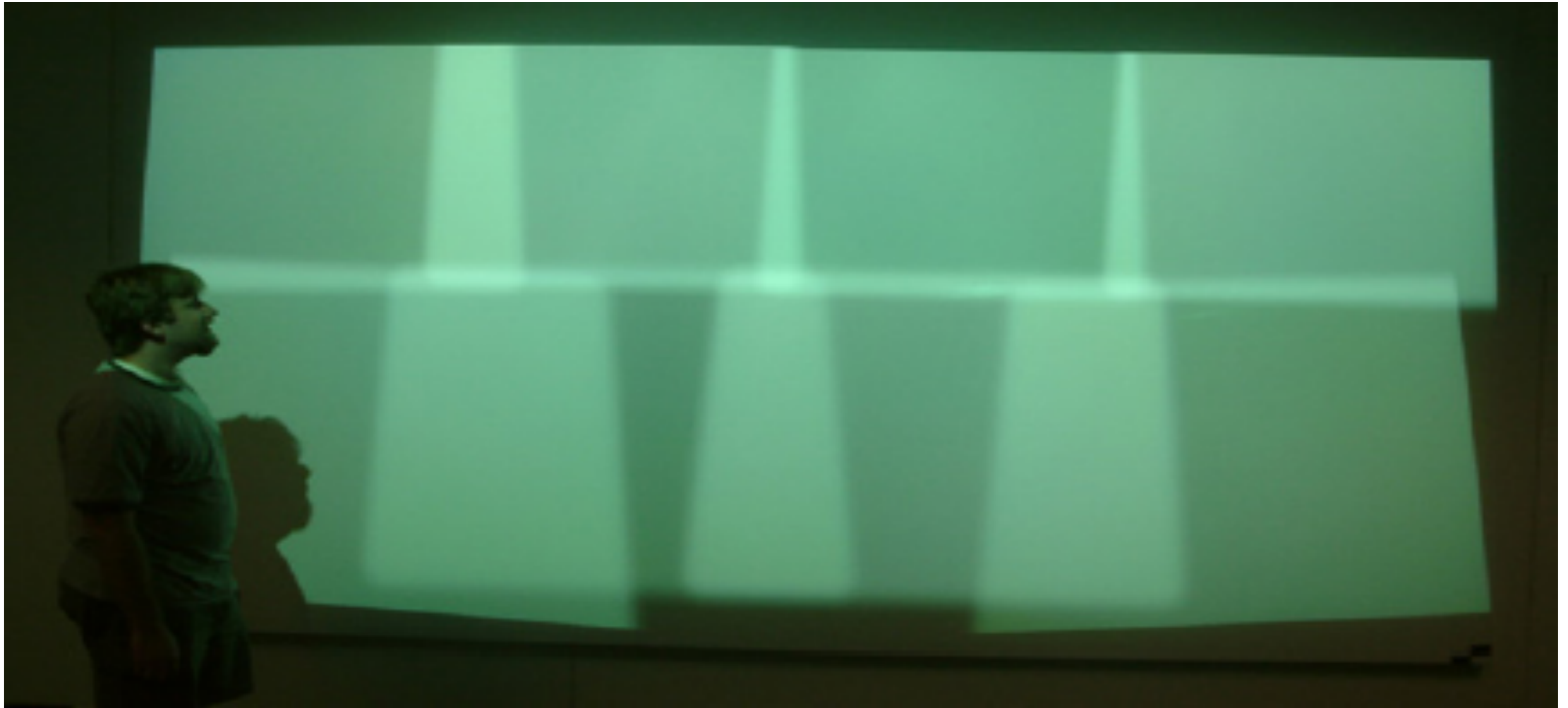

- Uneven brightness and arbitrary geometry:
 - Rectify each projector by calibrating 4 points
 - Used LAMs for brightness

PixelFlex2



Barco PowerWall

(as seen at the Univ. of Konstanz)



Barco PowerWall (back side)



PowerWall Specs

- Size: 5,20m x 2,15m
- 4640 x 1920 Pixels
- 8 computers
- 8 synchronized projectors
- „Soft-Edge-Blending“ in the projectors
- Stereo display with shutter glasses
- Must not be touched 8(
- Price: ?00.000,00 €



Everywhere Display Projector (IBM)

<http://www.research.ibm.com/ed/>

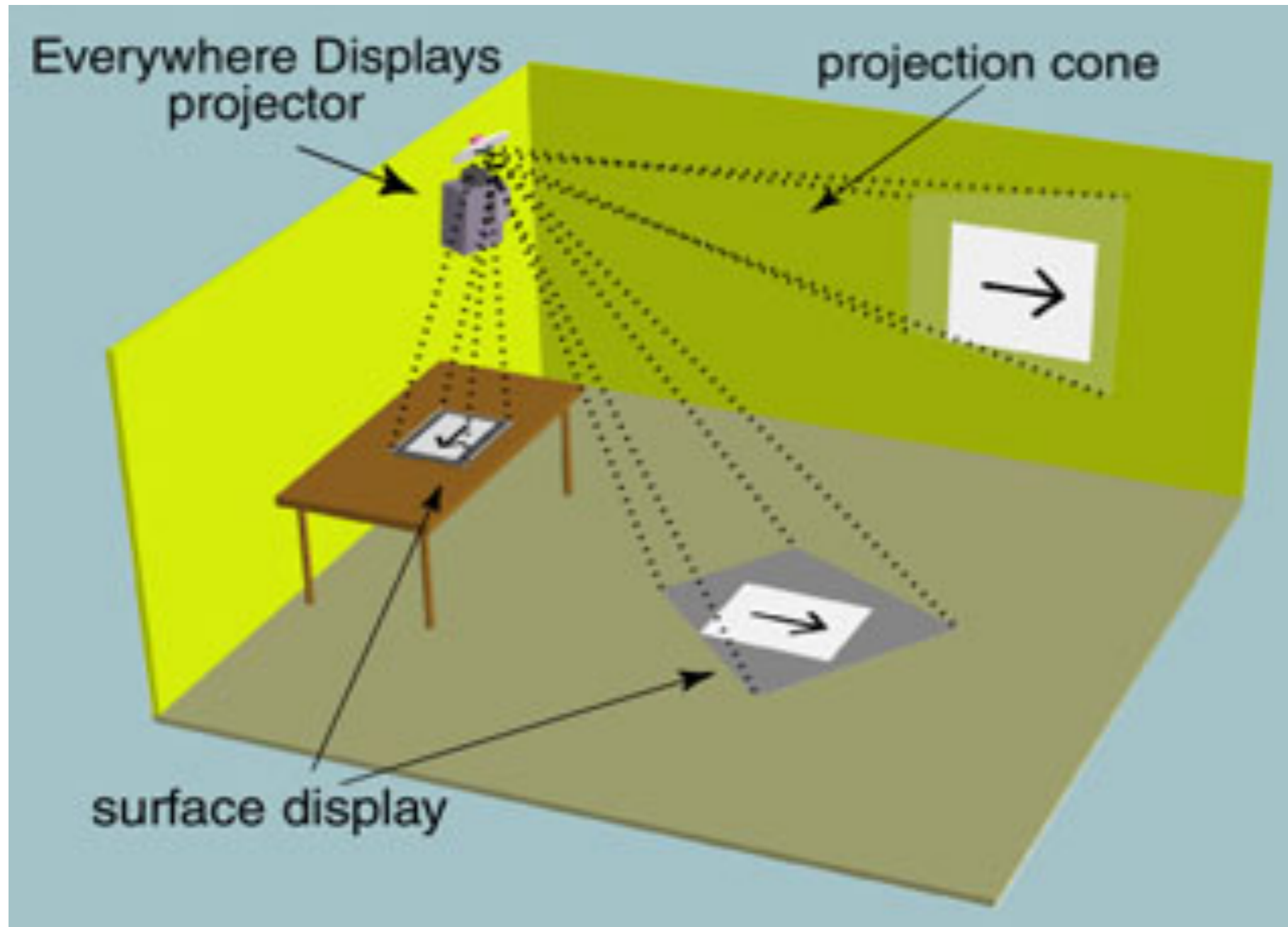

Claudio Pinhanez

Everywhere display (cont.)

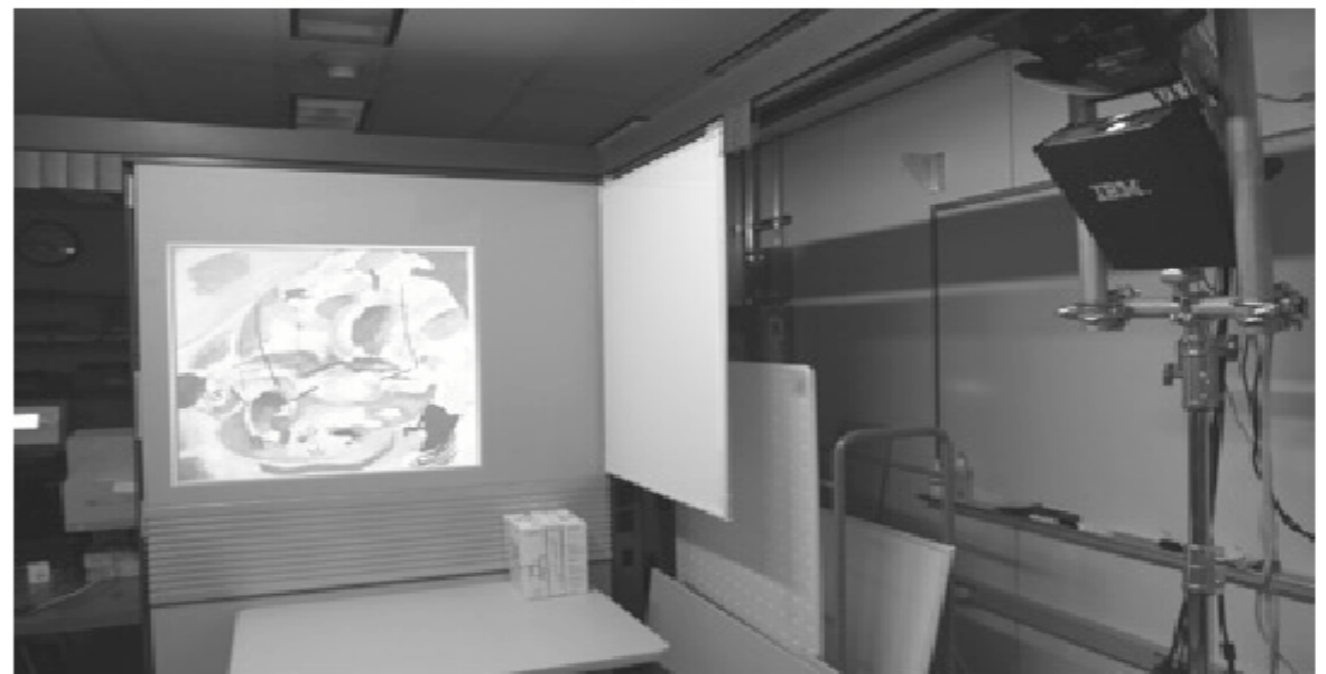

Output: a projector and a rotating mirror

Input: a camera for interaction, NOT for image rectification!

Undistorting the projected image

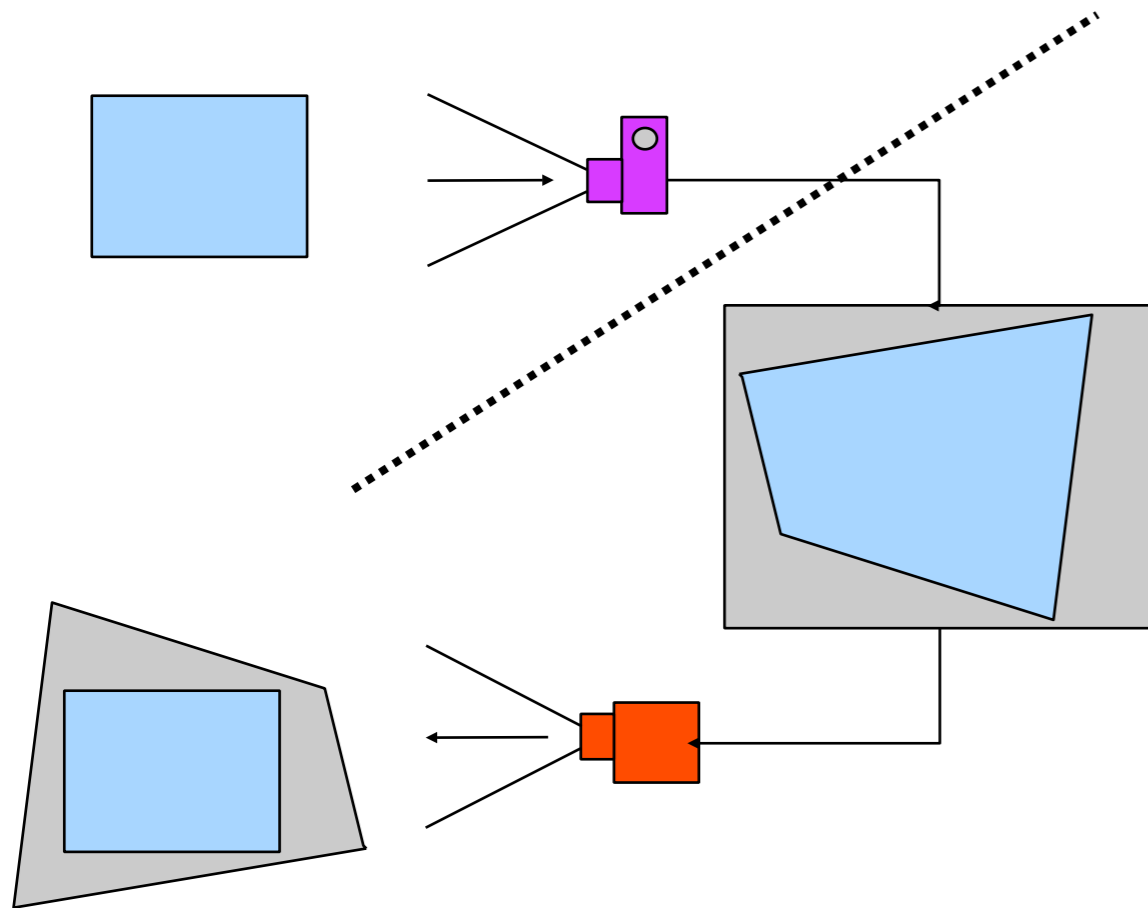

- Place original image in the **3D model**
- **Virtual** camera image shows it distorted
- Project the distorted image from 3D model with the **Real** projector into the **real world**

– Distortions cancel each other out IF **virtual** camera and **real** projector are in the same location

Everywhere display (cont.)

- Correct distortions
 - Use the fact that camera and projectors are geometrically the same (optically inverse)
- Use standard HW components
 - 3D-Graphics board and VRML-world

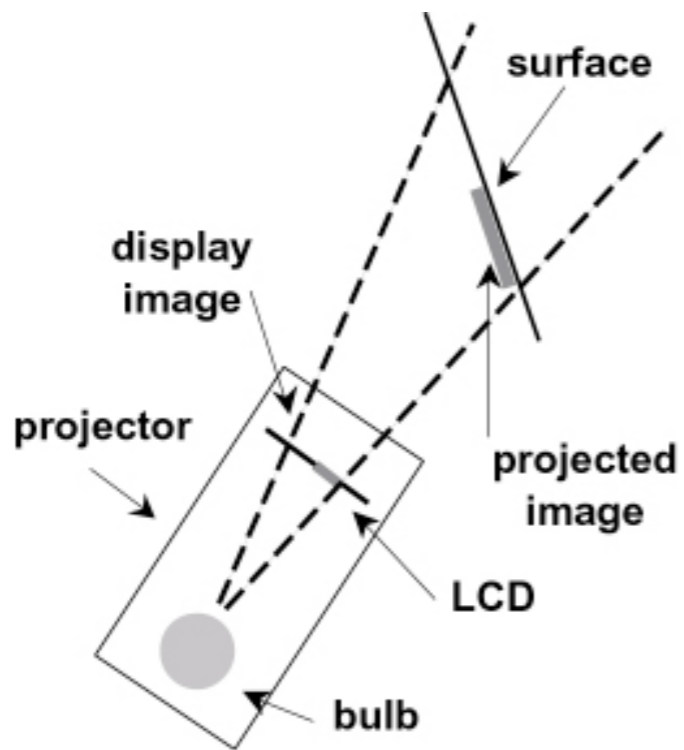

REAL WORLD

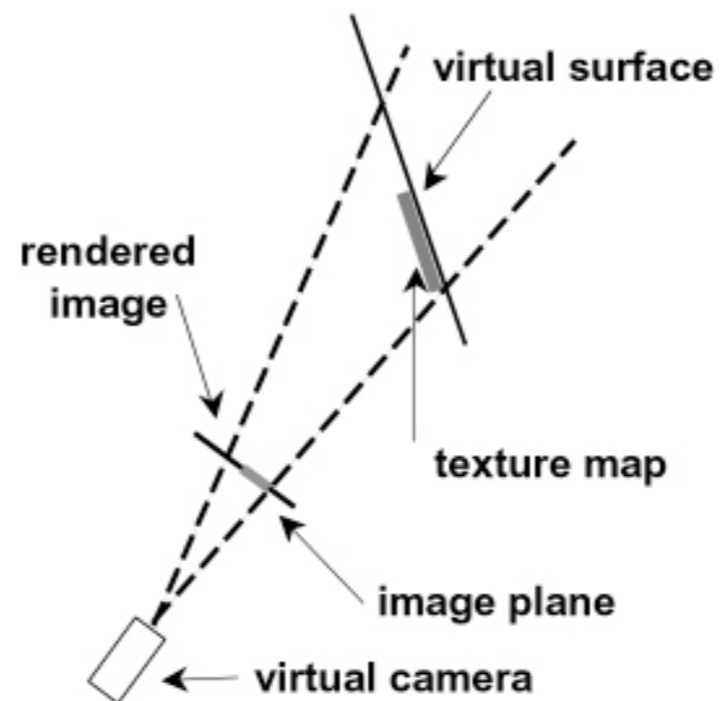

VIRTUAL 3D WORLD

Everywhere display (cont.)



BLUESPACE office scenario

Everywhere display (cont.)

Collaborative experience at SIGGRAPH 2001

1

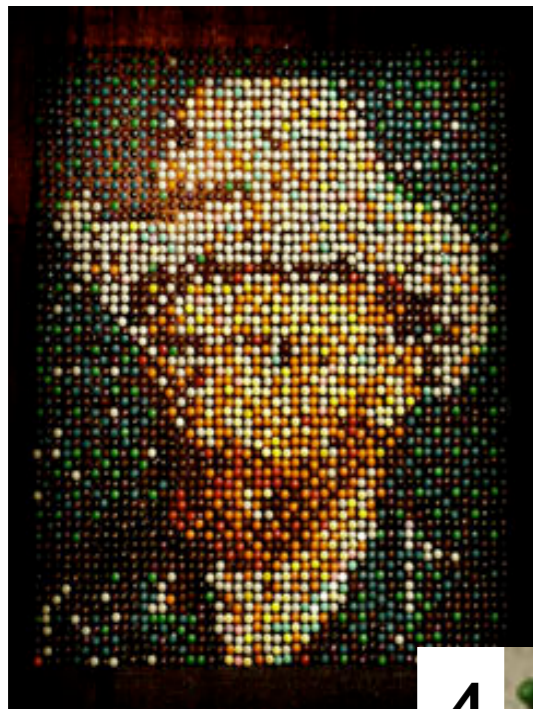

2



3

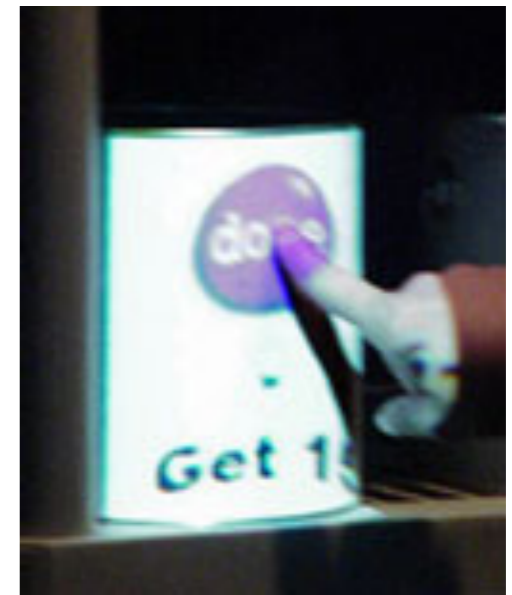

4

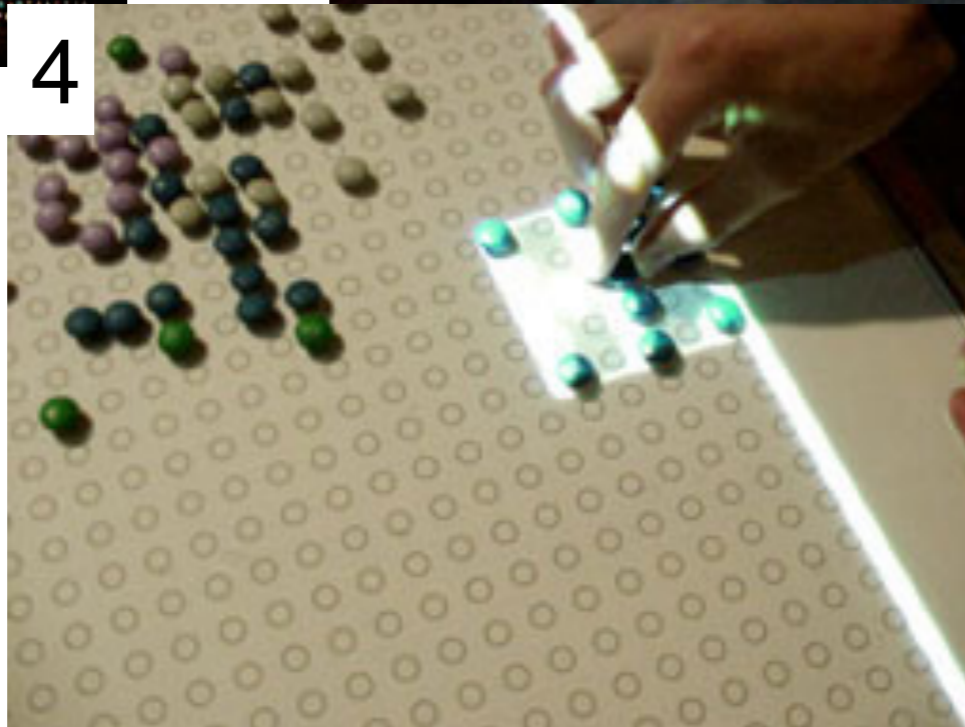

5



Video

Everywhere display (cont.)

Other Applications

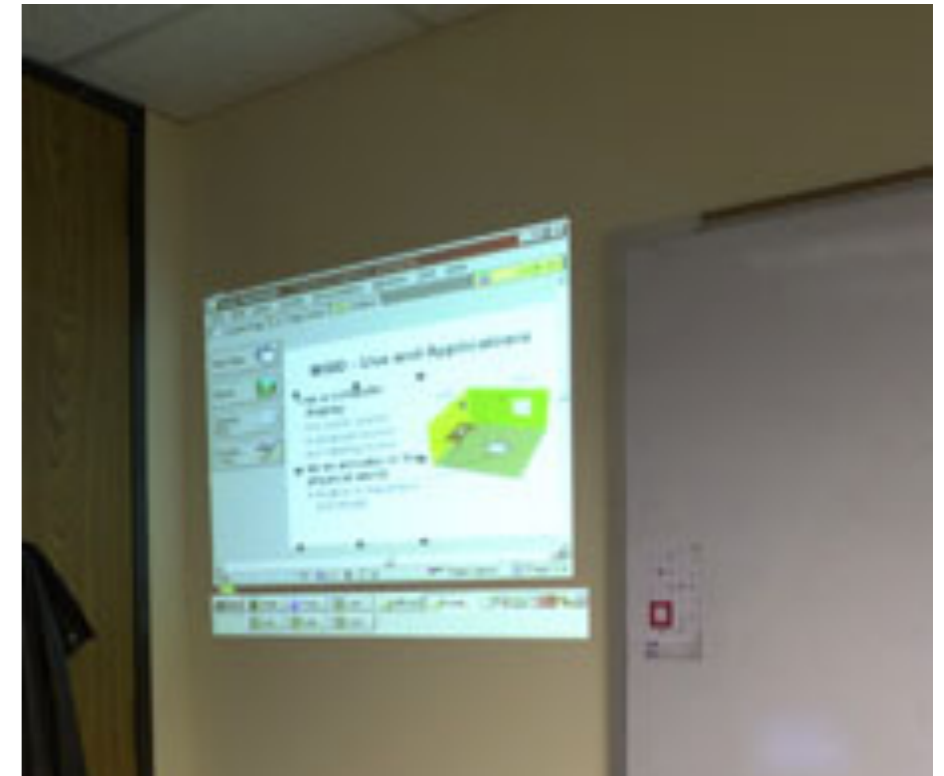
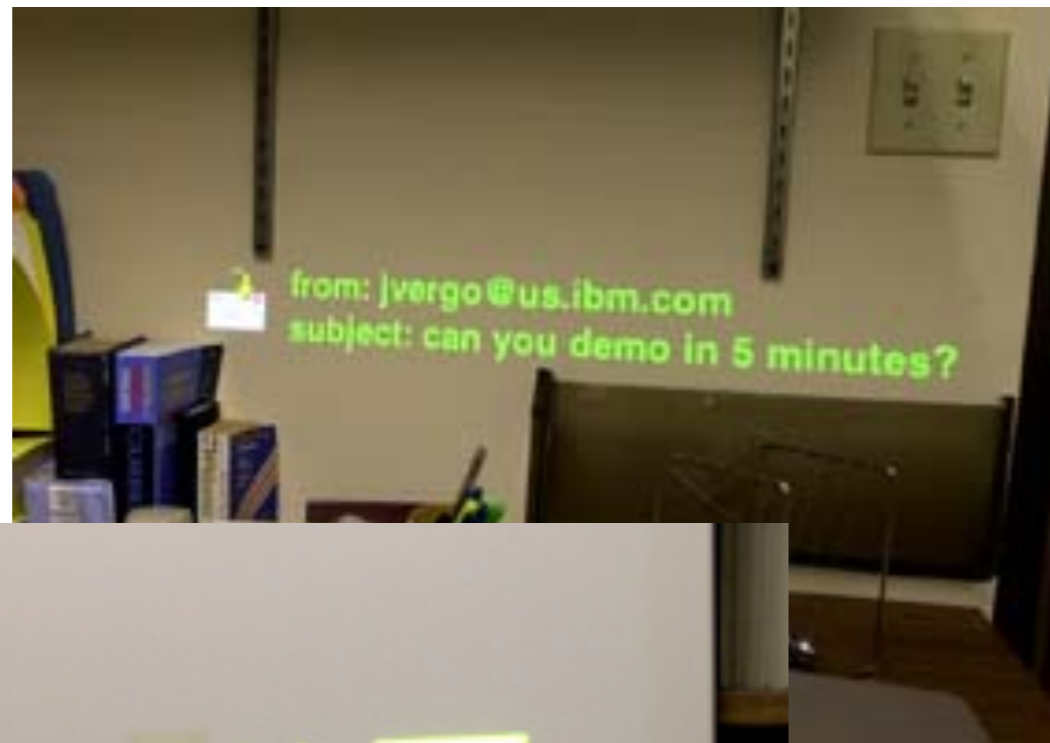

<http://www.research.ibm.com/ed/>

Steerable projector/camera unit

(as used in the FLUIDUM instrumented room)

- Projector (3.000 ANSI lumen, XGA resolution)
- Digital camera (if needed, 8 megapixels)
 - Also yields live video stream
- Moving yoke
 - Used for spotlights on stages
 - Steerable via DMX bus
 - Pan 340° / tilt 270°
 - Ca. 1 rotation in 1s
 - Mechanical precision:
+/- 1cm on the wall



Portable Display Screen

[Borokovski, Crowley, INRIA]



Tilt Stepper-motor

Support frame

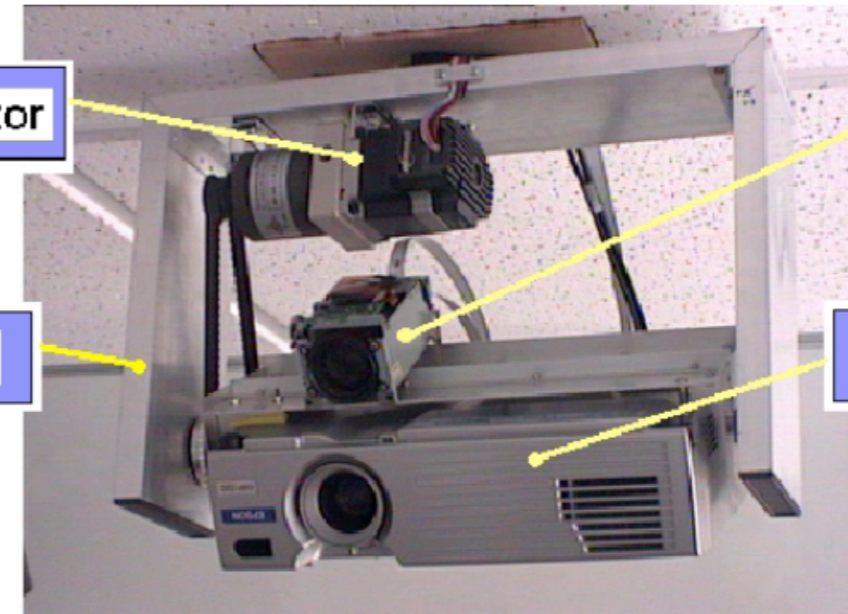

Camera

Video Projector

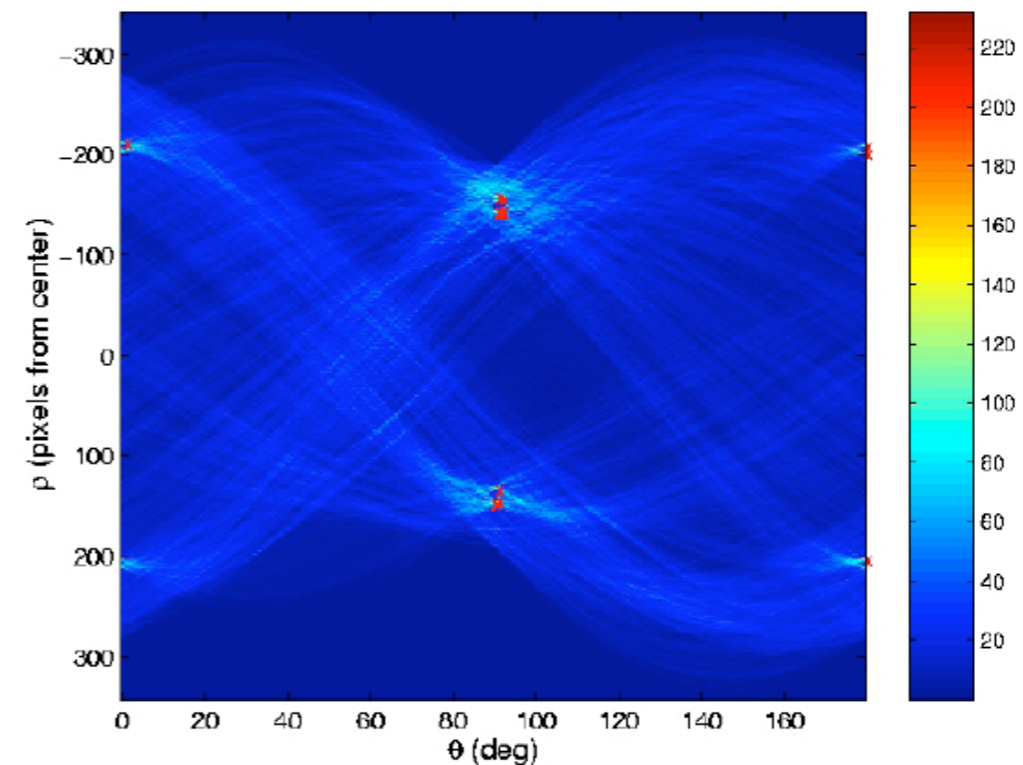

Roomware

Streitz et al., FhG



Connectable Displays

Streitz et al., FhG



Single usage



Connected usage

FogScreen

- A wall sized, immaterial projection display
- Image projected on dry, non-hazardous fog (pure water)
- Inventor: Ismo Rakkolainen

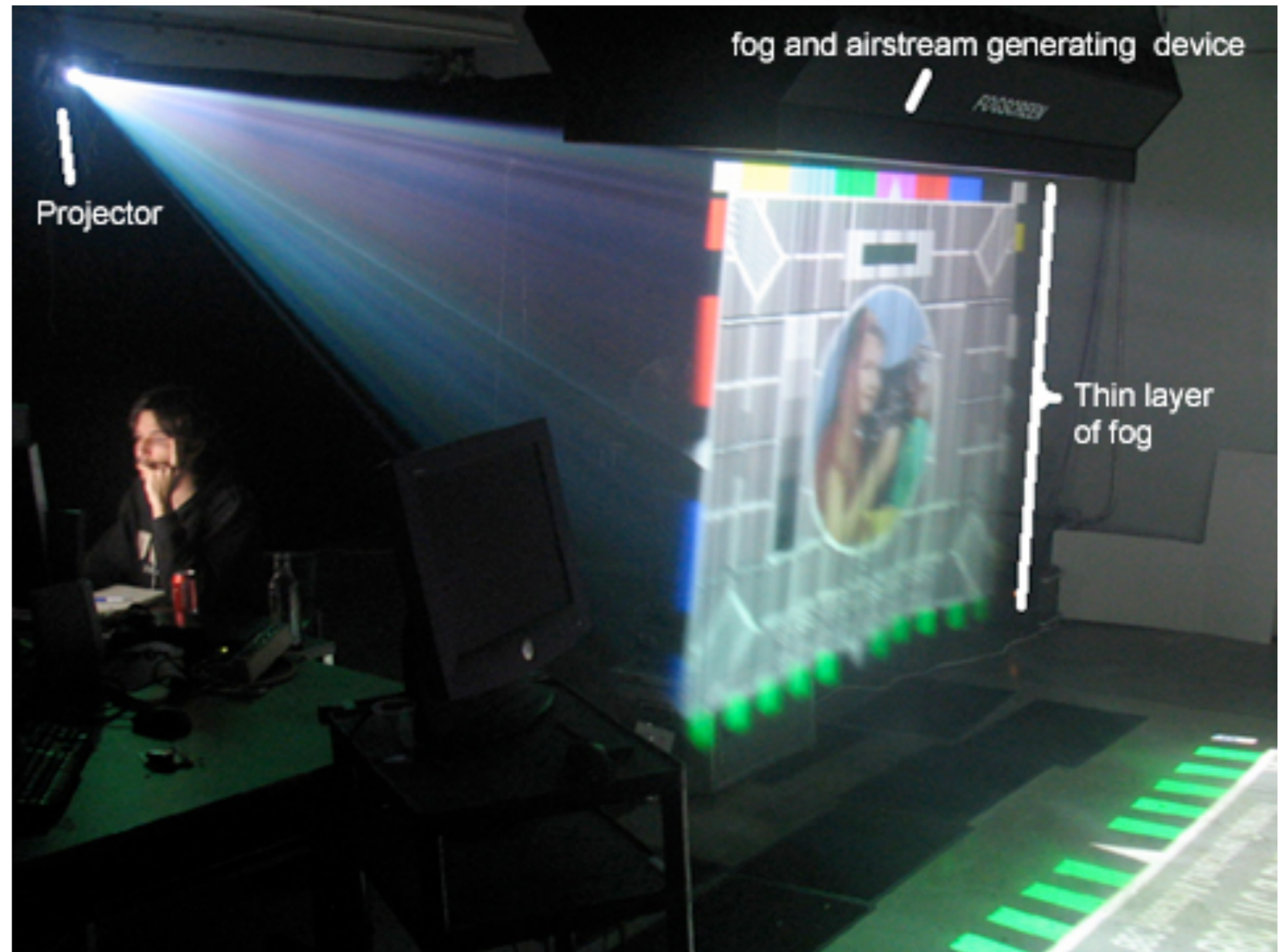

FogScreen (2)

- Fog sandwiched between airstreams
- Immaterial → user can reach or walk through unhindered

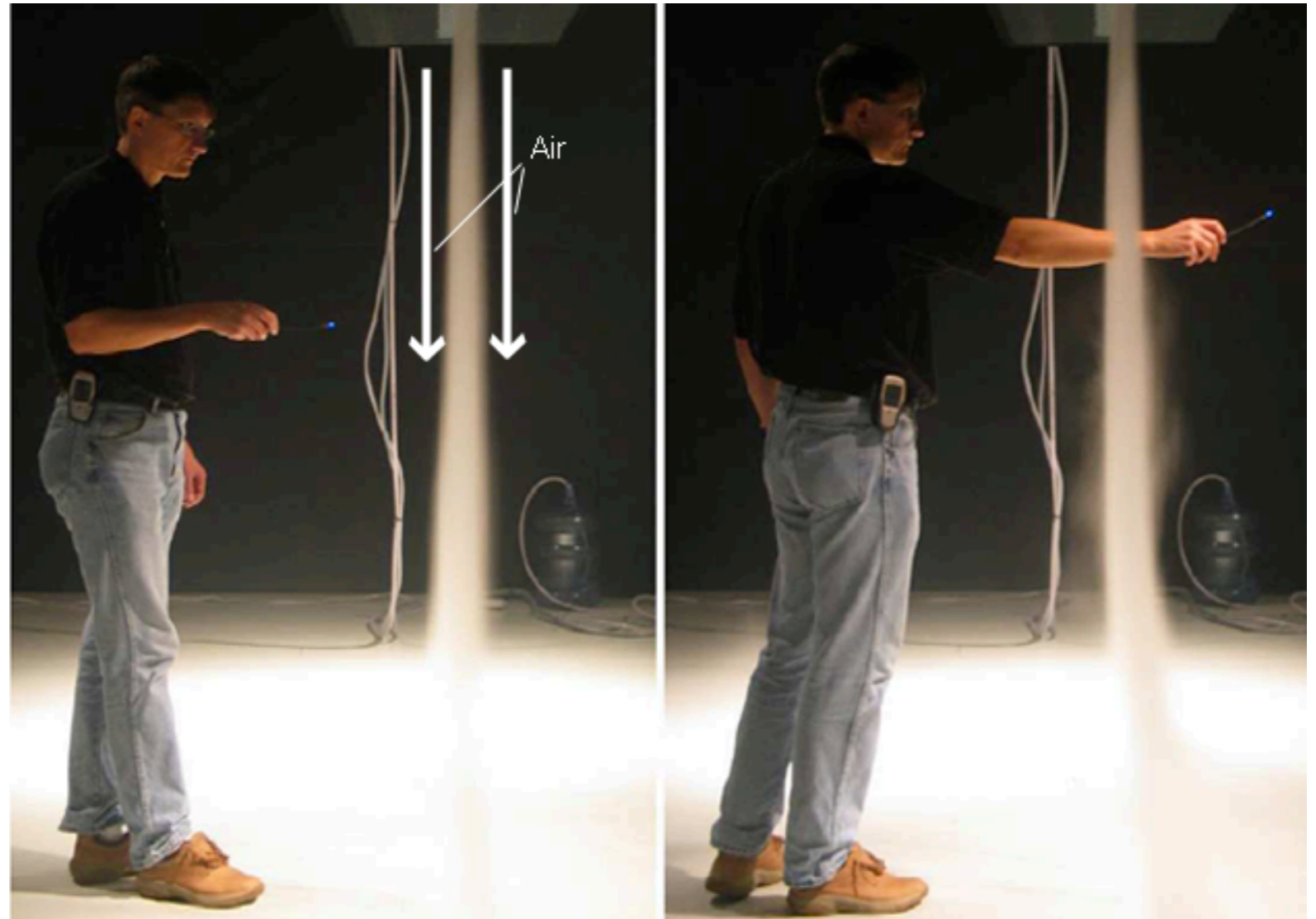

FogScreen (3)

- Technical Details
 - First introduced at UIST 2004
 - So far only 9 FogScreens in the world
 - Price: 100k \$
 - Weight: around 100 kg
 - Needs: 10L/h, 300W



FogScreen (4)

■ Pseudo 3D

- Double sided projection possible
- E.g. opposite views of the same scene

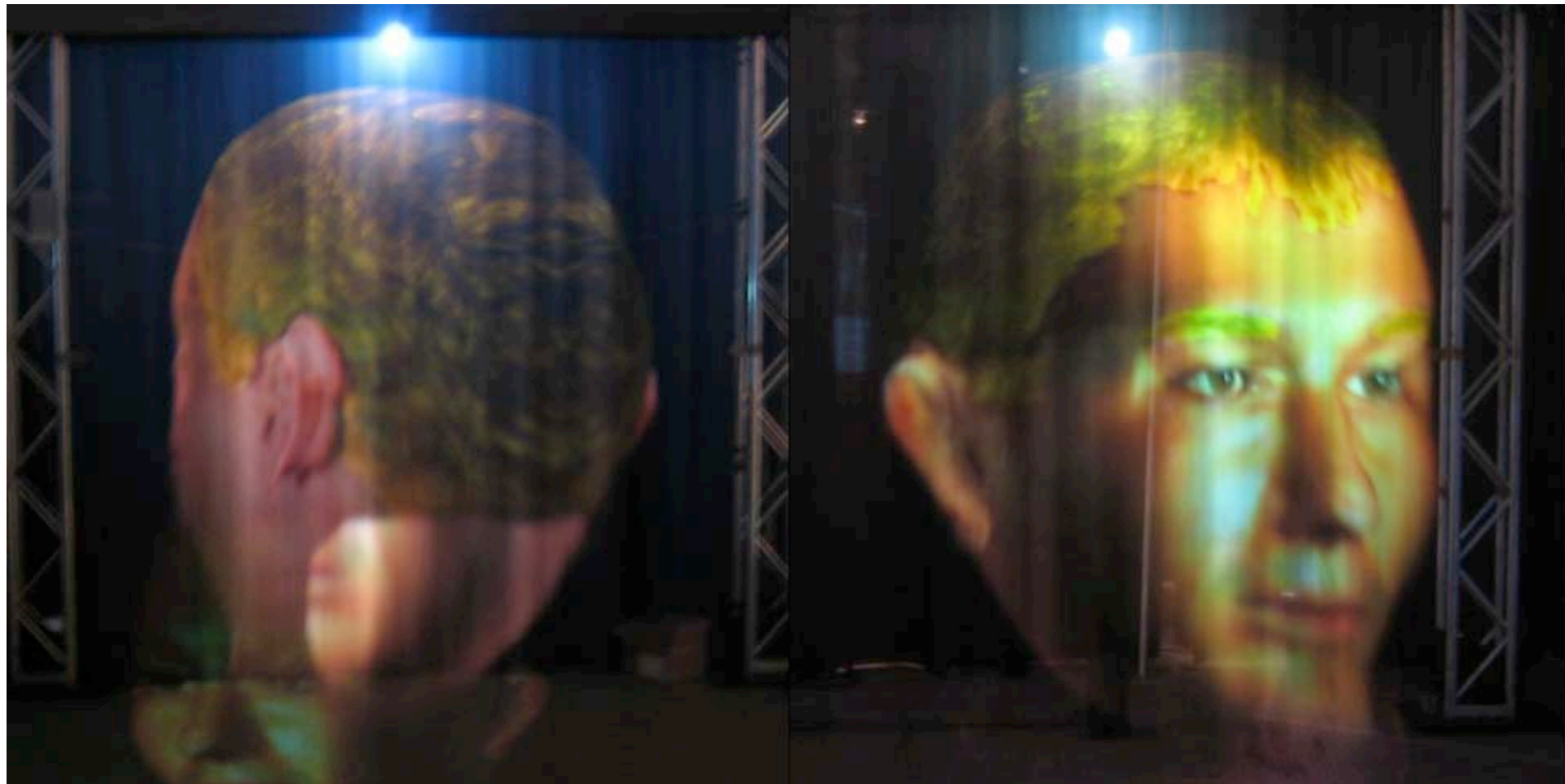

FogScreen(4)

- Pseudo 3D – HeadTracking (S. DiVerdi)
 - Tracking the users Head
 - Input used for adapting the frustum for accurate perspective rendering

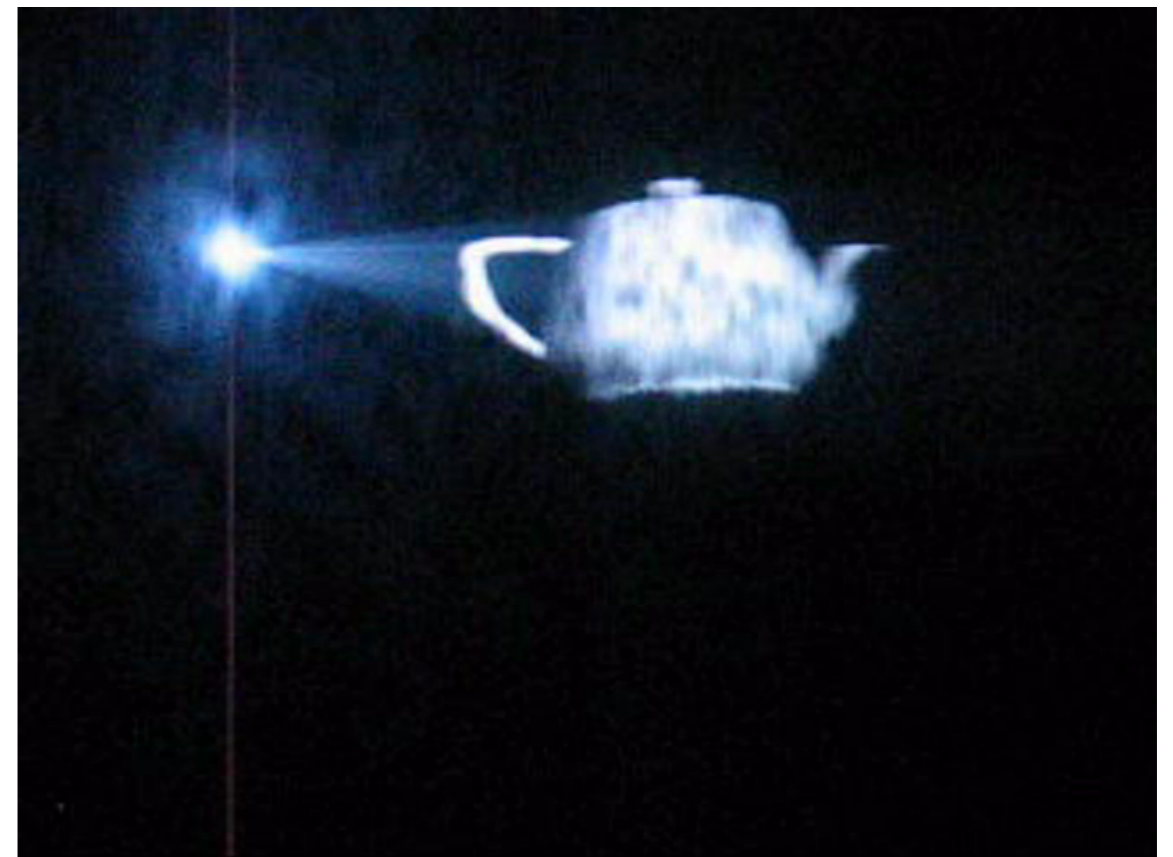
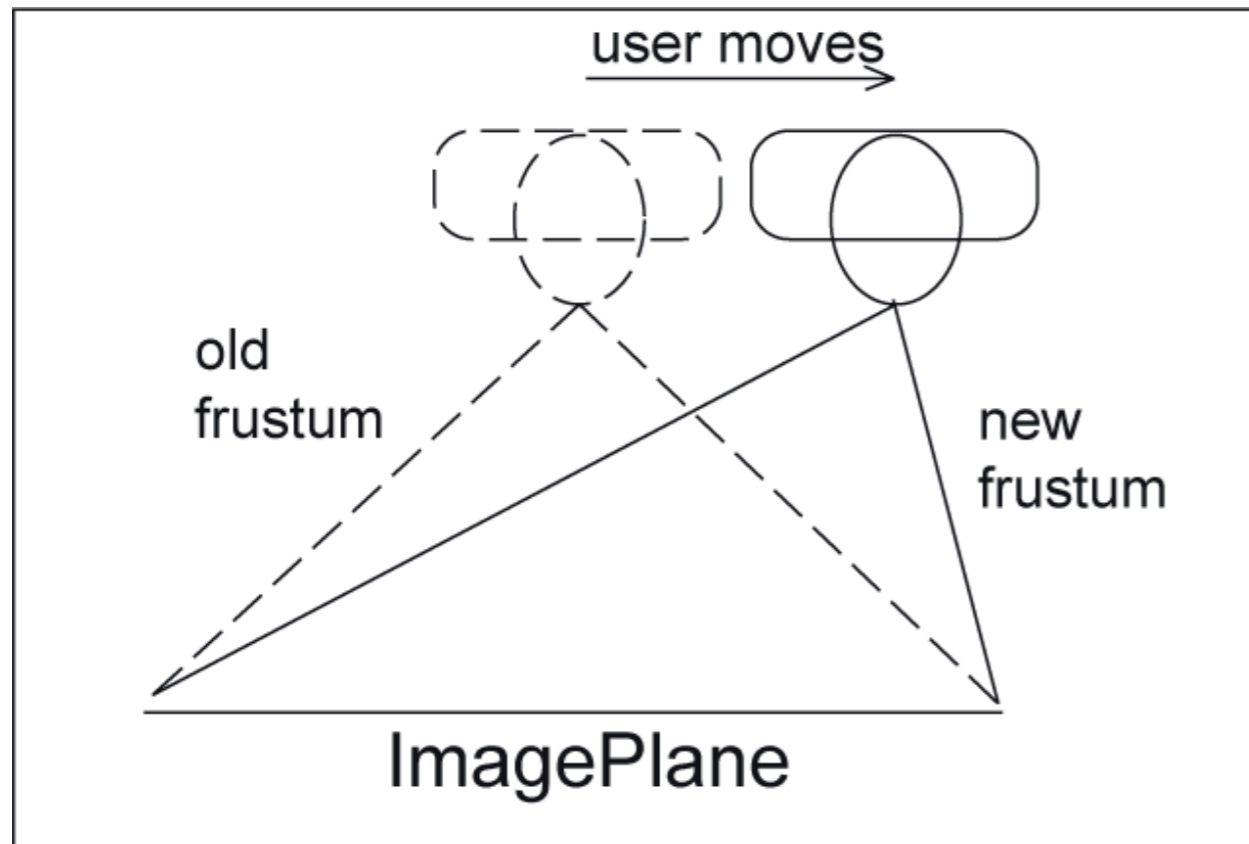

FogScreen (5)

■ Interaction

- Laser Range Scanner
- UltraSound
- Infrared LED Tracking

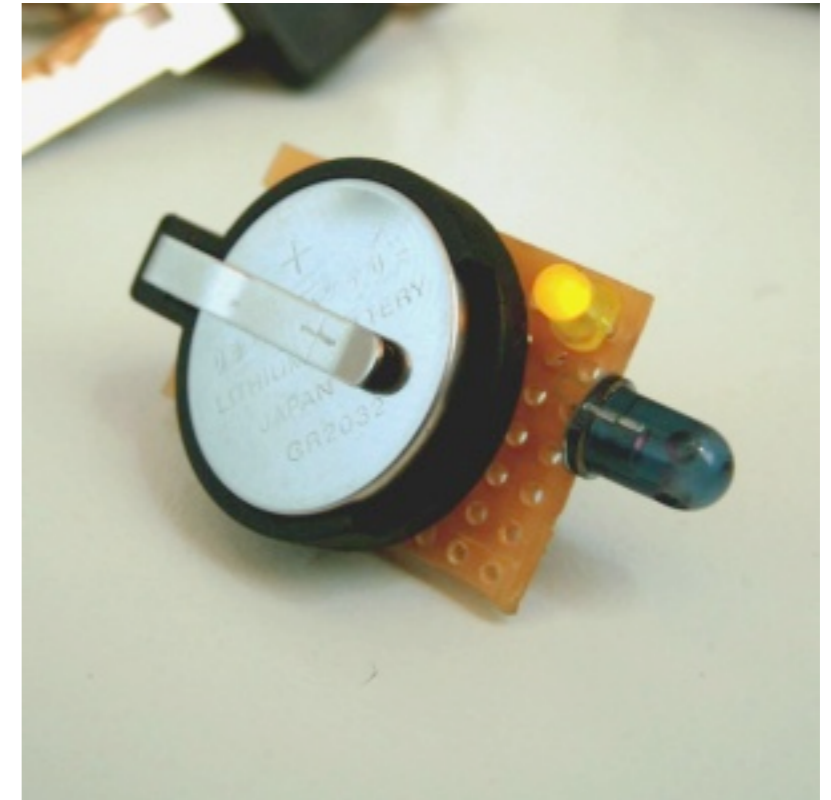

FogScreen(6)

- Interaction – Setup: either
 - LRF attached to the FogScreen corner OR
 - UltraSonic Device attached to FogScreen corner OR
 - Infrared Cameras in the corners of the room

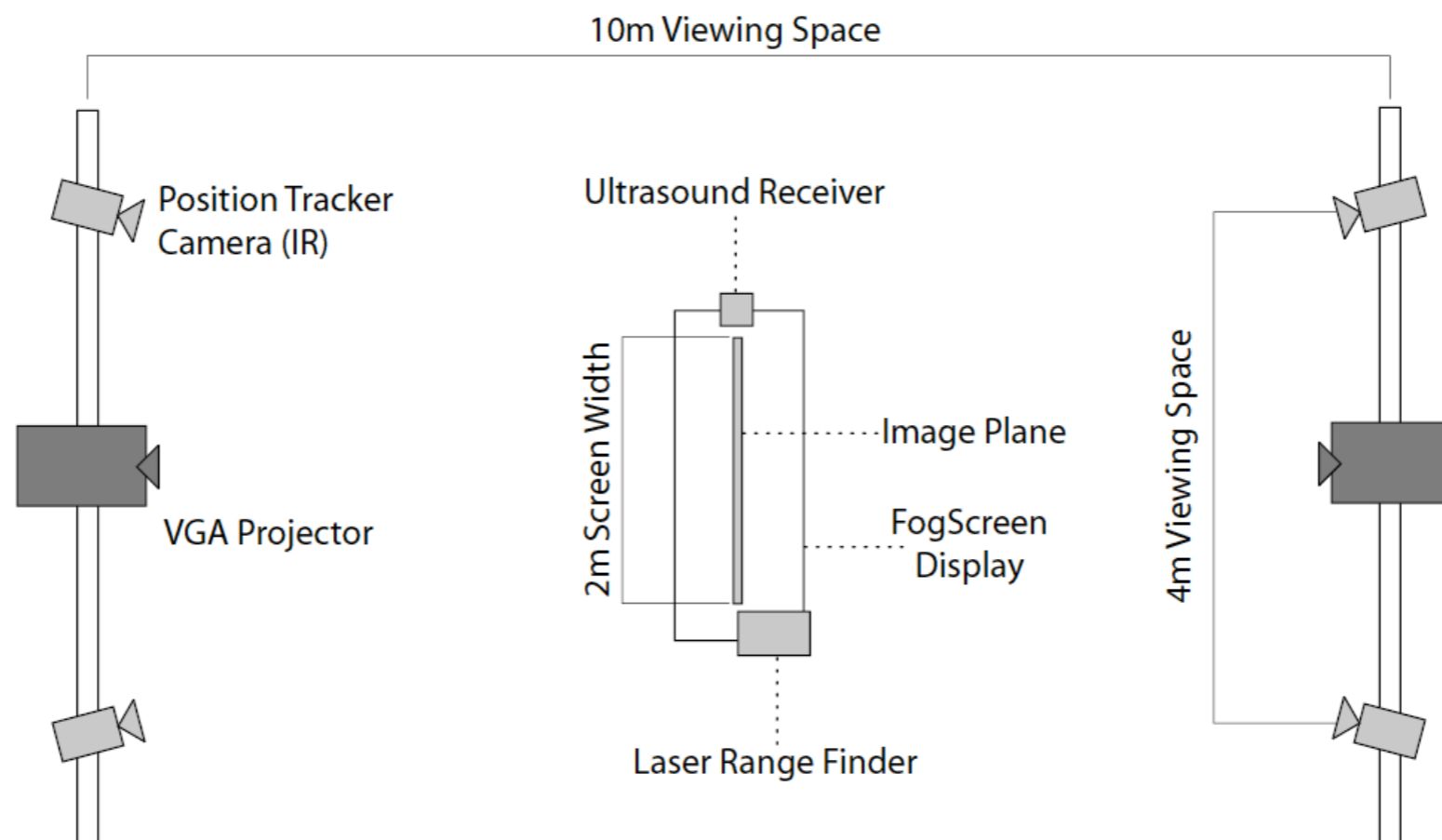

Resources

- <http://www.fogscreen.com/>
- <http://ilab.cs.ucsb.edu/projects/ismo/fogscreen.html>
- <http://www.worldviz.com/ppt/index.html>
- <http://www.robosoft.fr/SHEET/02Local/1004SickLMS200/SickLMS200.html>
- <http://www.e-beam.com/>

Auditory Displays

Spatial Audio Cues

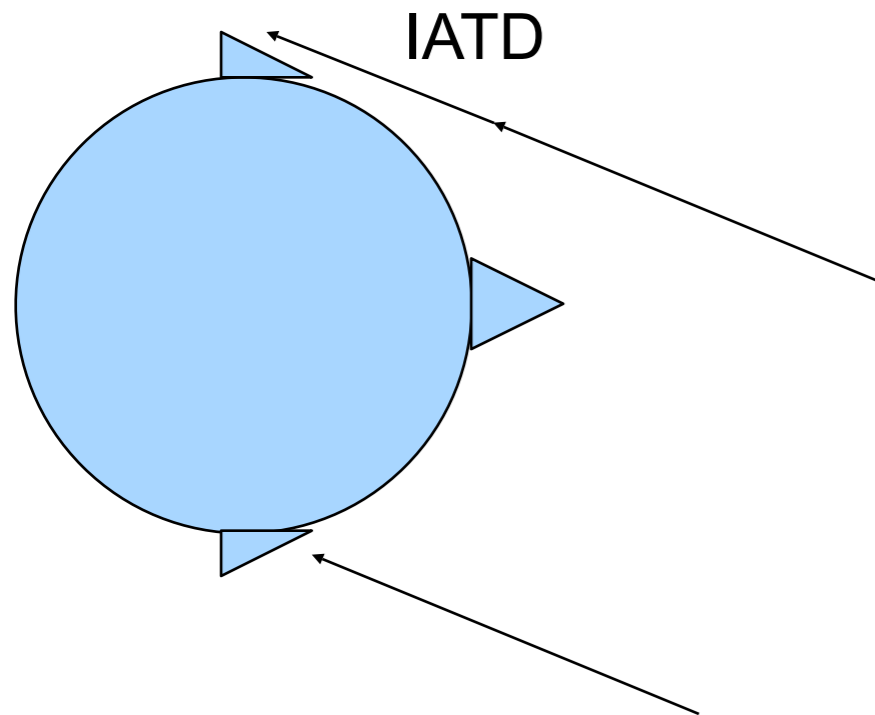

- IATD: Interaural time difference: sound arrives at the ears at different times
- IAD: Interaural intensity difference: sound arrives with different volume
- Spectral difference; the shape of the head and ear cause a different spectral transmission to both ears. This can be expressed in Head-Related Transfer Functions (HRTF)

Tracked head phones

[e.g., <http://listen.imk.fraunhofer.de/>]

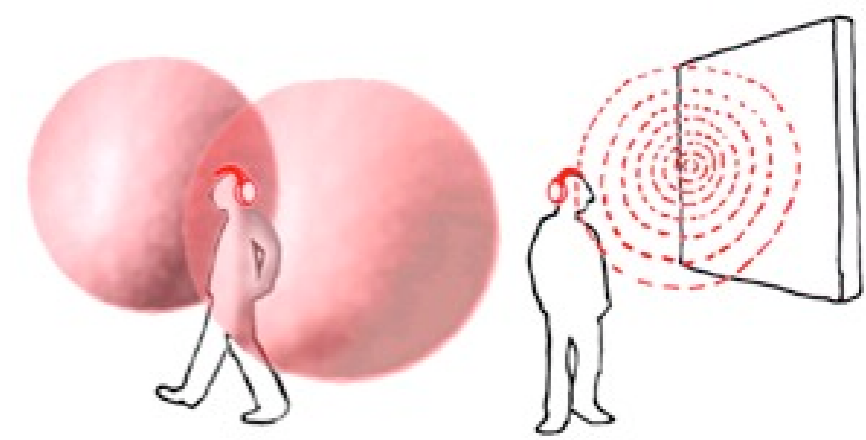

Vector Based Amplitude Panning

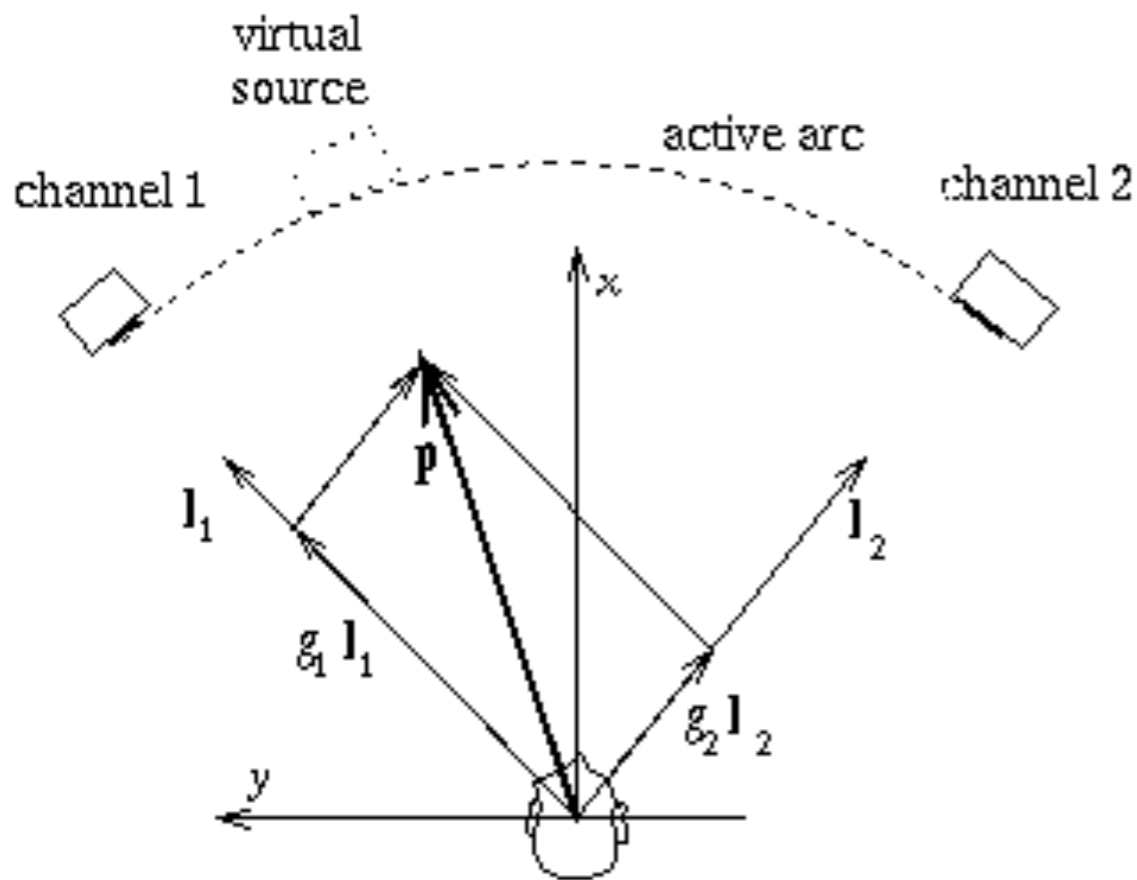

$$\underline{p} = g_1 l_1 + g_2 l_2 = Lg$$

$$g = p^T L^{-1}$$

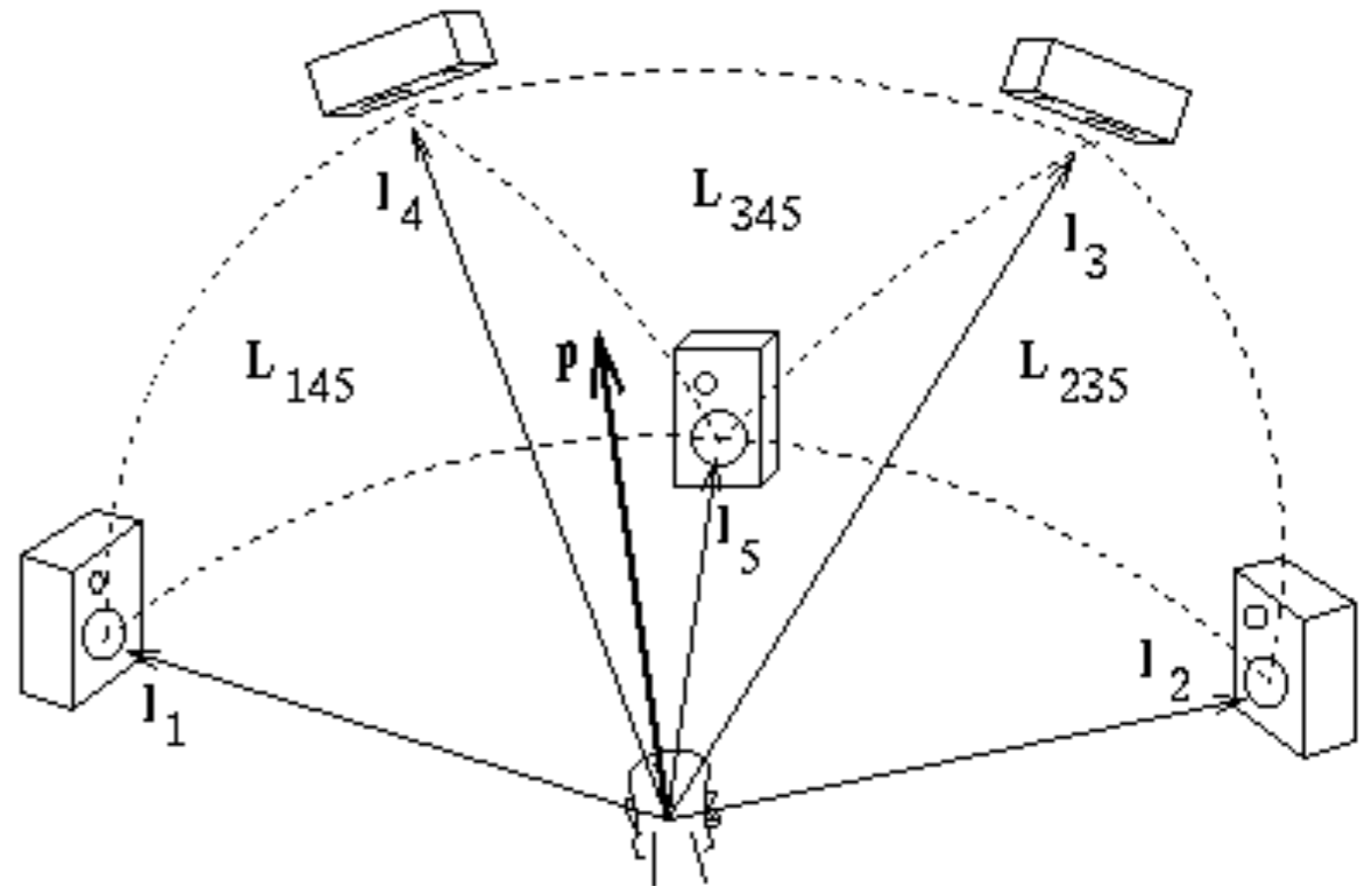

$$\underline{p} = g_1 l_1 + g_2 l_2 + g_3 l_3 = Lg$$

$$g = L^{-1} p^T$$

Wave field synthesis



primary
source



virtual
source

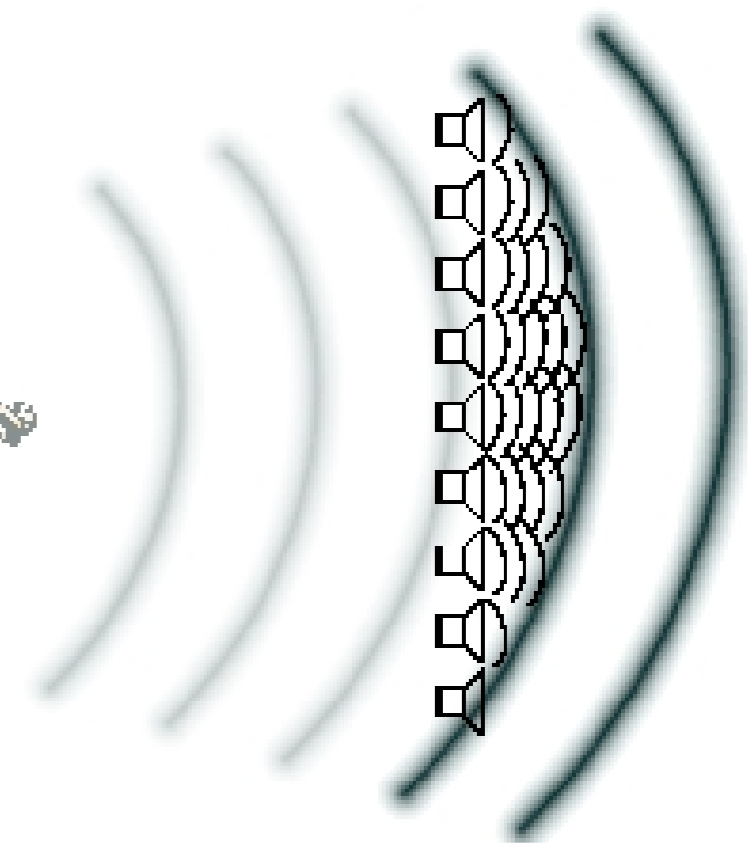

- Huygenic principle (1678): "every point in a wavefront can be seen as the origin of elementary waves, that propagate with the same velocity and wavelength as the original waves. The enveloping of all elementary waves constitutes the new wavefront."