

Interaction techniques for AR

Vorlesung „Augmented Reality“

Prof. Dr. Andreas Butz

WS 2006/07

Ein Generisches AR-System

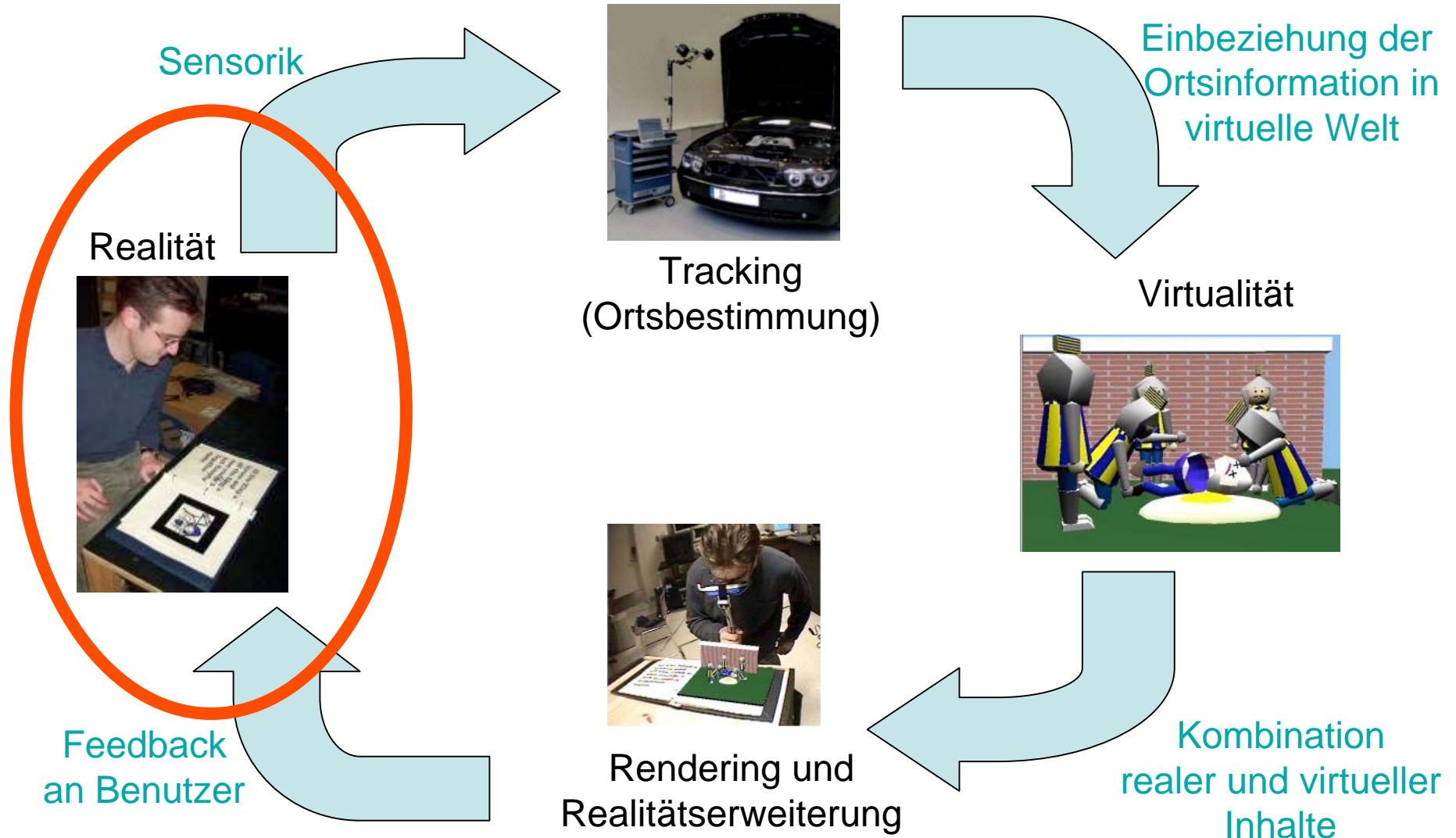

Interaction techniques for AR

- Interaction techniques borrowed from VR
 - Virtual Object selection & manipulation
 - 3D widgets, tools, wands,...
- Interaction with physical objects
 - Examples by Sony CSL/Rekimoto
 - Examples from TU Vienna/Studierstube

Reference frames for virtual objects

- **Screen-stabilized:** always in the same screen position or HMD position
 - Good for text, menus, status displays
- **Body-stabilized:** always in the same area around the body
 - Example: tool palettes
- **World-stabilized:** always in the same place in the real world
 - Example: labels on physical objects
- **Bound to a tracker target or marker**
 - Examples: see AR Praktikum ;-)

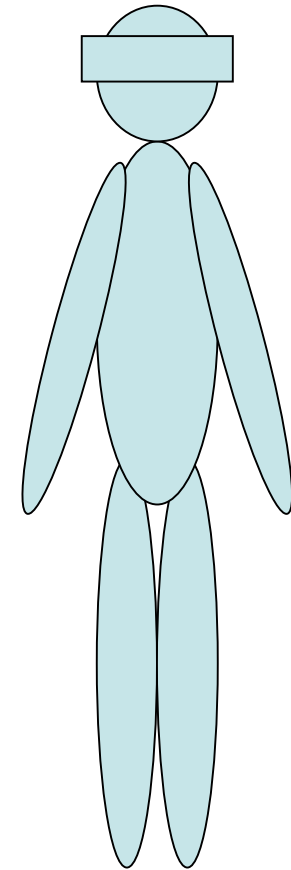
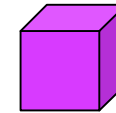

Dimensionalities of interaction

Medium → Content	2D	3D
2D	2D Screen interfaces, windows	PIP, billboards, screen stabilized
3D	Fishtank VR	Full 3D interaction in AR & VR

3D mouse: example from Studierstube



[Video](#)

FingARtips [\[Buchmann et al. 2004\]](#)

- Glove with 3 AR Markers
- Interaction by gestures
 - Grab objects
 - Move grabbed objects
 - Let objects go
 - Scale objects
- Application: urban planning

[Video](#)

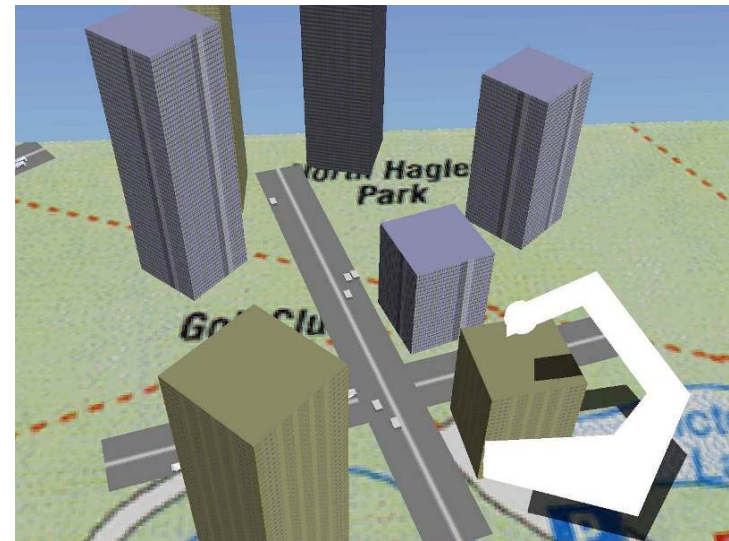
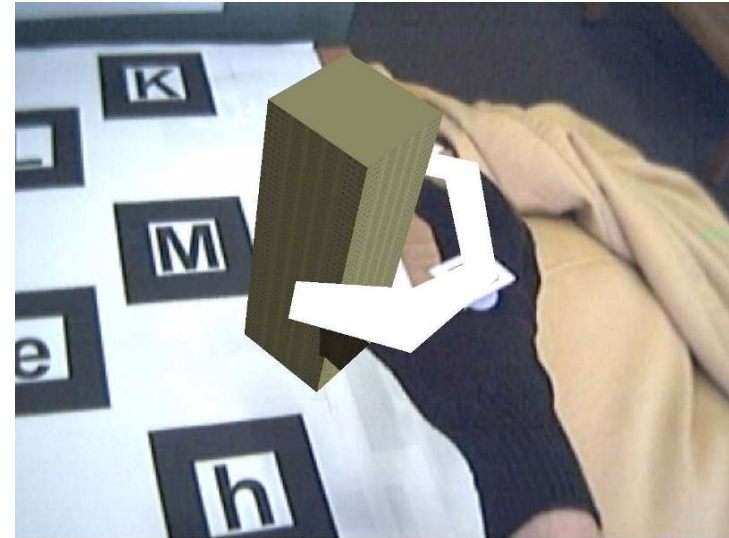

The Tinmith glove-based interface

[\[Piekariski, 2002\]](#)

- Two gloves equipped with:
 - ARToolkit Markers for position
 - Contacts in the finger tips
- Connecting the fingers can
 - Choose from a menu
 - Select a manipulation mode
- Direct manip. of virtual objects
- Two-handed manipulation



[Video through the HMD](#)

[Video from outside](#)

The Magic Book [\[Billinghamurst 2000\]](#)

- Flipping through a physical book
 - Pages contain markers
 - On the pages appear virtual objects
-
- New version:
[BlackMagic](#)

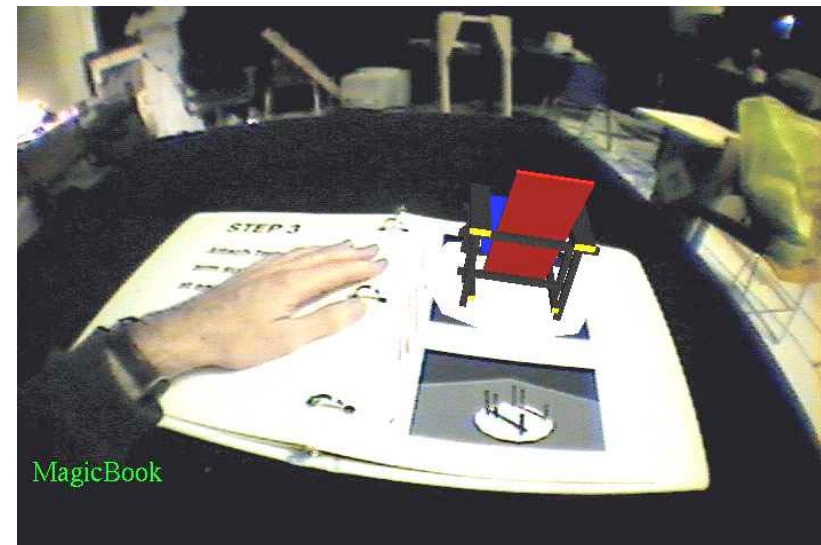

3D magic lenses [\[Looser 2004\]](#)

- Metaphor: magnifying glass
- Can show different visualizations of a virtual object

[Video](#)

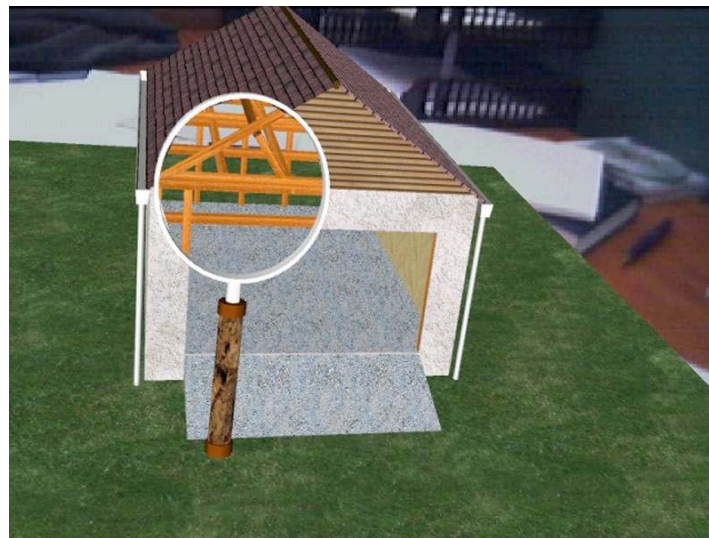
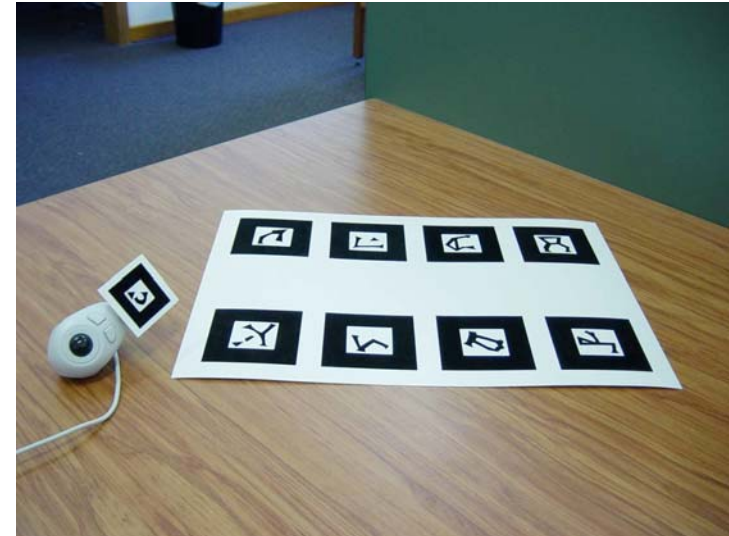

World in Miniature

- Small 3D model of the environment
- Can be turned and viewed from all directions
- Can be used for selection of remote objects

- Example [video](#) taken from the Signpost system (Studierstube)

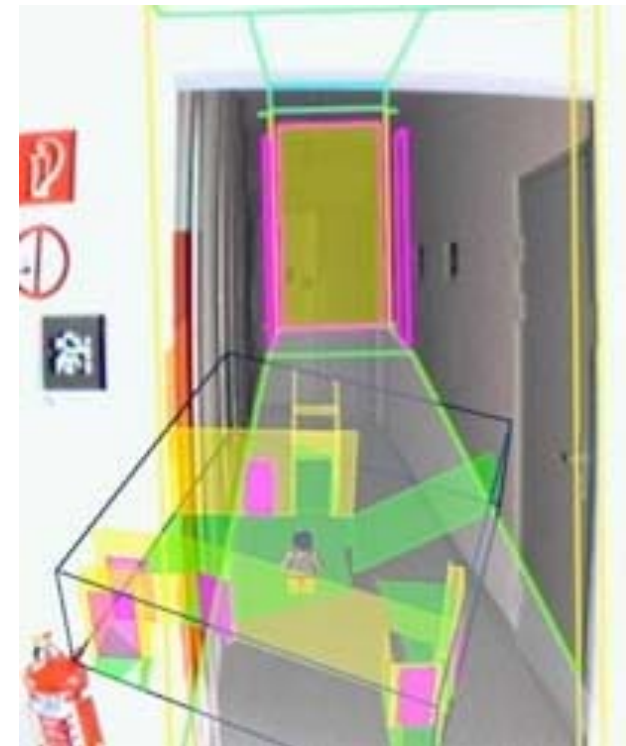

X-ray vision [Bane & Hoellerer, ISMAR 2004]



Navicam: The world through the computer

[Rekimoto & Nagao, UIST 1995]

- Video see-through with a handheld device
- Marker recognition
- Annotation of real world:
 - New journals on a book shelf
 - Appointments on a calendar
 - ToDos on a pin board
 - Labels on a door
 - Navigation signs in the environment

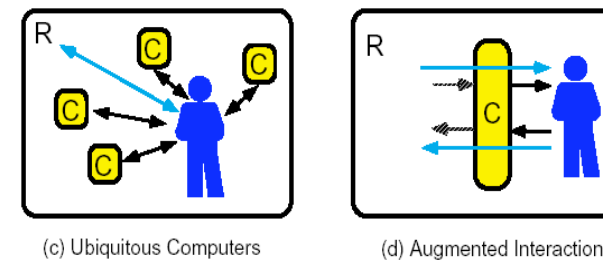
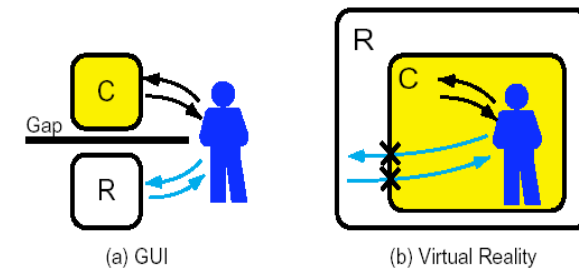
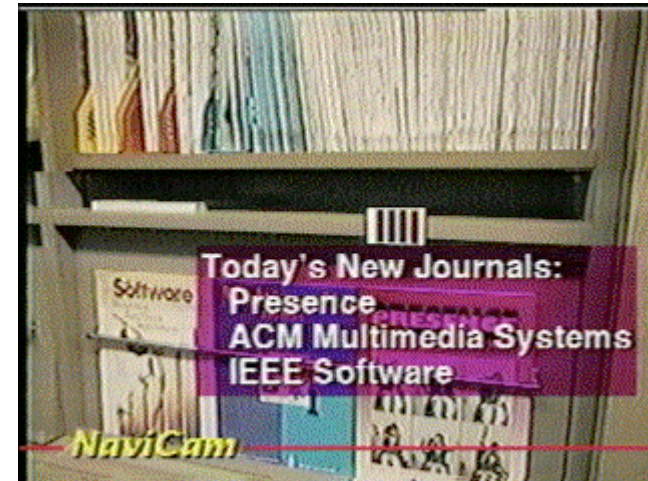

C Computer World ↔ Human - Computer Interaction
R Real World ⇄ Human - Real World Interaction
R Real World - Computer Interaction

Video

Augmented Surfaces

Jun Rekimoto and Masanori Saitoh, CHI'99

- Combination of mobile devices and projection surfaces
- Interaction techniques:
 - hyperdragging
 - pick-and-drop
 - pick-and-beam
 - digital attachment
 - interaction objects for tangible interaction
 - Camera-based acquisition of images
 - Selection from physical catalogues

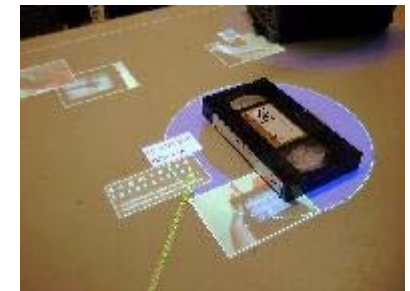
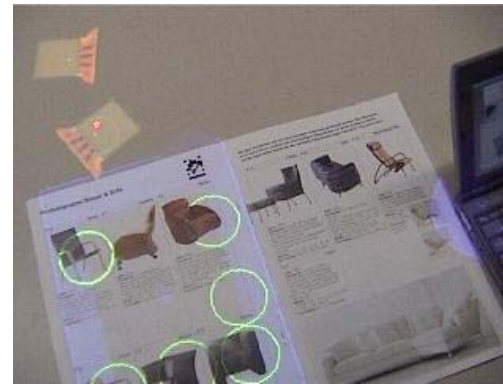

Video

Tangible Augmented Reality for Computer Games [\[Ulbricht 2002\]](#)

[Video](#)

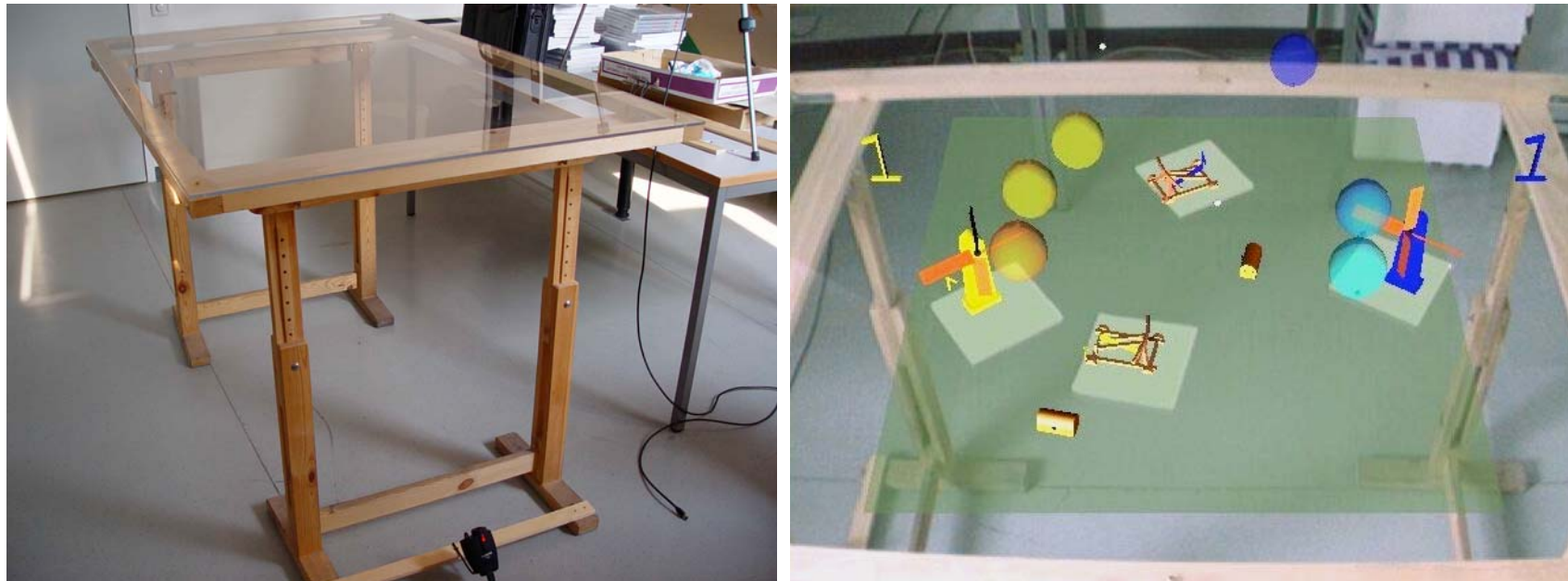

- Idea: use physical objects (Markers) as a handle for virtual objects
 - Feels like direct manipulation
 - Easy to implement

Studierstube: The Personal Interaction Panel (PIP)

[[Szalavari & Gervautz, 1997](#)]

- Two-handed interaction
- Metaphor: slate & crayon
- Manipulation of two physical objects
 - Feels „real“
 - Weight of the objects
 - Acting on a surface
 - Familiar interaction
 - Feeling of privacy
 - Easy to attach tracking
 - Arbitrary graphical overlays

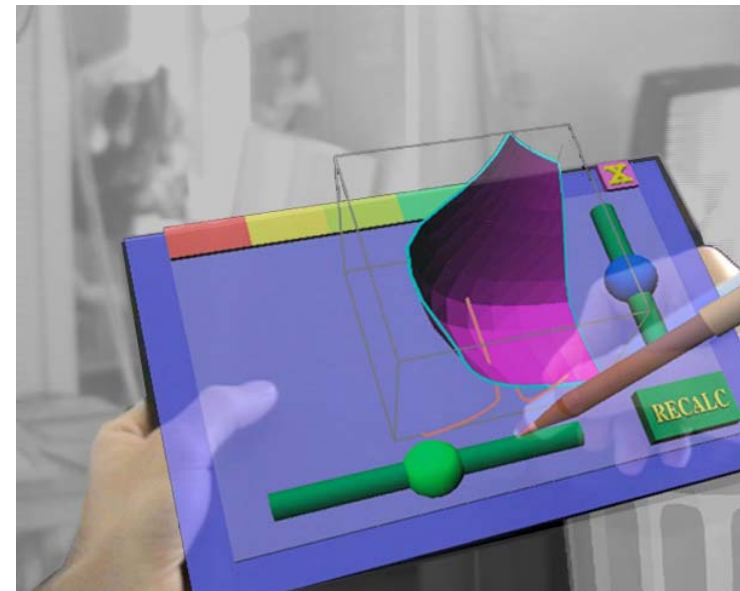

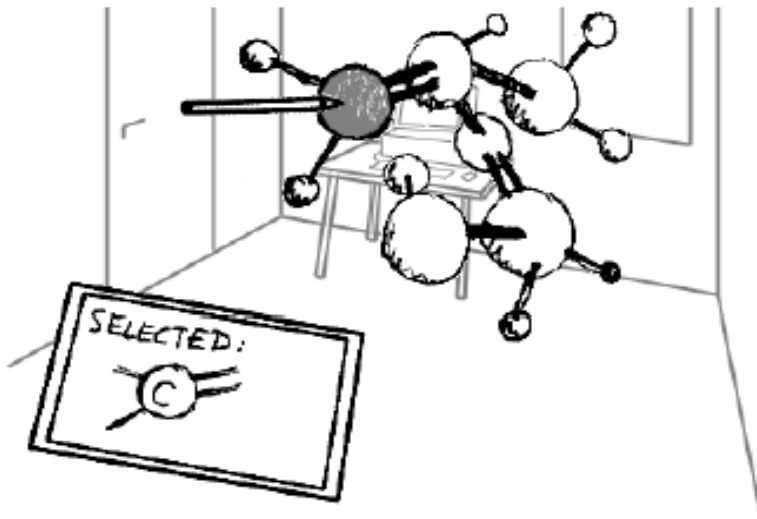

Figure 1. *Direct selection of objects by inserting the pen into the “floating” model (background illustrates augmentation)*

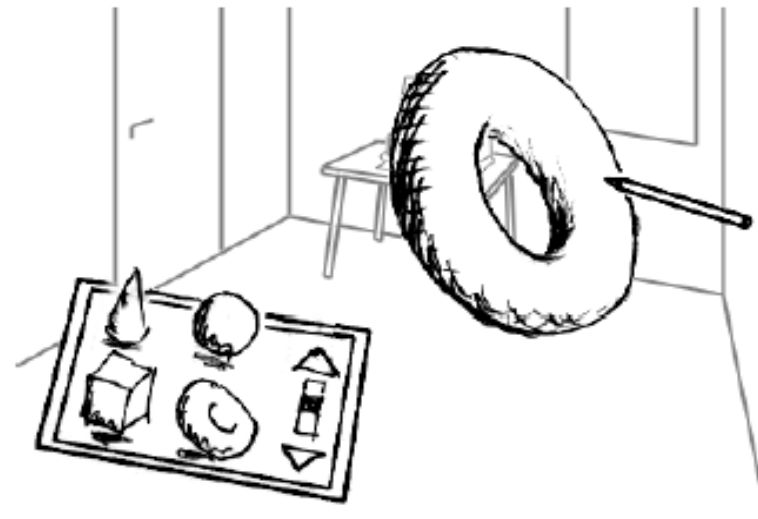

Figure 2. *“Drag & Drop” objects from a clipboard in 3 dimensions*

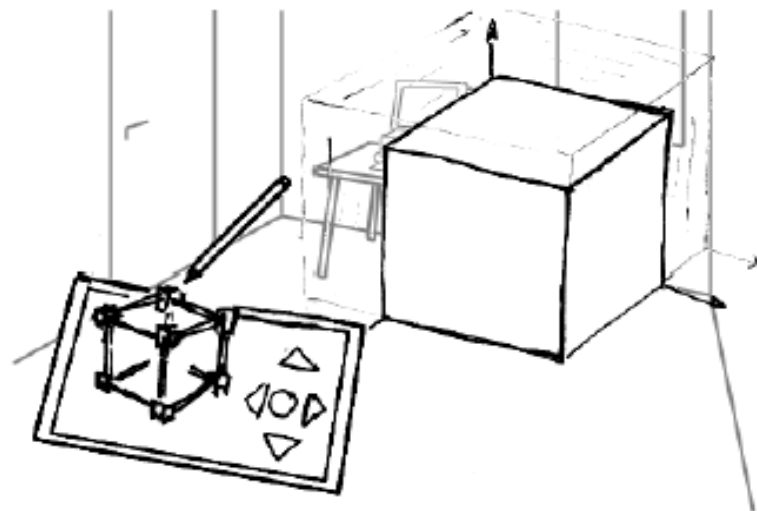

Figure 3. *In addition to direct manipulation, widgets can be used for exact scaling ...*

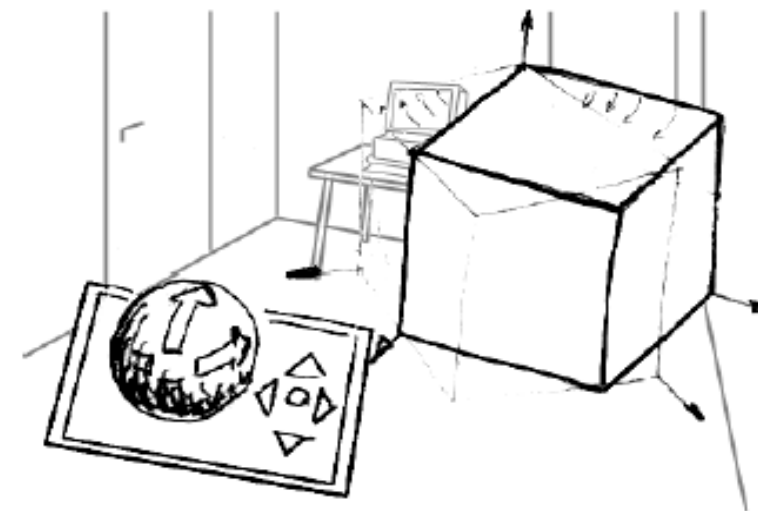

Figure 4. *... or rotation of objects*



Figure 11. For scientific visualization the PIP can be used to specify and edit cutting planes ...

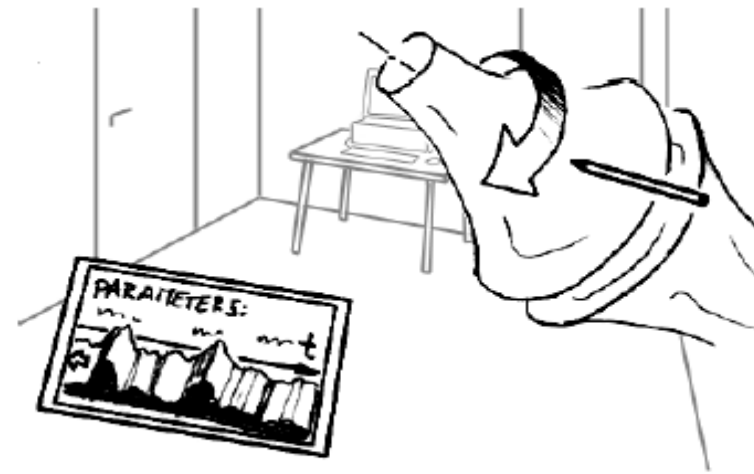

Figure 12. ... or measure simulated parameters at given locations and show instantly their evolution as 3D-graph on the panel

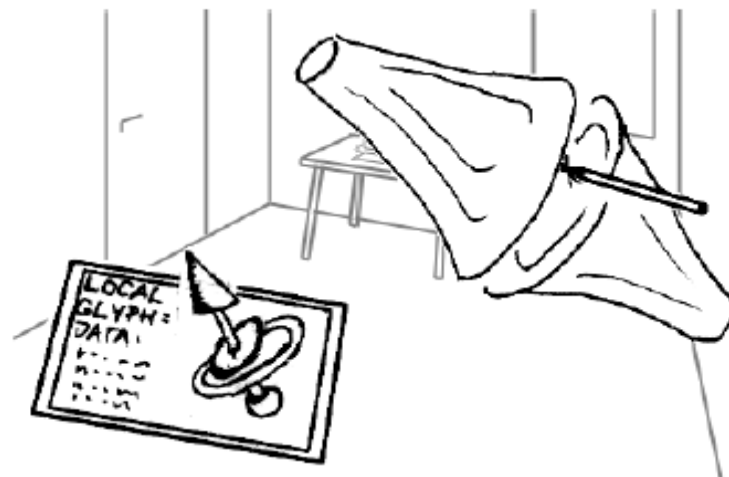

Figure 13. Multidimensional parameters at any point are shown using glyphs on the PIP or directly at the measuring point

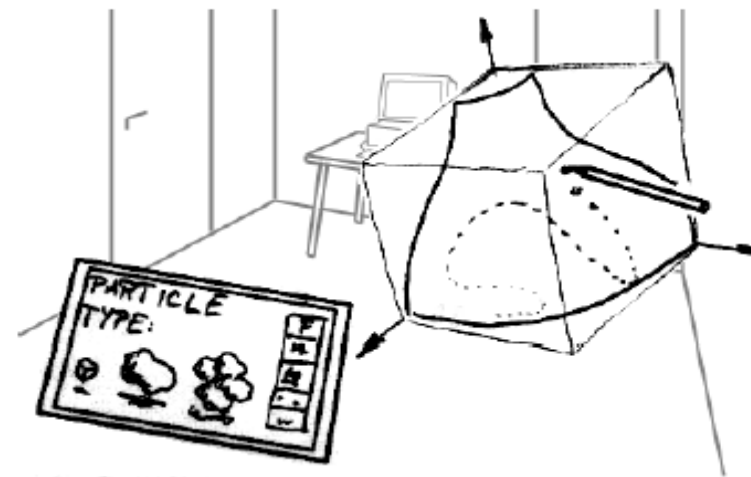

Figure 14. Introducing particles directly in an ongoing dynamic simulation should be very intuitive

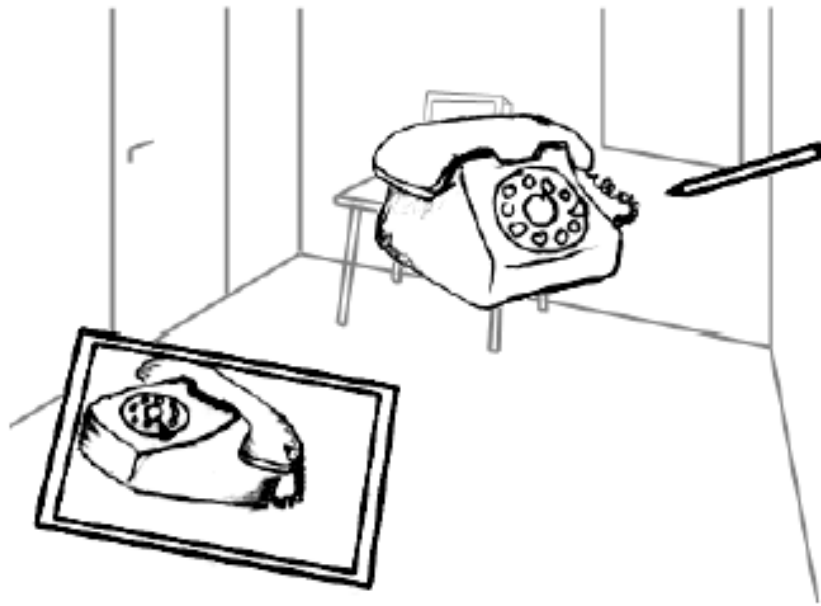

Figure 6. *Camera positioning with the pen*

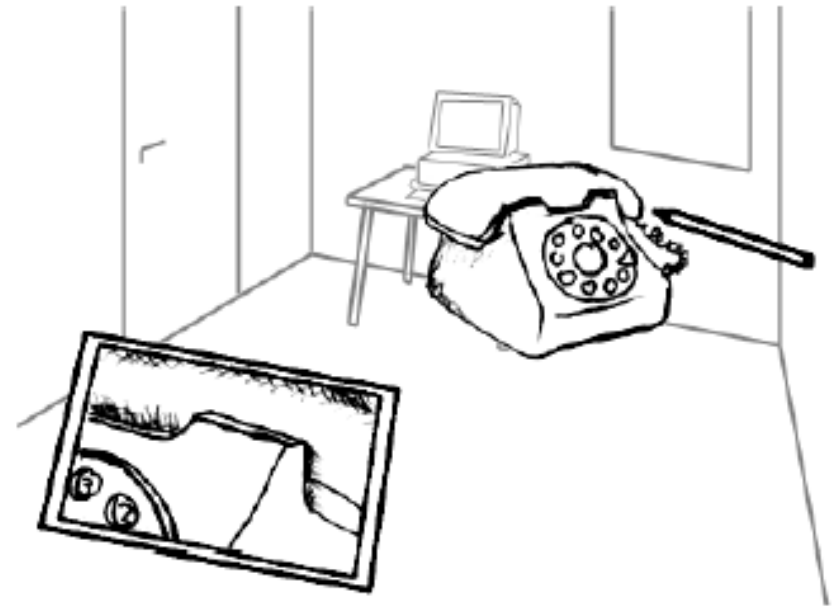
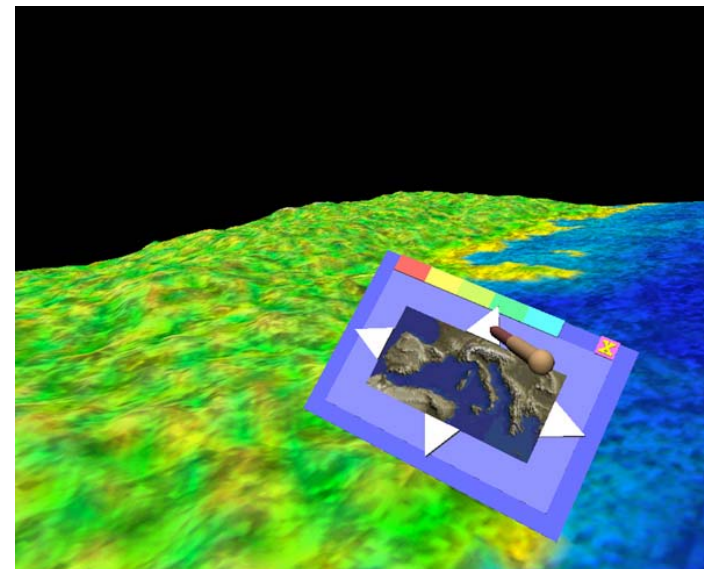
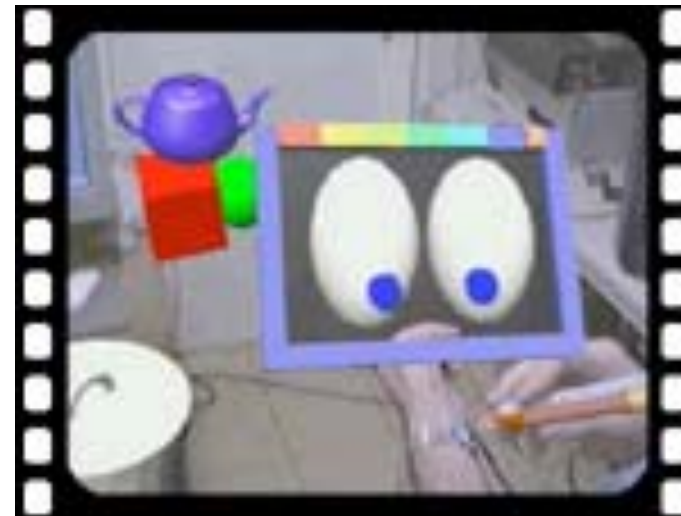
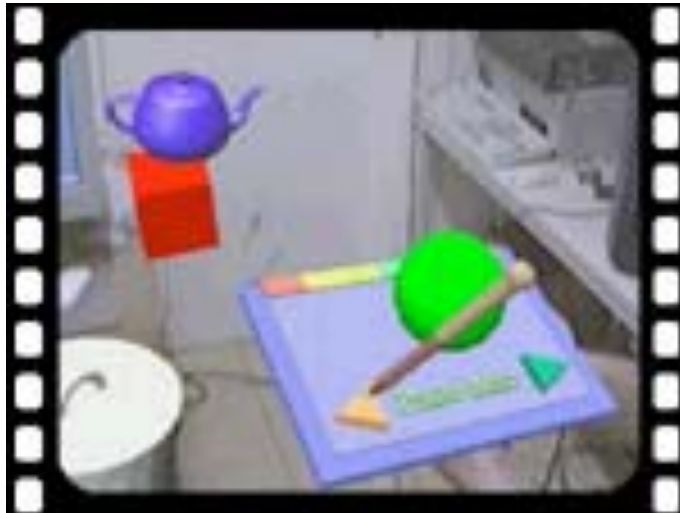

Figure 7. *Enlarged view of a detail*



Studierstube: The Personal Interaction Panel (PIP)

[[Szalavari & Gervautz, 1997](#)]



The Virtual Dressmaker [\[Keckeisen 2003\]](#)

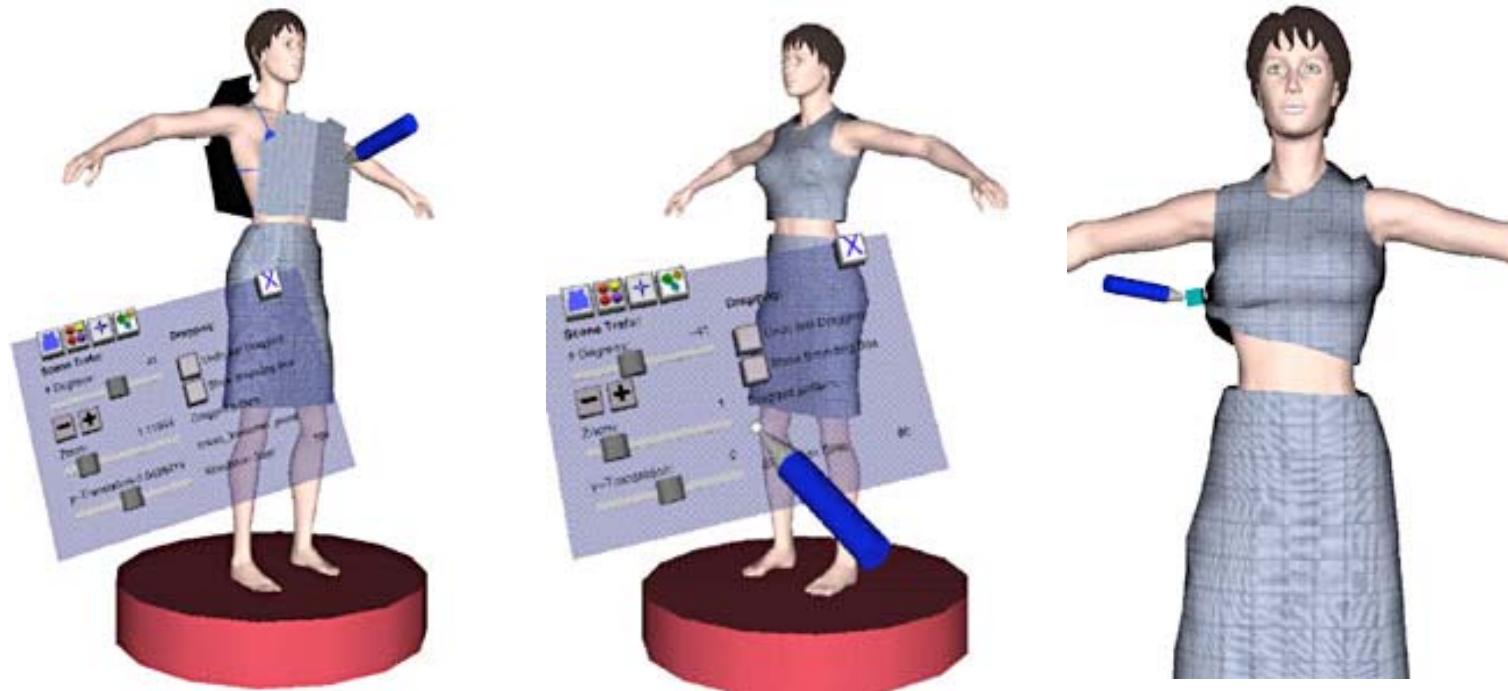

- PIP as a palette and pen as a manipulation tool
- Physical simulation of clothing fabric [Video](#)
 - Interact with the fabric directly
 - Use 3D widgets to manipulate whole model

Studierstube: the iOrb [\[Reitmayr et al. 2005\]](#)

- One-handed spatial input and command
 - 3DOF orientation tracker
 - Switch to trigger actions
- Easy to build
- Easy to use
- Physical object
 - Weight
 - Inertia
 - Elasticity

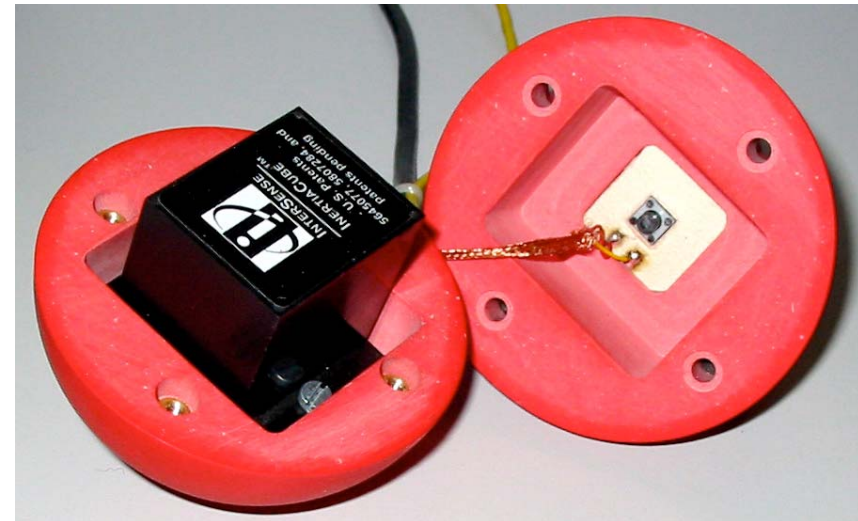
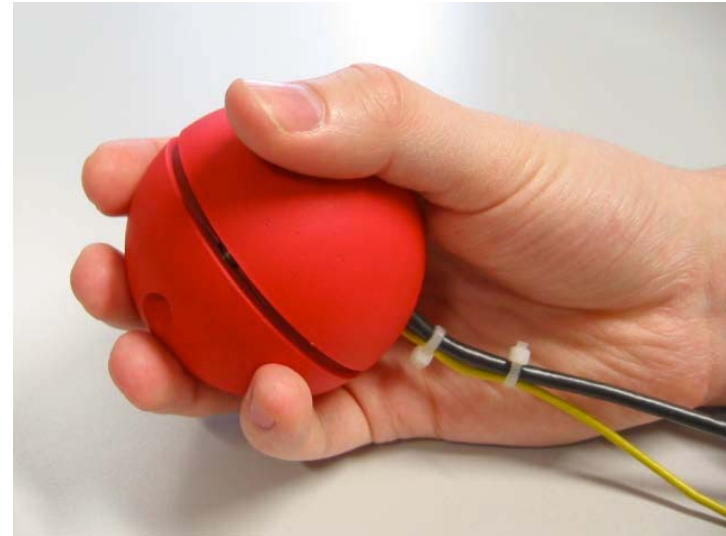

Studierstube: the iOrb [\[Reitmayr et al. 2005\]](#)

- Widgets for visual feedback
 - Constrained to one axis (a+b+d)
 - Using 3 axes (c)
- See [Video](#)

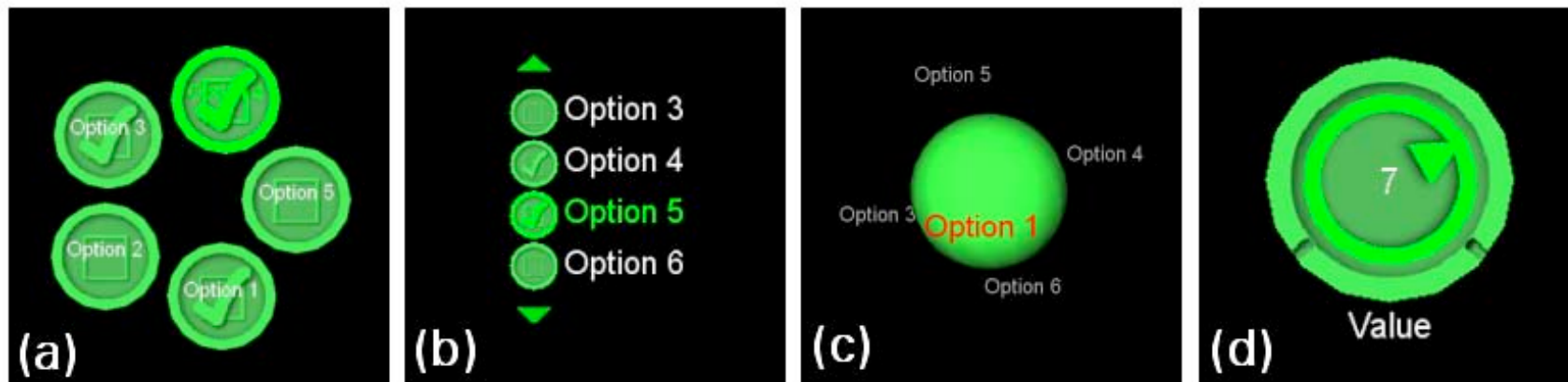
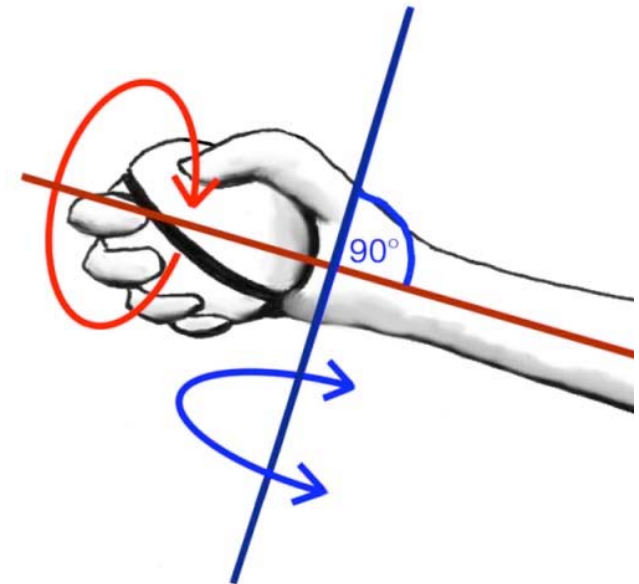

The Designer's Outpost

[Klemmer et al. Uist 2001]

- Manipulation of physical sticky notes on a smartboard
 - Augmentation by back projection
 - Interaction through smartboard
 - Additional cameras
-
- Task: design the structure of a web site
 - Keep the physical process
 - Augment it by technology

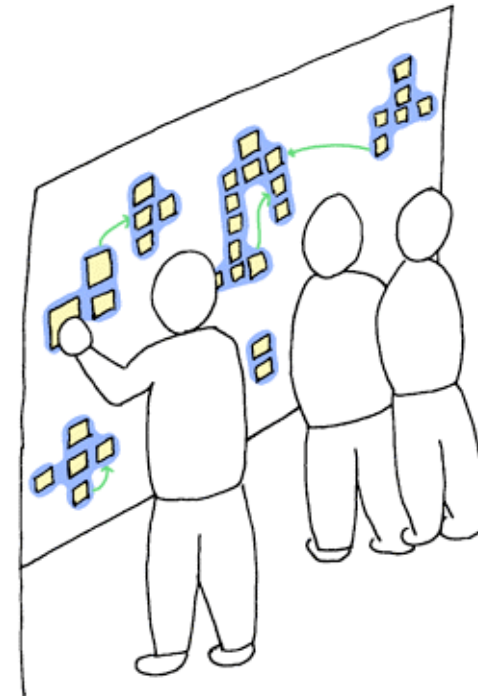

The Designer's Outpost: Interaction Techniques

