

Interaction Design

Chapter 12 (July 17, 2013, 9am-12pm):
Simplicity and Graphical User Interface Design

Part One

"Great design is as much about prospecting in the past as it is about inventing the future."

Bill Buxton

Design and Simplicity

- Bauhaus: History and Directors
- Bauhaus: Structure and Products
- From Bauhaus to Braun



Bauhaus

http://www.portal-dessau.de/uploads/pics/Bauhaus_TM_2010_2.JPG

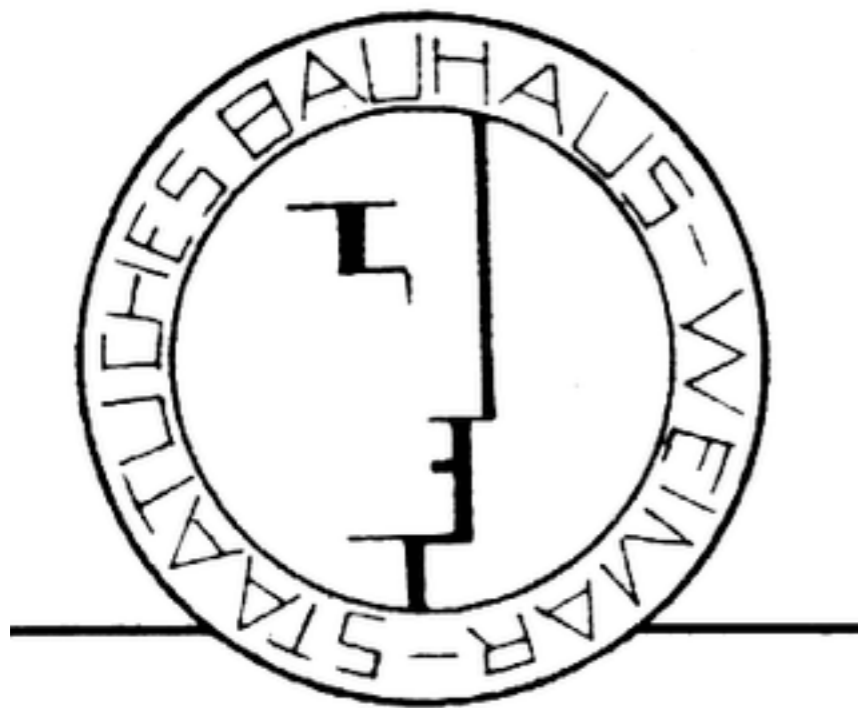

<http://www.flickr.com/photos/scoobyfoo/268308263/sizes/l/in/photostream/>

Key Dates:

founded 1919 in Weimar
closed down 1933 in Berlin

Key People - 3 Directors:

[1] Walter Gropius (1919-1928)

[2] Hannes Meyer (1928-1930)

[3] Ludwig Mies van der Rohe (1930-1933)

[1]



[2]



[3]



source: [7]

http://www.stylepark.com/db-images/cms/designer/img/miesvanderrohe_320_336-1.jpg

http://einestages.spiegel.de/hund-images/2009/03/30/59/3d98cebcb31abdbc318ed82e888903d6_image_document_large_featured_borderless.jpg

**Art and technology - a new entity.
Walter Gropius**



**The investigation of human needs should
be based on science - not formalism.
Hannes Meyer**



**God is in the details.
Ludwig Mies van der Rohe**



http://www.stylepark.com/db-images/cms/designer/img/miesvanderrohe_320_336-1.jpg

http://einestages.spiegel.de/hund-images/2009/03/30/59/3d98cebcb31abdbc318ed82e888903d6_image_document_large_featured_borderless.jpg

Design and Simplicity

- Bauhaus: History and Directors
- Bauhaus: Structure and Products
- From Bauhaus to Braun



Pre-Course



Prototyping Design

BAUHAUS

Hrsg.
Jeannine Fiedler
Peter Feierabend



Basic Shapes

h.f.ullmann

www.kunstbuch-shop.de

source: [8]

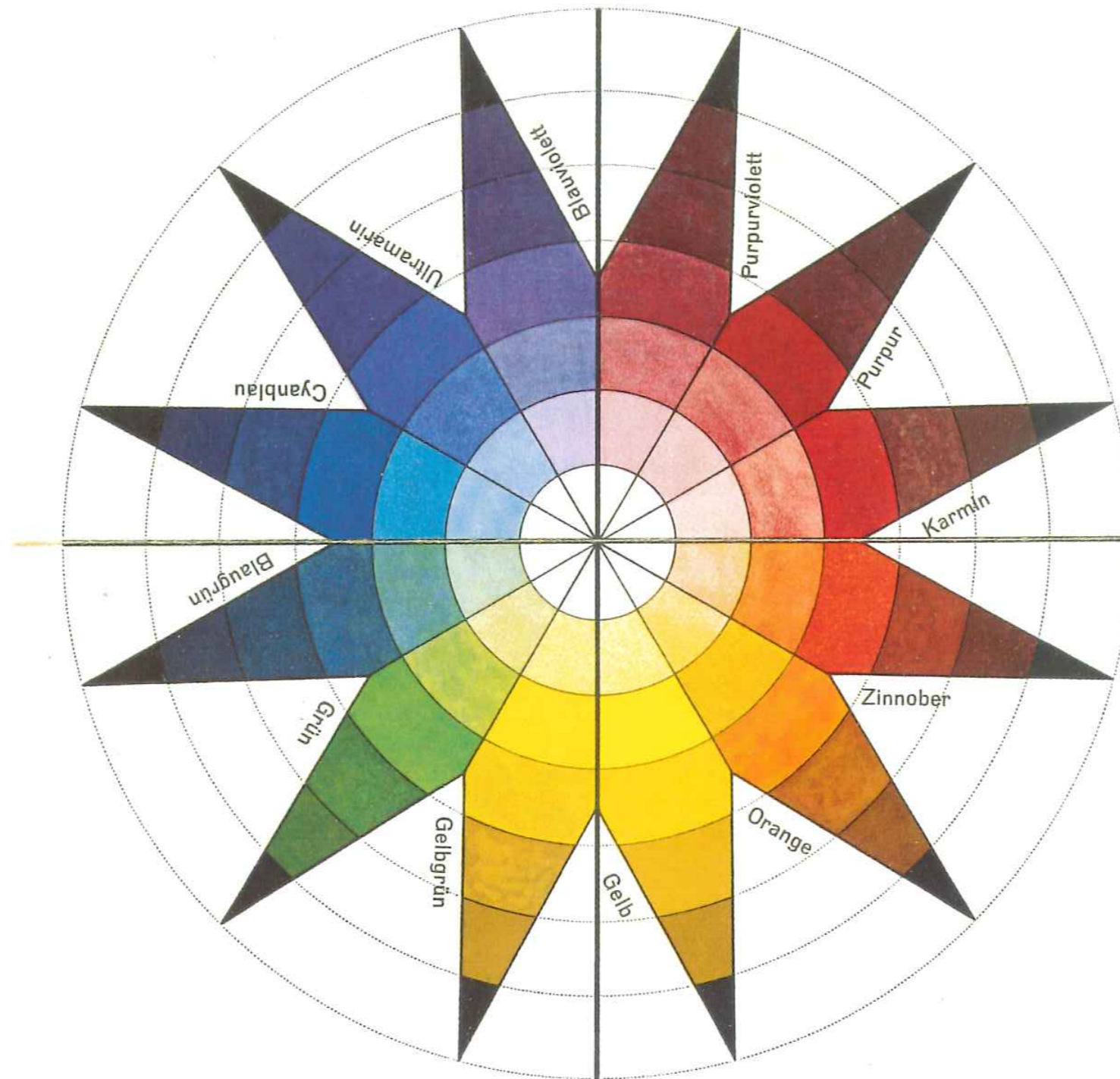

Color Sphere

source: [7]



Marcel Breuer

http://www.boecker-buerogestaltung.de/images/designer/marcel_breuer.01.jpg

source: [8]



Chair B3 “Wassily”

http://upload.wikimedia.org/wikipedia/commons/1/19/Bauhaus_Chair_Breuer.png

source: [8]

Design and Simplicity

- Bauhaus: History and Directors
- Bauhaus: Structure and Products
- From Bauhaus to Braun



http://www.impressionen.de/medias/sys_impressionen/8468670013361232.image.jpg



<http://remodelista.com/img/sub/oilcruet2.jpg>



http://www.bauhaus-shop.de/templates/xt_bauhaus/img/categories/bauhaus_silberteekanne_pr.jpg

Requirements:

Type (variations of the original design)

Basic shape - few simple parts (industrial manufacturing)

Functionality (design for human needs)

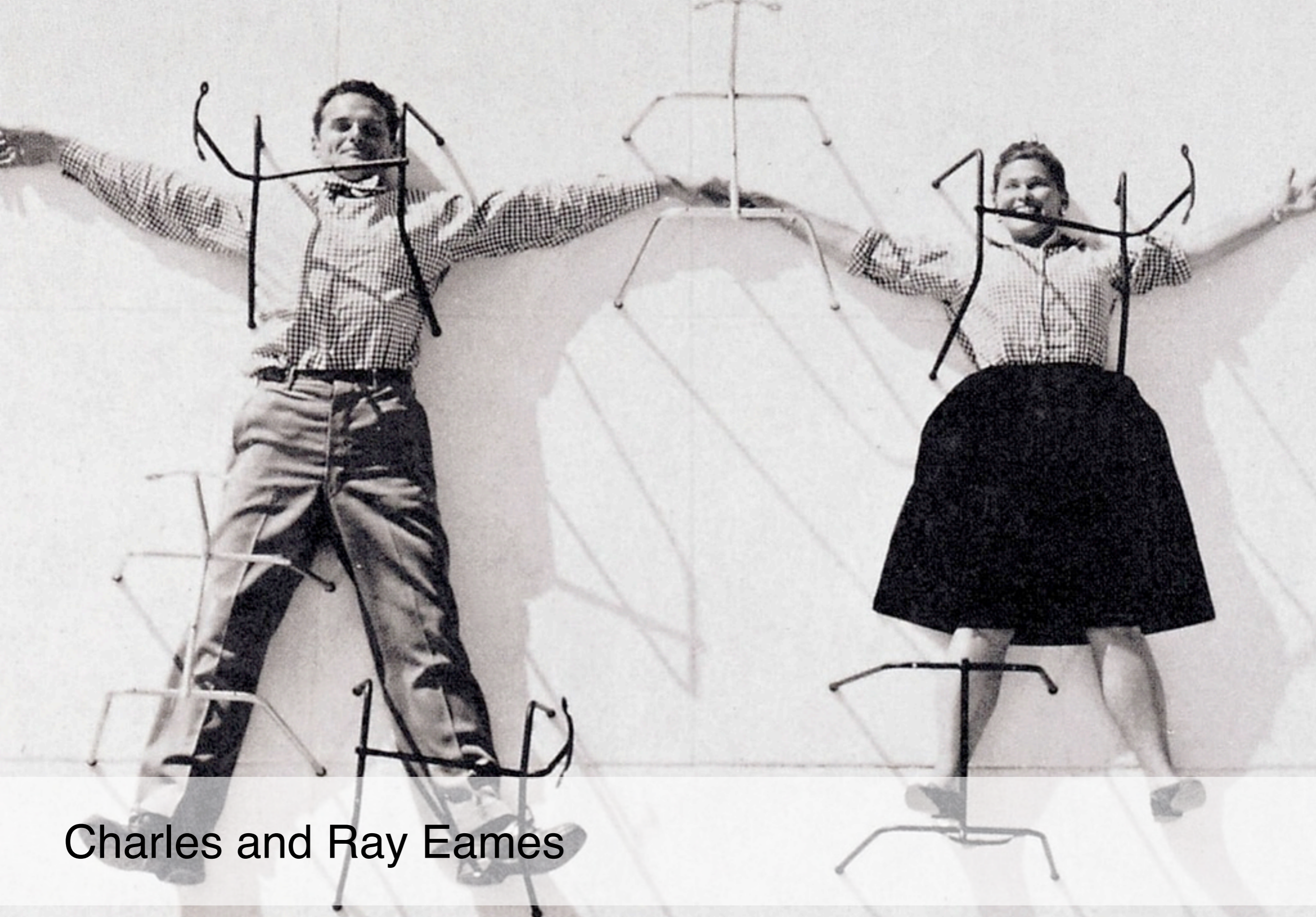

Charles and Ray Eames

<http://luciotraficante.files.wordpress.com/2009/11/charles-ray-eames.jpg>

Ray & Charles Eames







Braun SK6

<http://www.flickr.com/photos/faasdant/3974968657/>



Braun Radio



iPod



iPhone Calculator



Braun Calculator

Part Two

Graphical User Interface Design

- Principles
- Layout, Typography, Color & Contrast
- Controls and Widgets
- Simplicity



Graphical User Interface Design

INTERACTION DESIGN



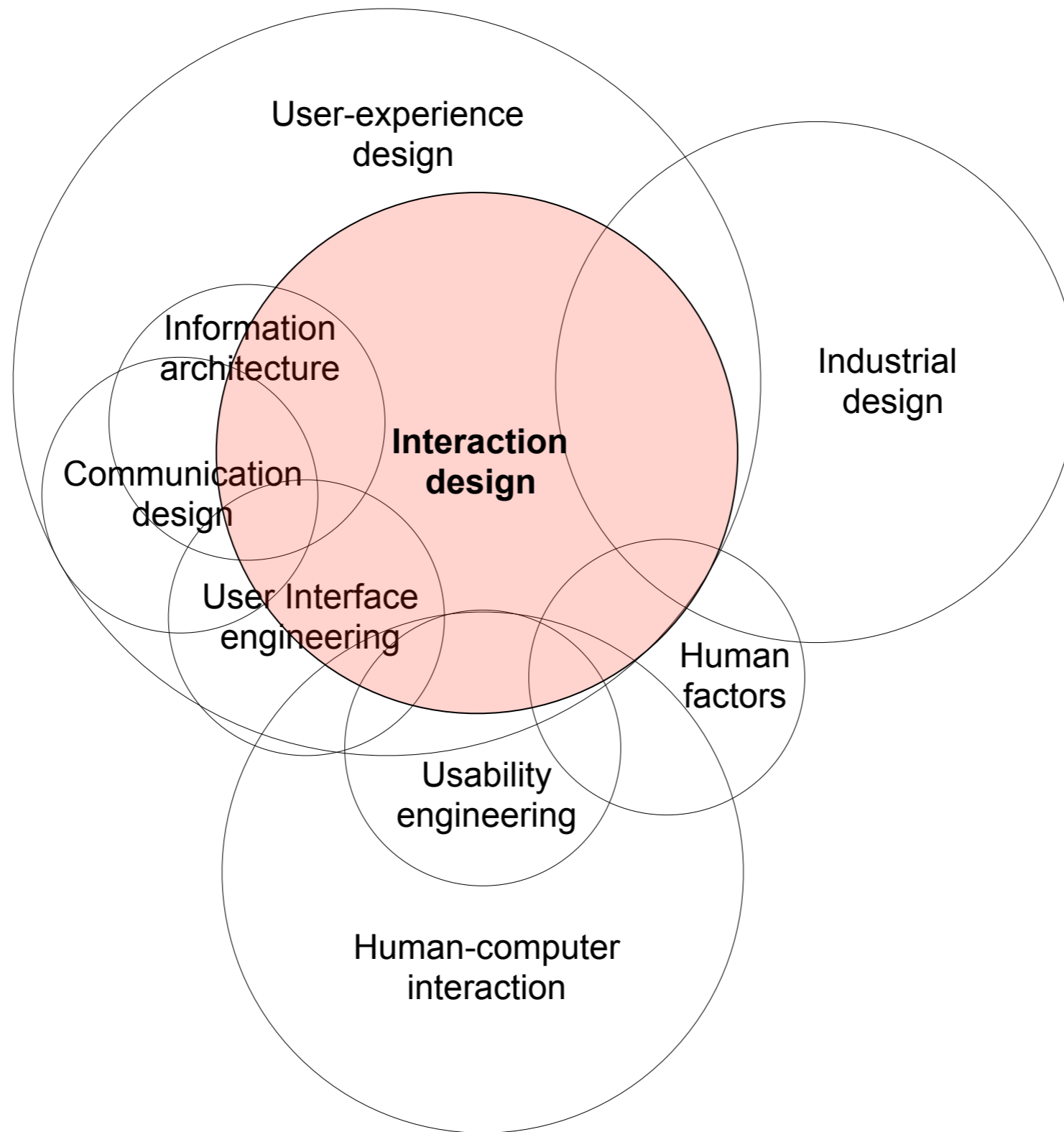

Like all forms of design, visual design is about problem solving, not about personal preference or unsupported opinion.

Bob Baxley

Interface design is only the experienced **representation** of the interaction, not the interaction design itself.



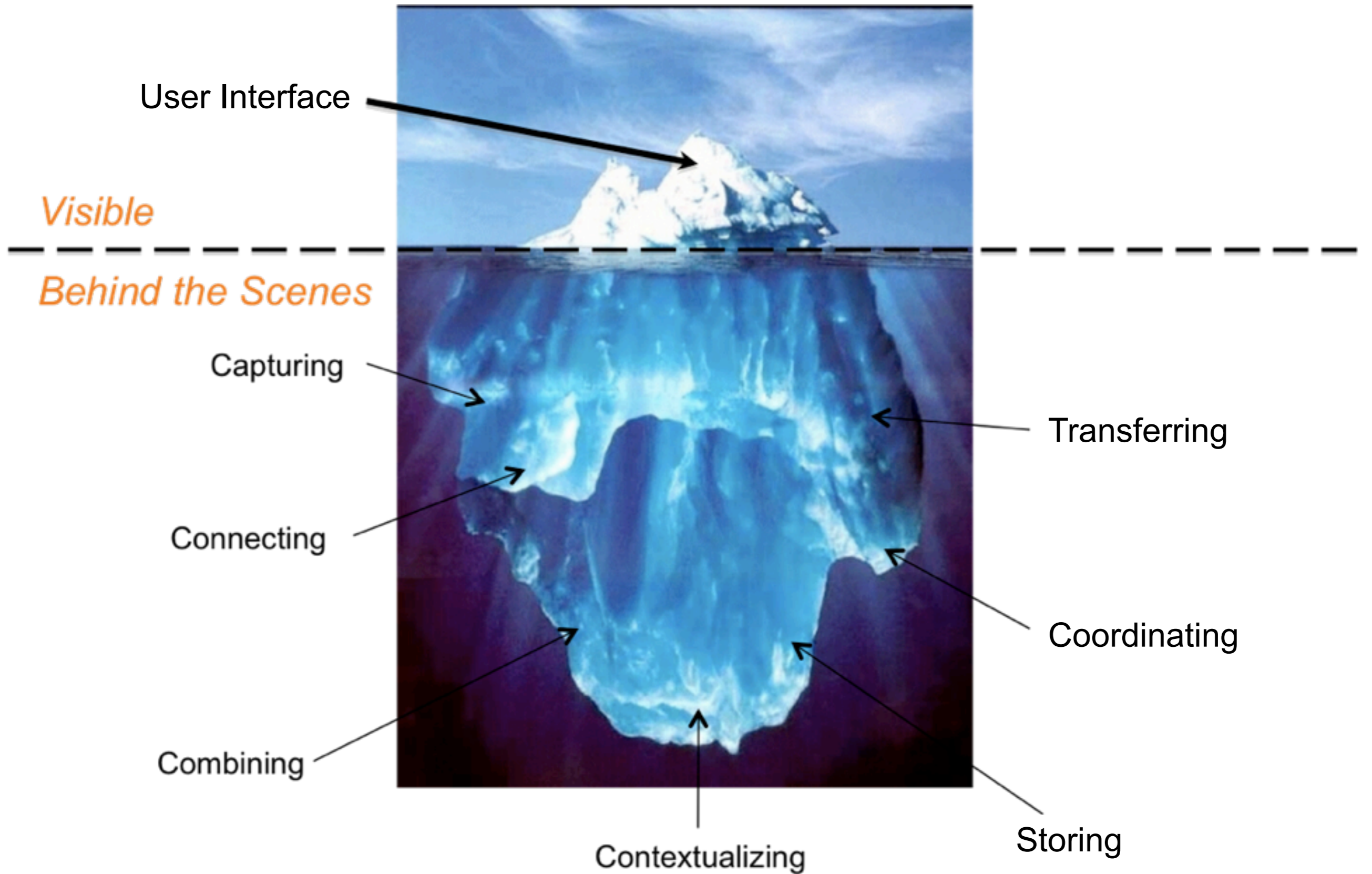

User Interface

Visible

Behind the Scenes

Capturing

Connecting

Combining

Contextualizing

Transferring

Coordinating

Storing

source : [4]



Tools

source : [4]



UI Elements

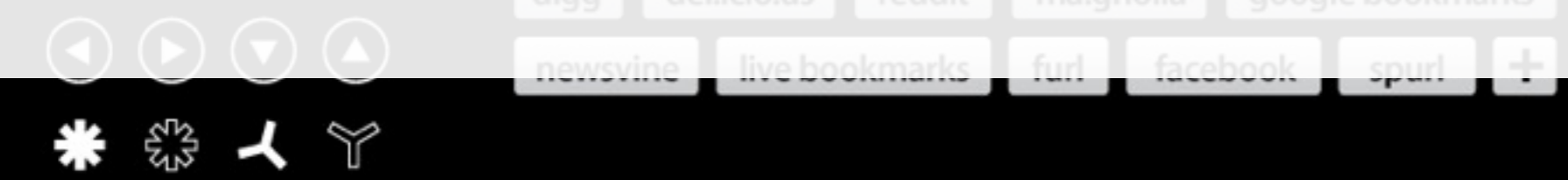

source : [4]

Graphical User Interface Design

- Principles
- Layout, Typography, Color & Contrast
- Controls and Widgets
- Simplicity

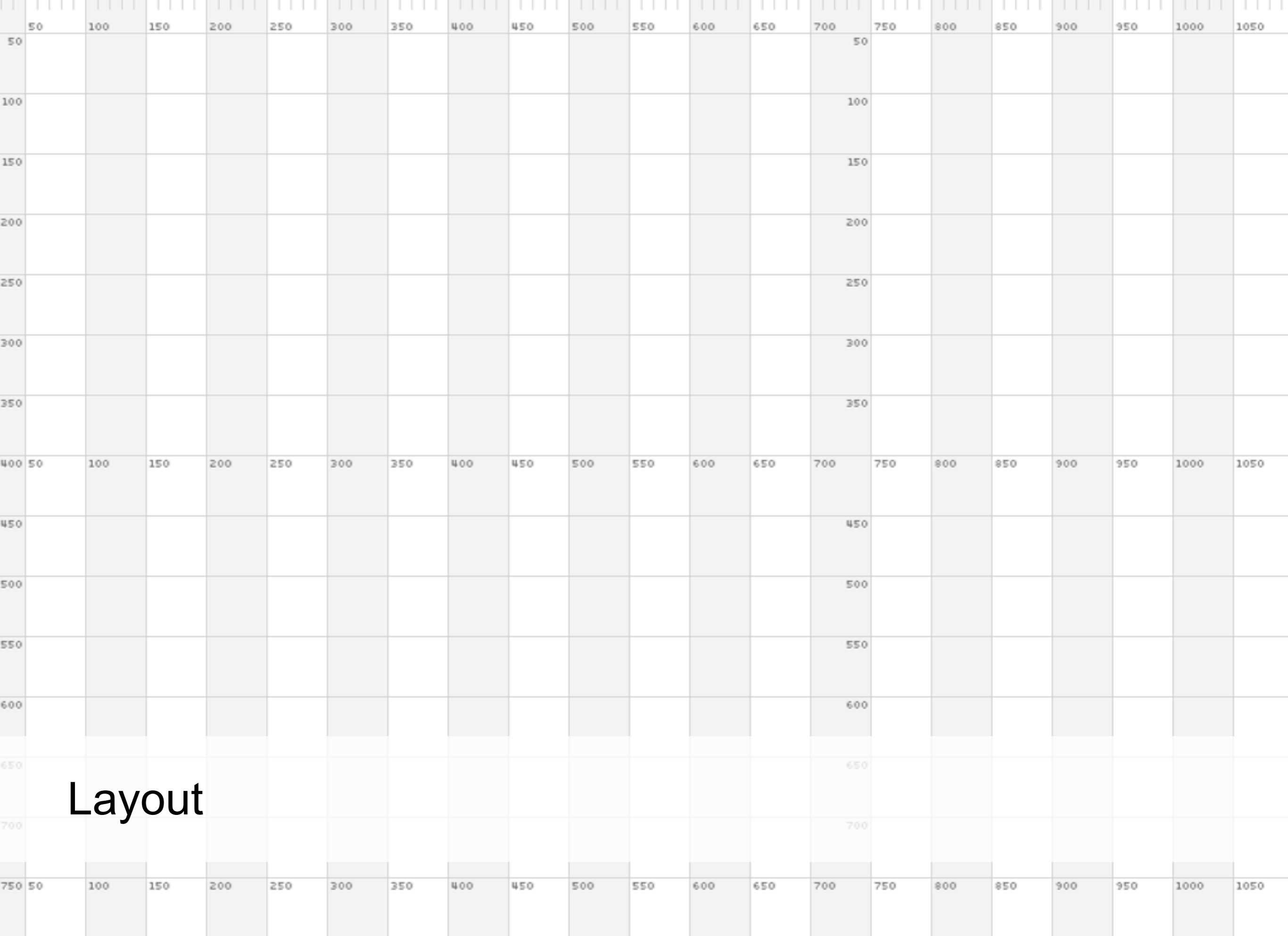

Layout

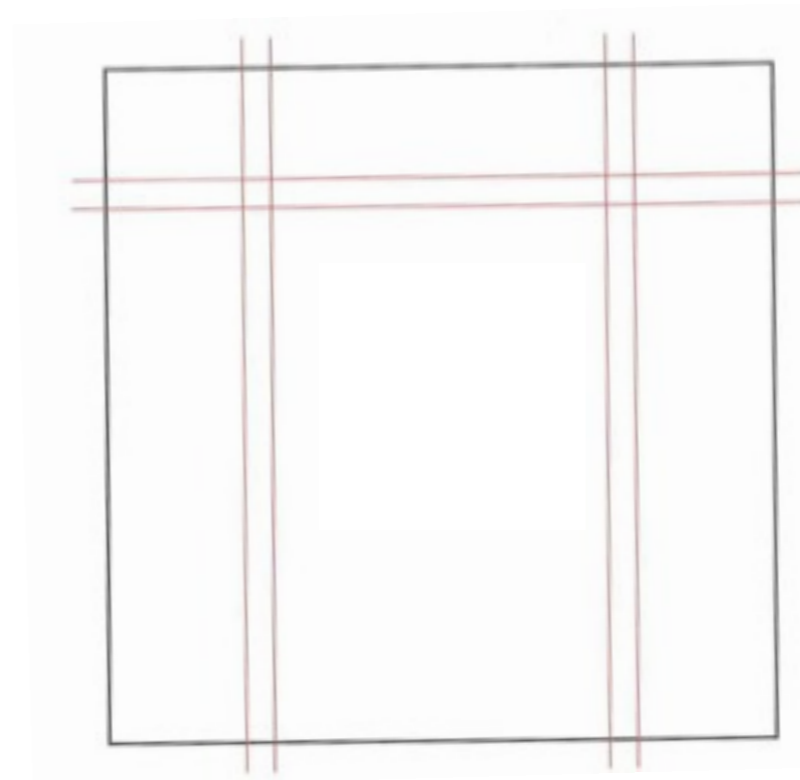
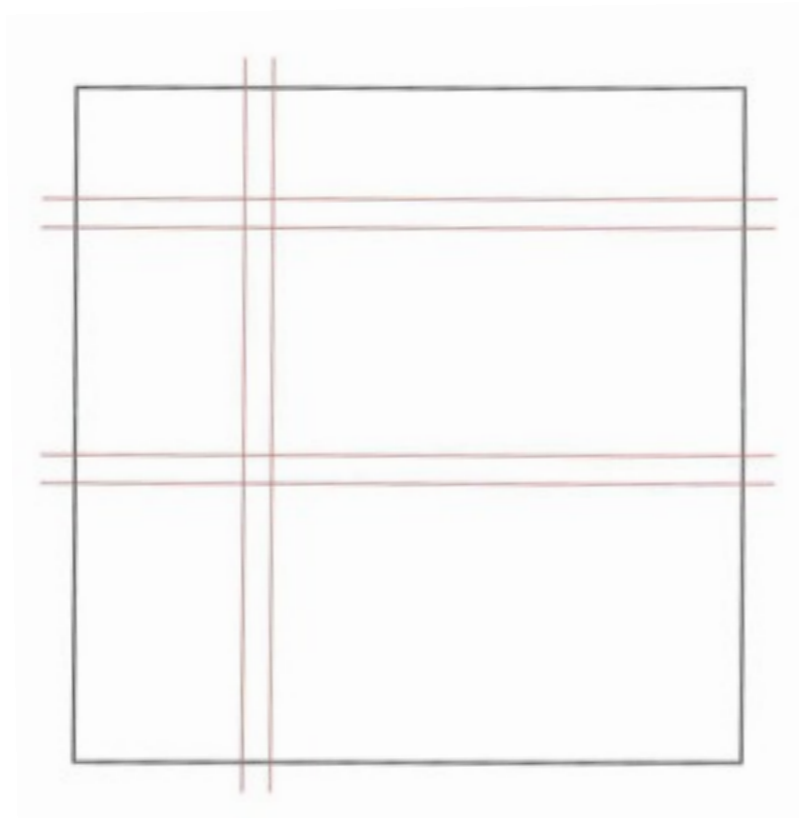
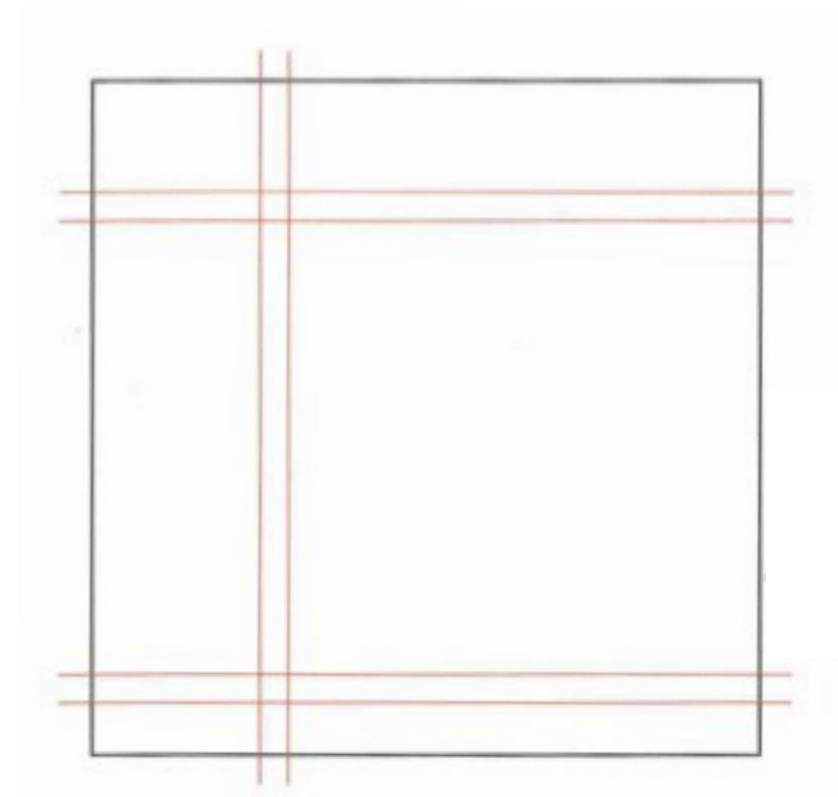
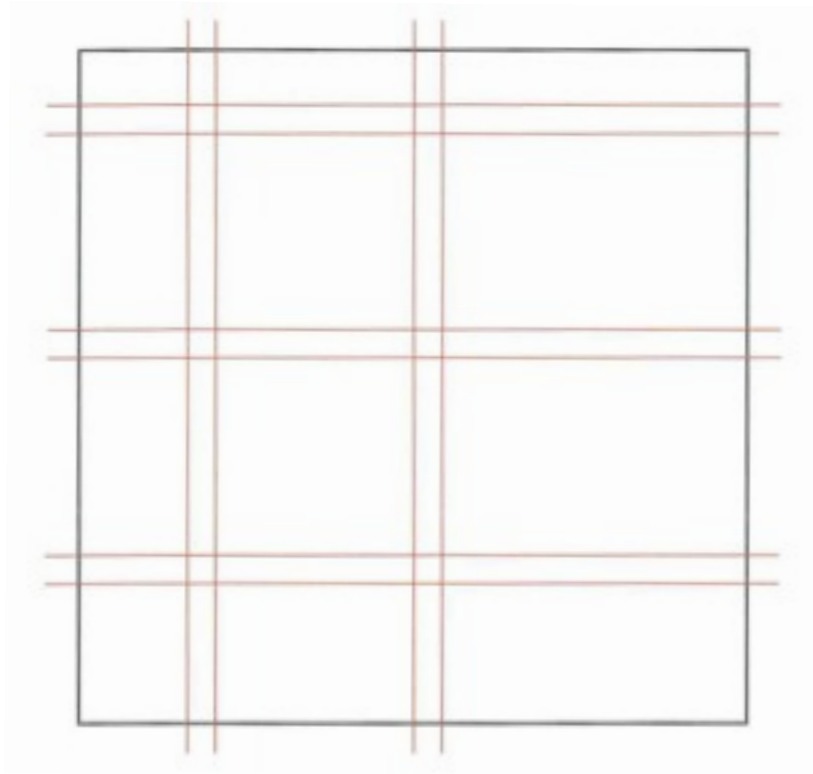

source : [4]

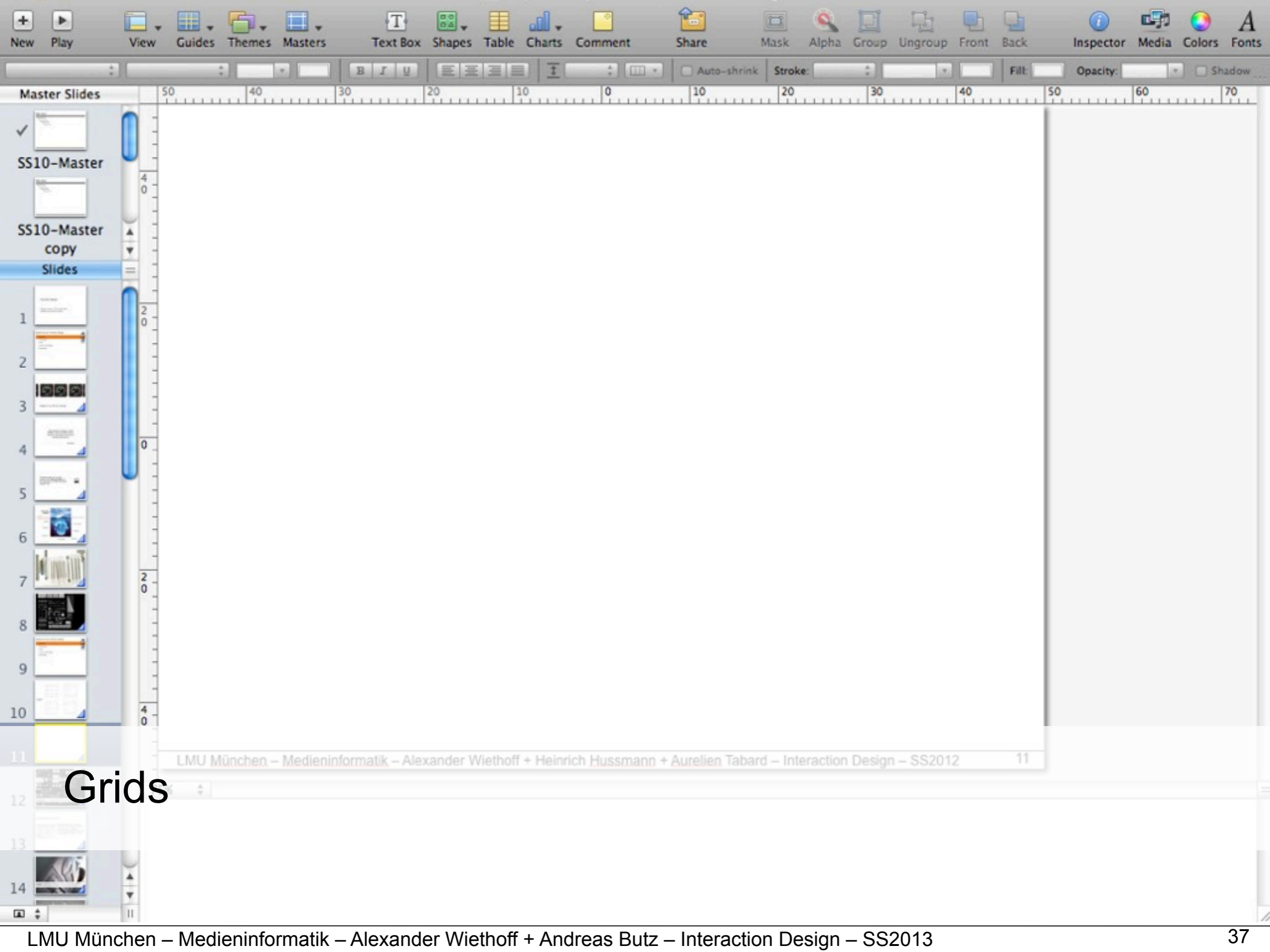

Grids



Welcome to Wikipedia, the free encyclopedia that anyone can edit. 3,994,652 articles in English

- Arts
- Biography
- Geography
- History
- Mathematics
- Science
- Society
- Technology
- All portals

- Main page
- Contents
- Featured content
- Current events
- Random article
- Donate to Wikipedia

- Interaction
 - Help
 - About Wikipedia
 - Community portal
 - Recent changes
 - Contact Wikipedia

- Toolbox
- Print/export

- Languages
 - Simple English
 - العربية
 - Bahasa Indonesia
 - Bahasa Melayu
 - Български
 - Català
 - Česky
 - Dansk
 - Deutsch
 - Eesti
 - Ελληνικά
 - Español
 - Esperanto
 - Euskara
 - فارسی
 - Français
 - Galego
 - 한국어
 - עברית

Today's featured article



The **Cross of Gold speech** was delivered by William Jennings Bryan, a former congressman from Nebraska, at the Democratic National Convention in Chicago on July 9, 1896. In the address, Bryan supported bimetallism or "free silver", which he believed would bring the nation prosperity. He decried the gold standard, concluding the speech, "you shall not crucify mankind upon a cross of gold". Bryan's address helped catapult him to the Democratic Party's presidential nomination; it is considered one of the greatest political speeches in American history. For twenty years, Americans had been bitterly divided over the nation's monetary standard. Many Americans believed bimetallism (making both gold and silver legal tender) was necessary to the nation's economic health. Bryan's speech, delivered at the close of the debate on the party platform, electrified the convention and is generally credited with getting him the nomination for president. However, he lost the general election to William McKinley and the United States formally adopted the gold standard in 1900. [\(more...\)](#)

Recently featured: *Dendrocollybia* – *Killer7* – Calgary Stampede

[Archive](#) – [By email](#) – [More featured articles...](#)

Did you know...

From Wikipedia's newest content:

- ... that during the **Antinomian Controversy**, Anne Hutchinson (*pictured*) withstood two separate trials without counsel before being banished from Massachusetts?
- ... that **Argentine nationalism** sees José de San Martín, Juan Manuel de Rosas and Juan Perón as a line of historical continuity?
- ... that one of the most popular Polish cabarets, **Pod Egidą**, performing since 1967, has faced persecution from the communist authorities in the People's Republic of Poland?
- ... that 2012 College World Series Most Outstanding Player Robert Refsnyder was born in South Korea and adopted by a California couple when he was three months old?
- ... that the print identity of UK music newspaper *The Stool Pigeon* is modelled on Victorian tabloids?
- ... that 2012 Australian Olympic canoeist Hannah Davis won a bronze medal in the sport at the 2008 Summer Olympics?
- ... that the starfish *Anasterias rupicola* feeds on the limpet *Nacella macquariensis*, sometimes hunting it in groups?



In the news

- At least 141 people are killed in a **flash flood** in the Krasnodar Krai region of Russia.
- **The Shard** (*pictured*) in London is inaugurated as the tallest building in Europe, with a height of 310 metres (1,020 ft).
- In association football, the **Copa Libertadores** concludes with Corinthians defeating Boca Juniors in **the Finals**.
- CERN announces the discovery of a new particle with properties consistent with the **Higgs boson** after experiments at the Large Hadron Collider.
- **GlaxoSmithKline** pleads guilty to criminal charges of health care fraud and is fined a record US\$3 billion.
- In association football, **UEFA Euro 2012** concludes with Spain defeating Italy in **the final** to win a second consecutive European Football Championship.



[Wikinews](#) – [Recent deaths](#) – [More current events...](#)

On this day...

July 9: Independence Day in **Argentina** (1816) and **South Sudan** (2011)

- 455 – Roman military commander **Avitus** was proclaimed Emperor of the Western Roman Empire.
- 869 – **An earthquake and subsequent tsunami** struck the area around Sendai, Japan, leaving sand deposits up to 2.5 miles (4 km) inland.
- 1850 – Following Zachary Taylor's death, **Millard Fillmore** (*pictured*) became **President of the United States**, the last member of the Whig Party to hold that office.
- 1962 – In a seminal moment for pop art, **Andy Warhol's Campbell's Soup Cans** exhibition opened at the Ferus Gallery in Los Angeles.
- 2008 – Under the belief that Israel and the United States were planning to attack its nuclear programme, Iran conducted the **Great Prophet III** missile test and war games exercise.



More anniversaries: [July 8](#) – [July 9](#) – [July 10](#)

[Archive](#) – [By email](#) – [List of historical anniversaries](#)

Grids



Visual Clutter

Clutter creates visual noise and
makes an application hard to use

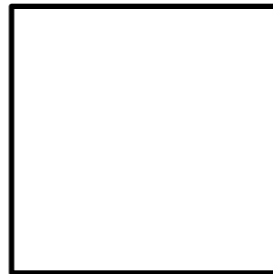

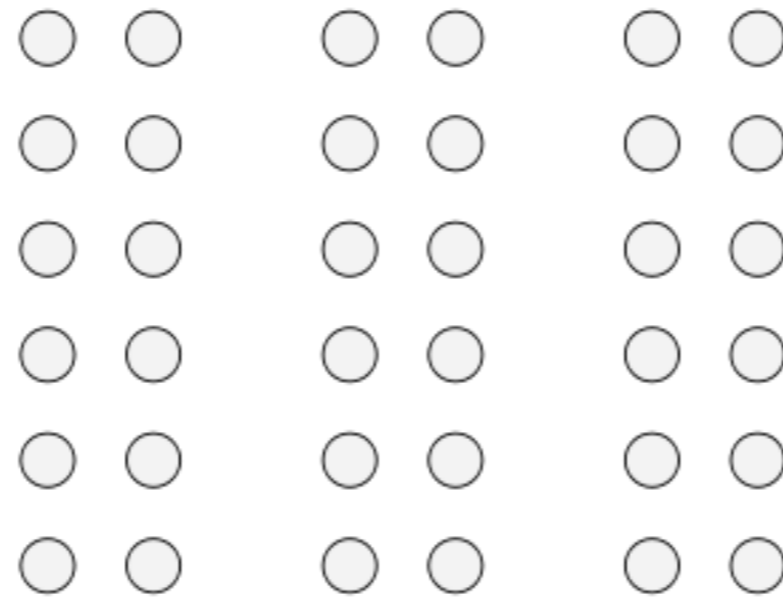
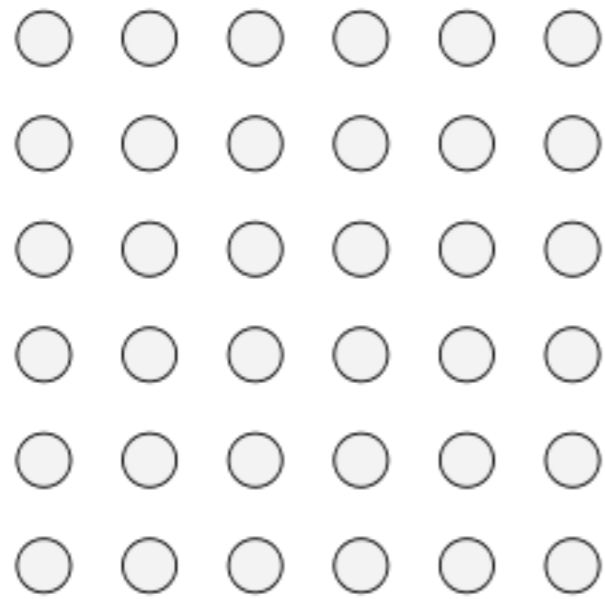

Proximity & Grouping

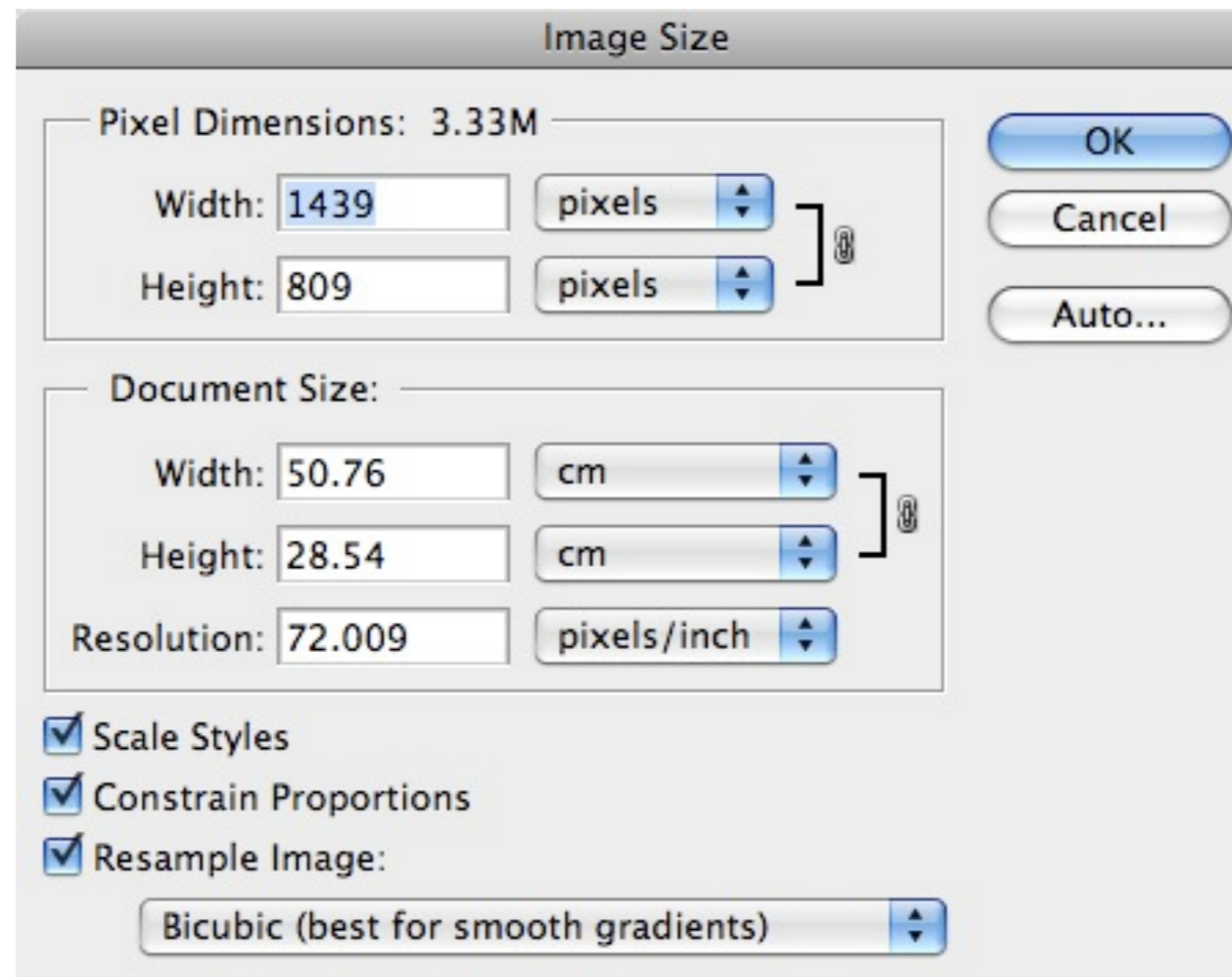

By grouping similar elements together, the designer helps the user deal with a complex information display by reducing it to a manageable number of units.



Primary Action / Secondary Action



All form actions are not equal, and therefore the visual presentation of actions should match their importance to make it easier to complete a form.

Visual distinction helps users make “good” choices.



Example: "Web Design, Filling the Blanks"



Yammer



Constraint

source : [2]

Constraints are closely related to real affordances: For example, it is not possible to move the cursor outside the screen: this is a physical constraint.

Locking the mouse button when clicking is not desired would be a physical constraint. Restricting the cursor to exist only in screen locations where its position is meaningful is a physical constraint.

Flip Horizontally

Flip Vertically

Lock



Unlock

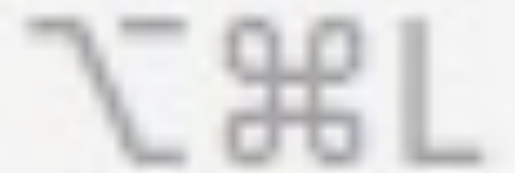

Group

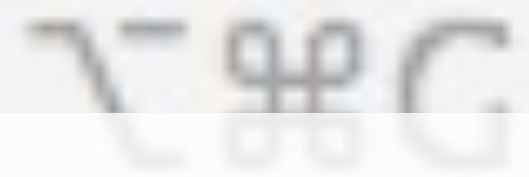

Ungroup

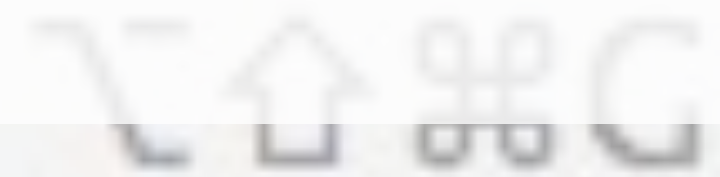

source : [2]

Scalability of Interfaces / Flexibility



80/20 rule

source : [1]

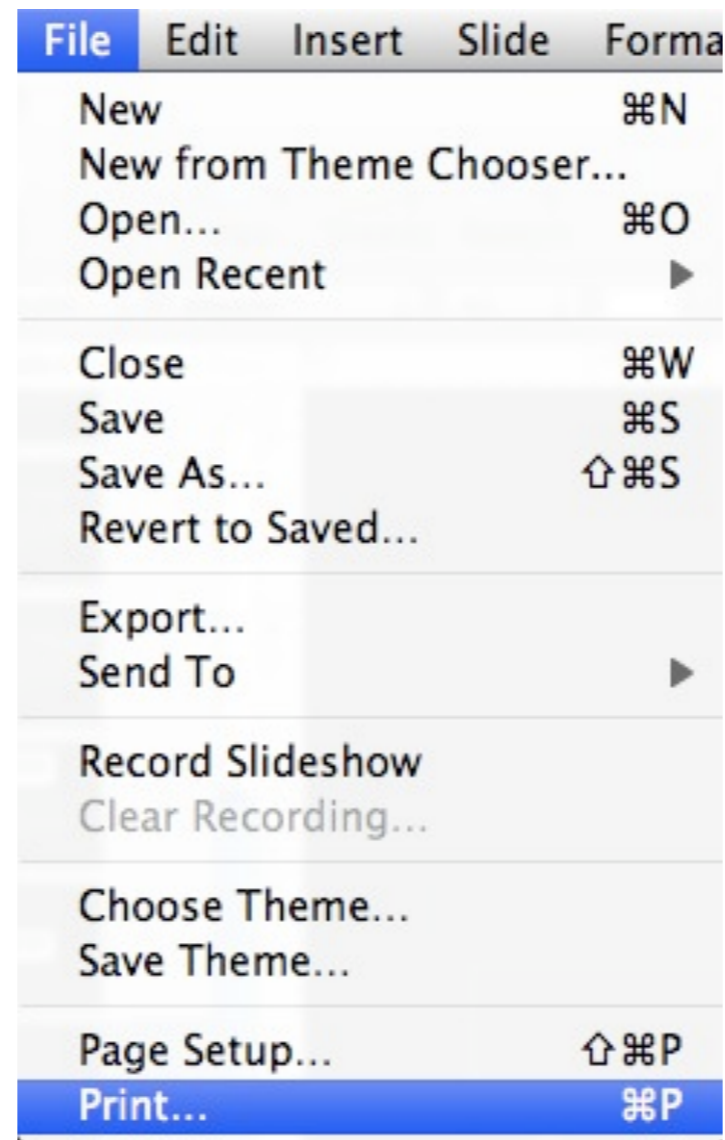

A principle for setting priorities: users will use 20% of the features of your product 80% of the time. Focus the majority of your design and development effort (80%) on the most important 20% of the product.

URL:

Hosts
 Span All
 Allow List ->

Reject List ->

Accept/Reject
 Accept: Reject:
 htm(l) gif
 ipg txt
 zip exe
 doc All

Custom list:

Clear

Special
Retries:
Additional Parameters:

 Act like a browser
 Convert links
 Ignore robots.txt
Configure Proxy

Running Options
 Go 2 background
 No info
 All info
 Some info
 Append to logfile
 Overwrite Logfile
Logfile:

Retrieval Options
 No clobber
 Timestamping
 Continue file download
Quota (kB):
 Spider (check for files)
 No directories
 Force directories
 Save to custom dir:

 Clear Server Cache
 Recursive Retrieval
Depth:
 Download "as-is"
 Mirror site
 add HTML suffix
 Only go deeper

Overcrowded Widget

Load settings About Exit
Start wGetStart.bat Add to wGetStart.bat Empty wGetStart.bat Pro Mode

Users are overwhelmed by options, limitless flexibility

Only show me what I need to see

Implement one easy to discover and easy to learn core pattern for common actions across the platform.

Adjust to users' preferences.

Make less common actions harder to reach.



Aesthetic-Usability Effect

source : [1]



Aesthetic-Usability Effect

Aesthetic designs are perceived as easier to use than less-aesthetic designs.

Aesthetic designs look easier to use and have a higher probability of being used, whether or not they actually are easier to use.

source : [1]

The flexibility-usability tradeoff is exemplified in the well known maxim “jack of all trades, master of none”.

Flexible designs can perform more functions than specialized designs, but they perform the functions less efficiently.





Fonts

Courier
CourierBold
CourierBoldOblique
Helvetica
HelveticaBold
HelveticaBoldOblique
HelveticaOblique
TimesBold
TimesBoldItalic
TimesItalic
TimesRoman

- two general groups: serif & sans serif
- sans serif can be scanned quickly
- avoid very heavy or light typefaces for UIs
- avoid combining too similar typefaces
- stick with standards first

A B C D E F

A B C D E F

Roboto

THIN

SUNGLASSES

BLACK SMALL CAPS

ITALIC

Self-driving robot ice cream truck

BOLD

Fudgesicles only 25¢

BOLD CONDENSED

ICE CREAM

MEDIUM

Marshmallows & almonds

LIGHT

#9876543210

BOLD ITALIC

Music around the block

REGULAR

Summer heat rising up from the sidewalk

source : [5]

Colors

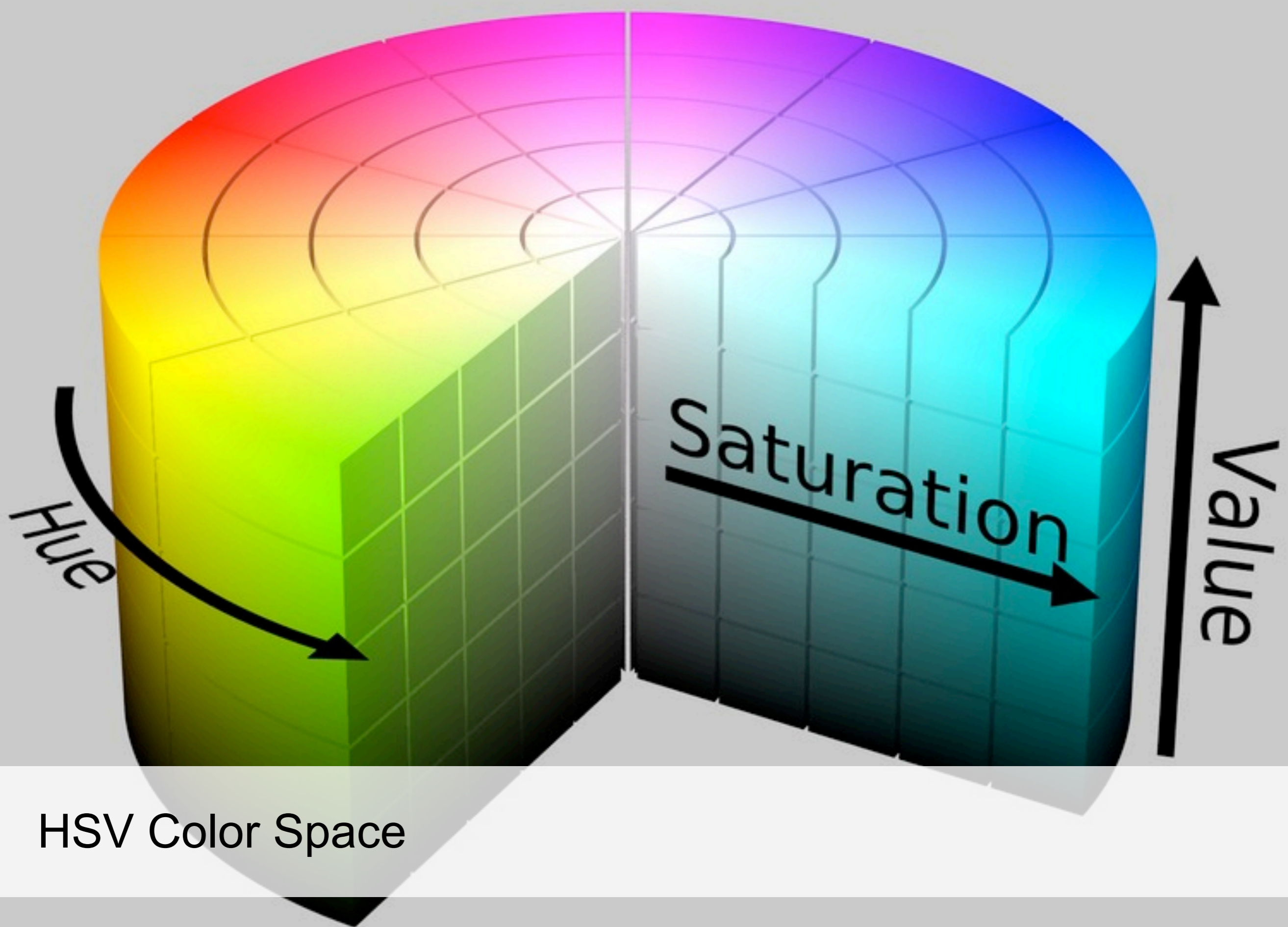

- three main properties: hue, saturation (or intensity) and value (or brightness)
- hue refers to the color itself (the particular color within the optical (visible) spectrum of light), saturation refers to the brightness, value refers to the amount of black in a color

- color can provide cues for use
- color can establish a relationship
- color can indicate importance
- consider human factors such as color blindness and cultural differences

Colors

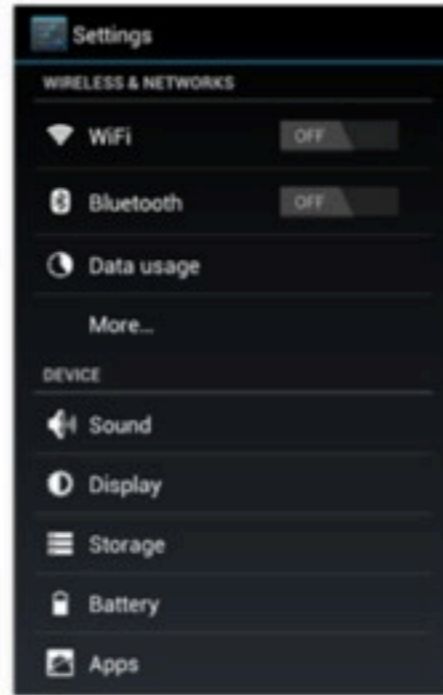
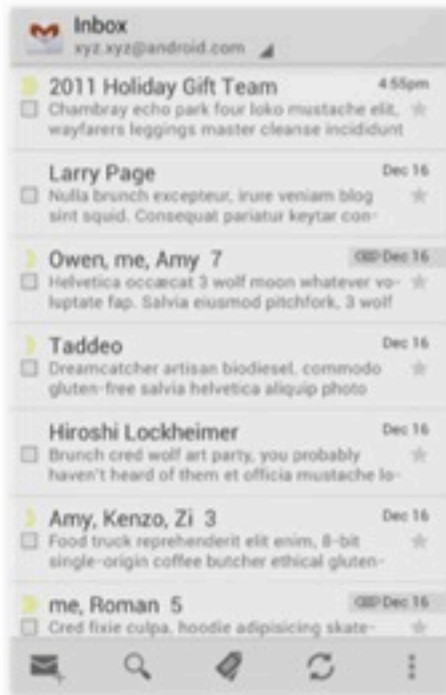

Ads Rates Site Stats WeBLOG-12/31/06
LINKS View/Add FREE Classifieds/View/Add

Welcome to the hosanna1.com Portal Page
Home of AAA World Wide Web Design
& Hosanna Afghan Hounds

Welcome to
www.hosanna1.com
PORTAL Page HOME OF
The Most Beautiful Pages On The WWW
Hosanna Afghan Hounds
& AAA World Wide Web Design

3A Home Business Resources and Education
Background ~ MY RESUME ~ ASP
NEW! The Most Beautiful MUSIC On The WWW!
hosanna1.com JUKEBOX!!!

AN AMERICAN who LOVES
FREEDOM? CLICK HERE

We BOYCOTT ALL Smoking Ban Areas- CLICK HERE
EMERGENCY - HELP SAVE OUR PETS!
CA Smoking Ban Costs them 100 Billion\$
Smoker's Health & Rights hosanna1.com Weblog

JOHN & LYNDA FARLEY EDMONTON, KENTUCKY
CLICK HERE TO EMAIL US



Hoopla Sculpture
EMAIL ARTIST AT: kvalimaki@aol.com

Questionable Website

USE REFRESH BUTTON - We Update OFTEN FULL SCREEN SETTING
ARCHIVES | AFGHAN HOUNDS: | Gwich'in | Hosanna+PUPPIES!
| Mahadi | Polo ~ BIS National Specialty 2003
travel-hound | Other DOG Breeds: Cyrano Hounds (whippets/greyhounds)
| Play Kennel (KEES/PYRS) KEESHOND PUPPIES HERE NOW!
SKY Shelties | ART/CobraOriginals Afghan, dog breeds, horses
HORSES: Step Of Faith Farm | SPIRITUAL: 911 | AALF



SOME SAY TIMES ARE CHANGING,
Hosanna Afghans HISTORY Page CLICK HERE

From the Mouths of Babes
~~~~~  
My daughter said, 'I wonder...'  
~~~~~  
I had NEVER thought of
that, so I did a Bible Search...

NEVER FORGET!



LOST
AFGHAN HOUNDS
Joy - in Indiana
CLICK HERE

PRECIOUS is still lost

We have BEAUTIFUL PUPPIES available SOON, whelped JUNE 17, 2010, with AKC Champion sire & dam!

We also have some BEAUTIFUL Champion sired young male and female Afghan Hounds AVAILABLE NOW. If you have room in your heart to love one of these 'most beautiful dogs in the world, please check out THIS PAGE

COME SEE THE MOST BEAUTIFUL ART CAR IN THE WORLD, AWARD WINNING PARADE CAR, AND OUR HOSANNA AFGHAN HOUNDS DOG SHOW





Contrast

source : [2]

Effective design creates no more contrast than necessary.

This allows the viewer to easily identify the elements in question as a strongly defined subset of the available information.



Show All

Language For

Region: Custom

Dates

Saturday, 5 January 2008

5 January 2008

5 Jan 2008

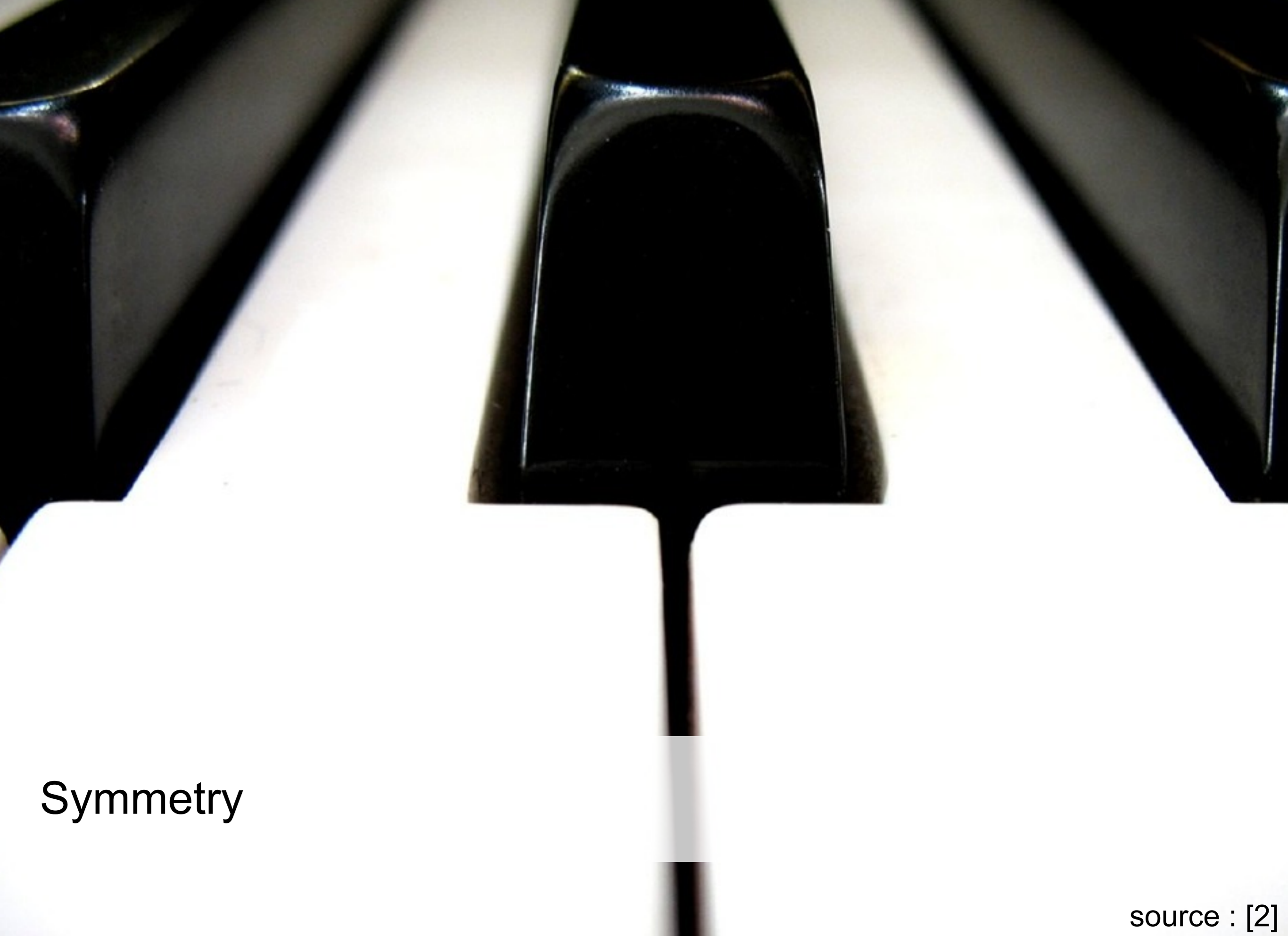

Symmetry

source : [2]



Symmetry ensures balance and clear organization, if sometimes at the expense of visual interest. While this may be a drawback for a poster or retail packaging, it is perfectly appropriate for a user interface.

UI Kits



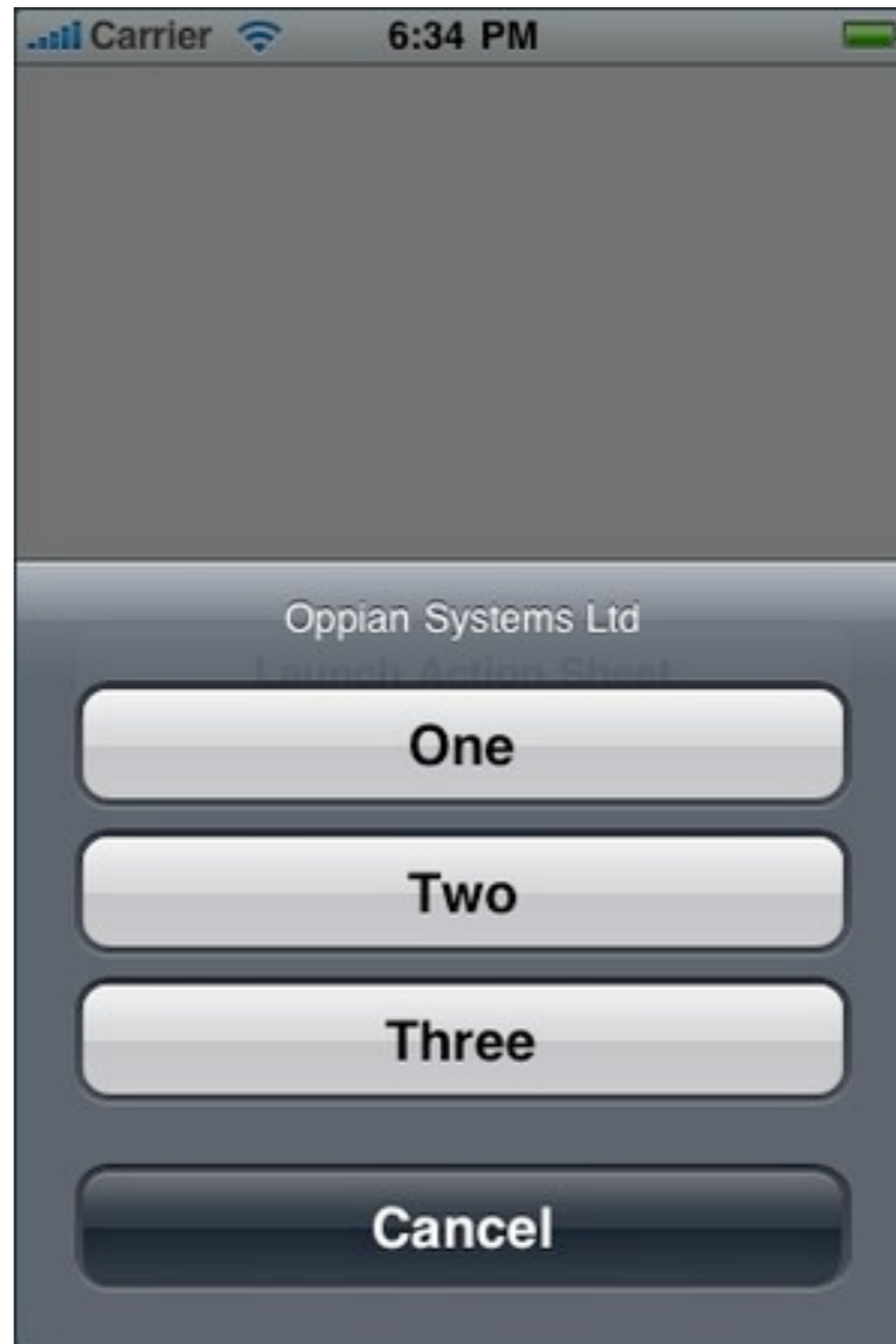

Browse Create Search Community Channels Trends Tools Store

Explore Over a Million Color Palettes

You'll find over 1,666,068 user-created color palettes to inspire your ideas. Get the [latest palettes RSS feed](#) or use our [color palette maker](#) to create and share your favorite color combinations.

NEW MOST LOVED MOST VIEWS MOST COMMENTS MOST FAVORITES



Browse Palettes DAY WEEK MONTH ALL

Giant Goldfish by manekineko

508 COMMENTS 3005 FAVORITES 232796 VIEWS 3510 LOVES

Thought Provoking by Miss_Anthropy

285 COMMENTS 1938 FAVORITES 139170 VIEWS 2738 LOVES

Terra? by GlueStudio

442 COMMENTS 1567 FAVORITES 89562 VIEWS 1463 LOVES

RECENT PALETTE COMMENTS

huege POSTED 2 MINUTES AGO

Lovely pattern Dawn! After a few minutes of looking at it, I realized she had a cigarette :) American Women wrote:

Smoking Lady by American Womer

3 FAVORITES 0 COMMENTS Rank #137256 COLOURlovers.com

huege wrote:

I love it! I don't know why, but to me this looks like the palette should on a package of cigarettes. I don't even smoke, but I love the palette so much that I think it's making me want to start smoking?!?!

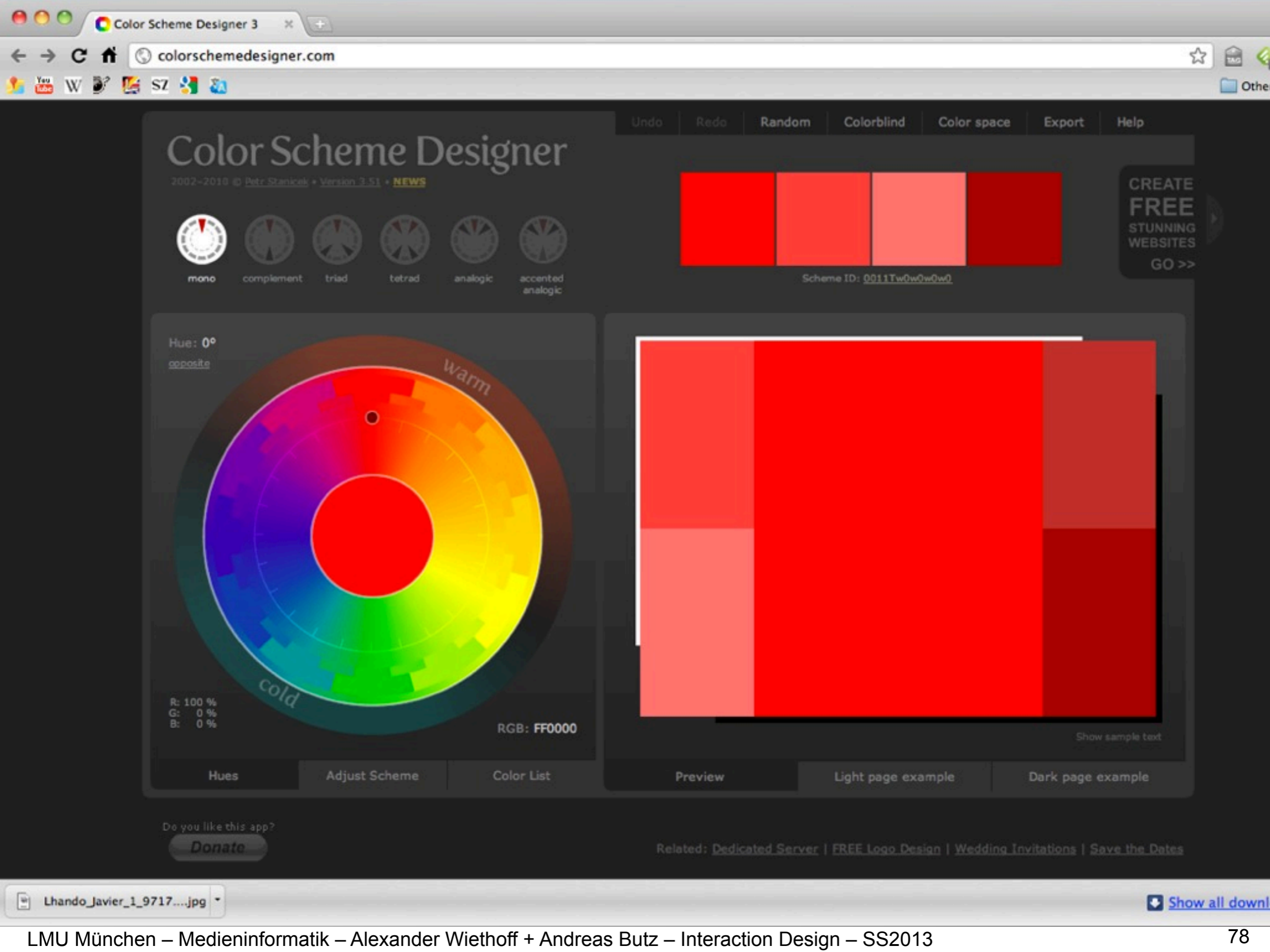

Color Scheme Designer

2002-2010 © Petr Staníček • Version 3.51 • [NEWS](#)

- mono
- complement
- triad
- tetrad
- analogic
- accented analogic

Hue: 0°
[opposite](#)



R: 100 %
G: 0 %
B: 0 %

RGB: FF0000

- Hues
- Adjust Scheme
- Color List

- Undo
- Redo
- Random
- Colorblind
- Color space
- Export
- Help



Scheme ID: [0011Tw0w0w0w0](#)

CREATE
FREE
STUNNING
WEBSITES
GO >>

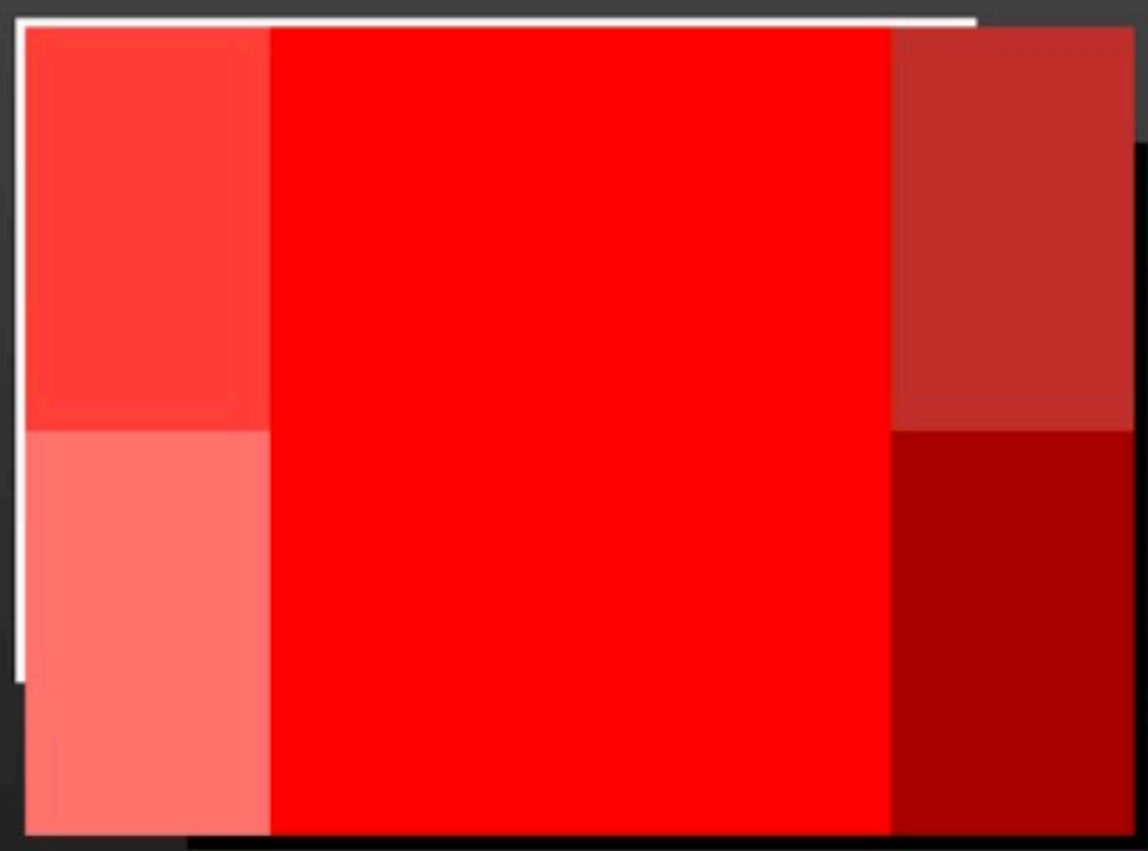

- Preview
- Light page example
- Dark page example

Do you like this app?
[Donate](#)

Related: [Dedicated Server](#) | [FREE Logo Design](#) | [Wedding Invitations](#) | [Save the Dates](#)

Lhando_Javier_1_9717....jpg

Show all download

Graphical User Interface Design

- Principles
- Layout, Typography, Color & Contrast
- Controls and Widgets
- Simplicity



Switch

<http://fbelec.en.made-in-china.com/product/QeZnlxqkZikC/China-Switch.html>



Button

[http://www.conrad.de/ce/de/product/701855/Vandalismusgeschuetzter-Taster-16-mm-mit-Ringbeleuchtung-48-VDC-2-A-GQ16F-10EJB12V-Loetpins-48-VDC-2-A/SHOP_AREA_17386&promotionareaSearchDetail=005](http://www.conrad.de/ce/de/product/701855/Vandalismusgeschuetzter-Taster-16-mm-mit-Ringbeleuchtung-48-VDC-2-A-GQ16F-10EJB12V-Loetpins-48-VDC-2-A/)



Dial

<http://www.conrad.de/ce/de/product/718295/Universal-Geraetknopf-mit-Skala-A-x-B-x-C-mm-23-x-37-x-233-Aluminium-eloxiert-Aluminium-eloxiert-Achs-Durchmesser/?ref=search>

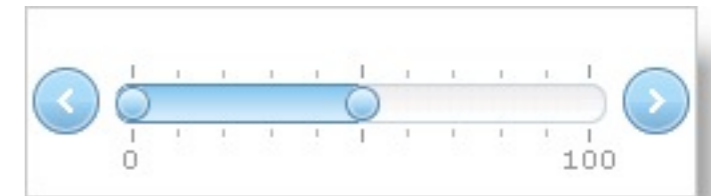

Slider

http://help.infragistics.com/Help/NetAdvantage/ASPNET/2011.2/CLR4.0/html/images/Web_New_WebSlider_Control.png

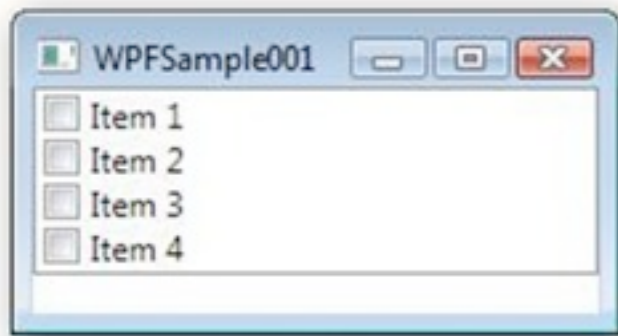

Checkbox

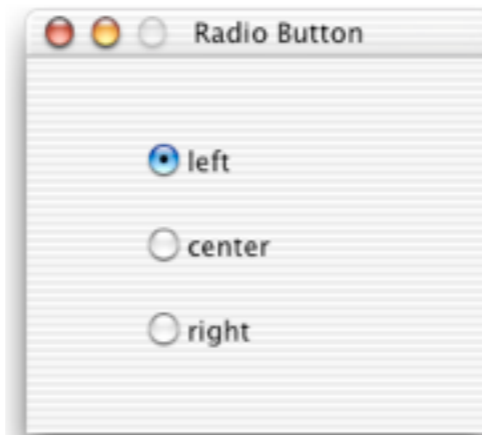

Radio Button

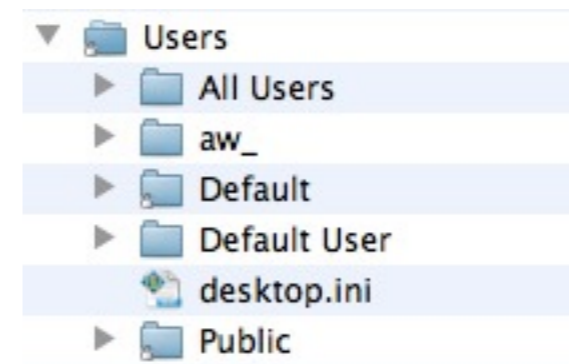

Twist

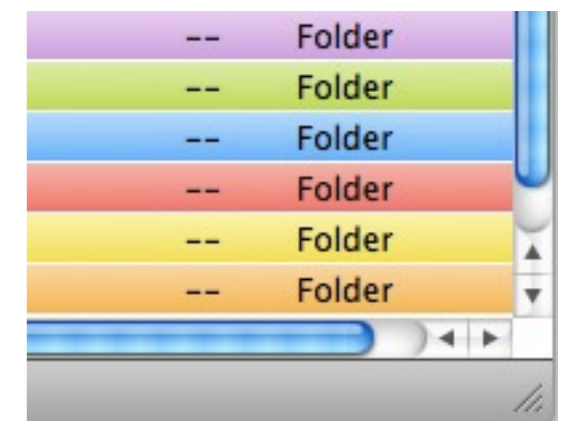

Scroll Bar

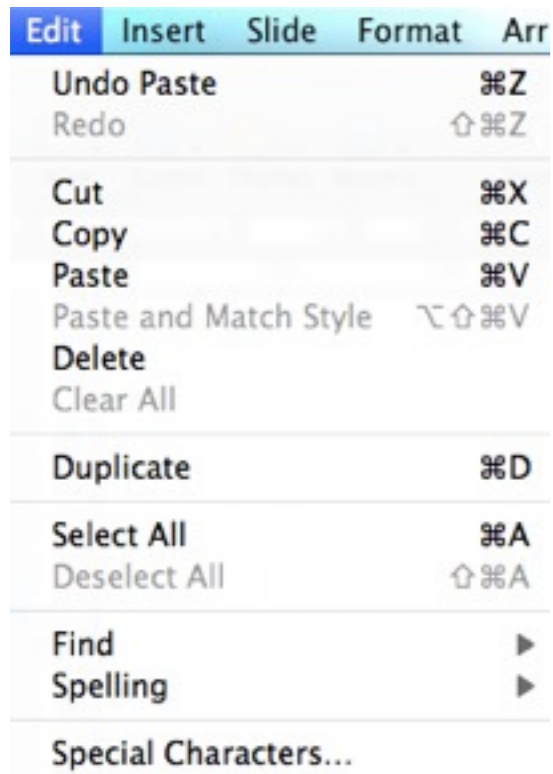

Drop-down menu



Multiple Selection List

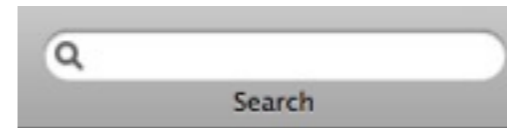

Text Box

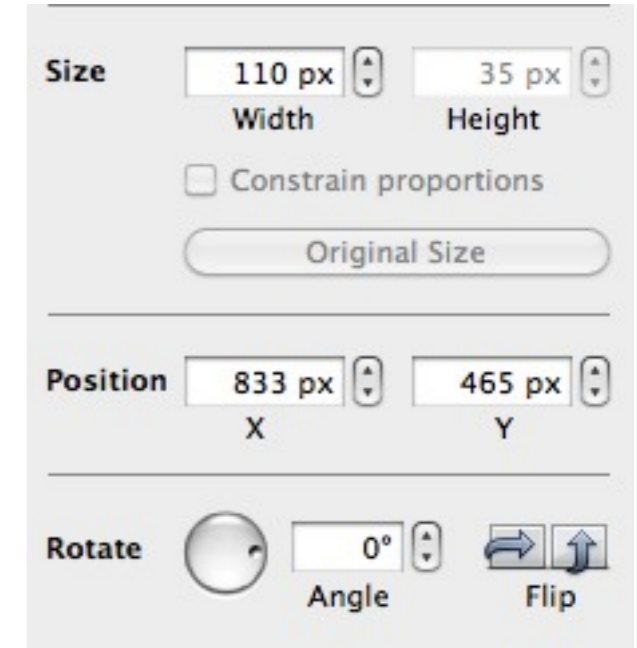

Spin Box



Controls



Controls

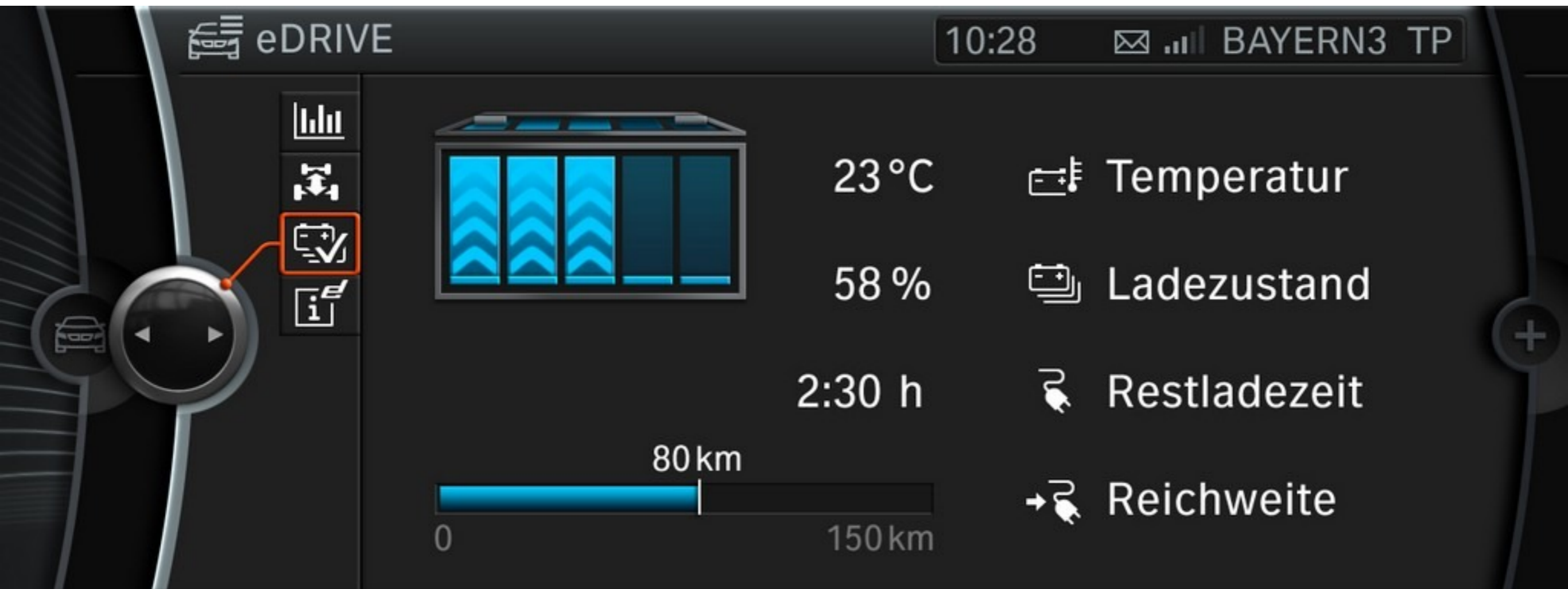

Mapping of Representation and Control

Graphical User Interface Design

- Principles
- Layout, Typography, Color & Contrast
- Controls and Widgets
- Simplicity



Simplicity



Approachability

Simple designs can be rapidly apprehended and understood well enough to support immediate use or invite further exploration.



Recognizability

Simple designs can be recognized more easily than their more elaborate counterparts. Because they present less visual information to the viewer, they are more easily assimilated, understood and remembered.



Immediacy

Simple designs have a greater impact than complex designs, precisely because they can be immediately recognized and understood with a minimum of conscious effort.



Usability

Improving the approachability and memorability of a product necessarily enhances usability as well. Simple designs that eliminate unnecessary variation or detail make the variation that remains more prominent and informative.

source : [2]

Reduction through successive refinement is the only path to simplicity

References (Books):

- [1] Lidwell, W., Holden, K. and Butler, J. Universal Principles of Design, Revised and Updated: 125 Ways to Enhance Usability, Influence Perception, Increase Appeal, Make Better Design Decision, Second ed. *Rockport, 2010.*
- [2] Mullet K. and D. Sano, Designing Visual Interfaces: Communication Oriented Techniques, 1st ed. *Prentice Hall, 1994.*
- [3] Moggridge, B. Designing Interactions, *MIT Press, 2006.*
- [4] Saffer, D. Designing for Interaction, *New Riders 2009.*
- [5] Ouilhet, H. The soul of the new machine: A story about Android design, *UX LMU Talks 2011-12.*
- [6] Buxton, W. Sketching the User Experience, Elsevier 2007
- [7] Droste, M. Bauhaus, *Taschen 2010.*
- [8] Fiedler, J. & Feierabend, P. Bauhaus, *Könemann in der Tandem Verlags-GmbH 2005.*