

Smart graphics: Overview of lecture content, rules & conditions

Lecture „Smart Graphics”
Andreas Butz, Sebastian Boring

19.10.2005

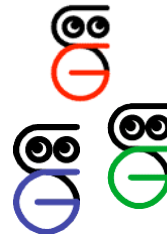

Topics Today

- The term “Smart Graphics”
- Topics of the lecture
- Exercises
- Conditions for getting the certificate
- Useful resources

International Symposium on
Smart Graphics

2005

2000 2001 2002 2003 2004

LMU München – Medieninformatik – Butz/Boring – Smart Graphics – SS2007 – Intro – Folie 3



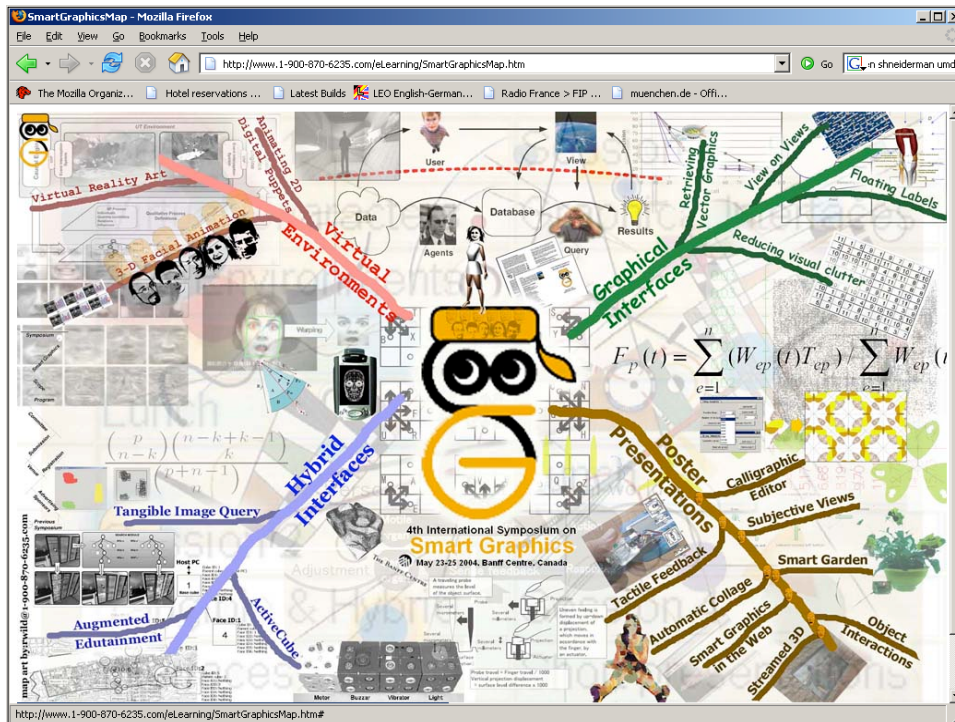

Goal: 4 disciplines talking to each other

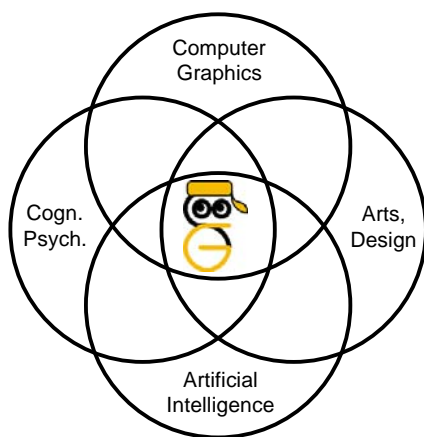

- Designers have produced graphics forever
- Psychologists tell us how humans perceive and process
- AI provides the tools to use this knowledge
- Computer Graphics provides the medium

Examples of Smart Graphics

Mapmaker

(Agrawalla & Stolte, SG 2000)

- Ziel ist die automatische Generierung von Wegskizzen
- Berücksichtigung von Designregeln
- Gute Verständlichkeit und Handhabbarkeit

Motivation

- Statisches Kartenmaterial



(a)

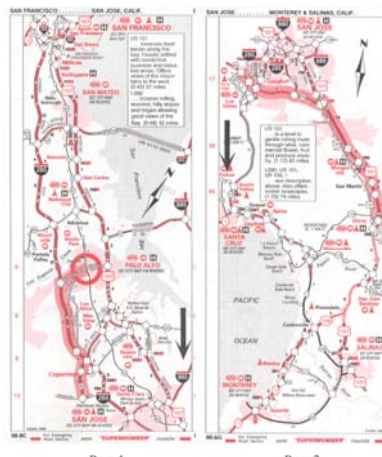

Page 1

Page 2

(b)

Motivation

- Schlechtes dynamisches Kartenmaterial



(a)



(b)

MapBlast



Skizzengenerierung

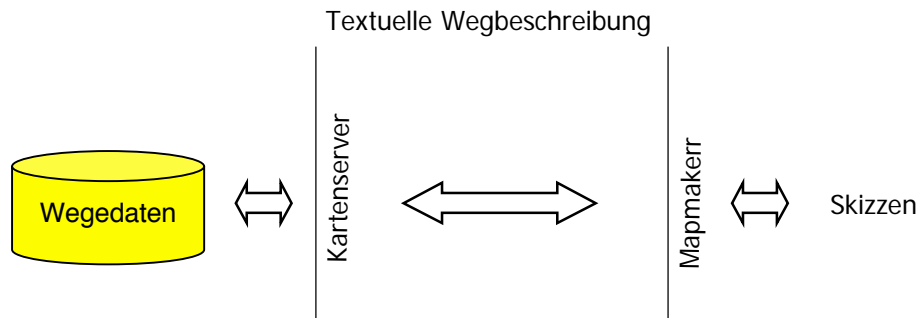

LMU München – Medieninformatik – Butz/Boring – Smart Graphics – SS2007 – Intro – Folie 13

Generierungsschritte

- Platzierung der Wegstrecken
- Platzierung von Bezeichnern
- Hinzufügen von Hilfselementen
- Realisieren des „handgezeichneten“ Stils der Wegskizze

- Kriterium:
 - Längenverhältnisse müssen erhalten bleiben

LMU München – Medieninformatik – Butz/Boring – Smart Graphics – SS2007 – Intro – Folie 14

Generierungsergebnis

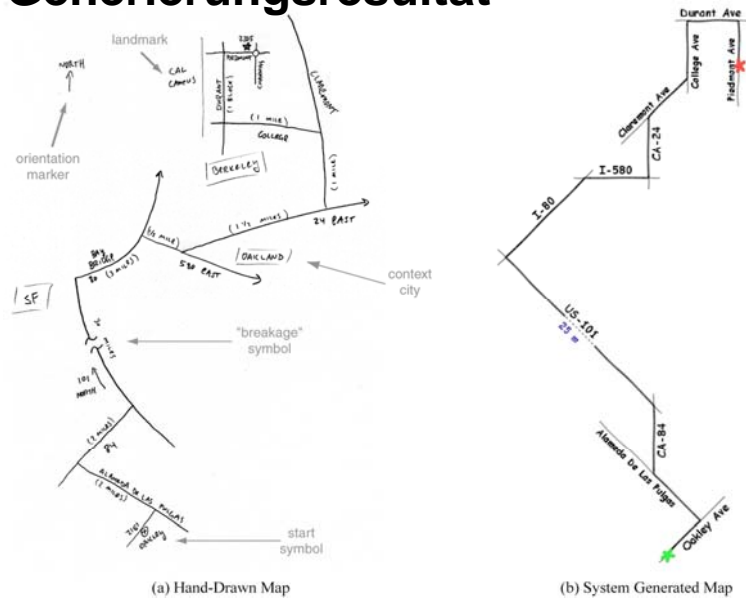

LMU München – Medieninformatik – Butz/Boring – Smart Graphics – SS2007 – Intro – Folie 15

Planbasierter Graphikdesigner

(André & Rist 1995)

- Generiert funktionelle Graphiken ausgehend von einem Präsentationsziel
- Benutzt allgemeine Designregeln und Wissen über die Domäne
- Realisiert Graphiken mithilfe gängiger Illustrationstechniken

LMU München – Medieninformatik – Butz/Boring – Smart Graphics – SS2007 – Intro – Folie 16

Beispiel aus WIP

Set the code switch S.4 to F in order to set for reception. Connect the plug of the telephone. Press the on/off switch in order to turn on the modem. The LED L.11 lights up after turning on the modem.

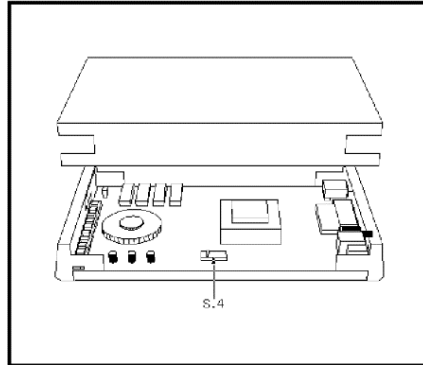

About the lecture & exercises

3 main parts of the lecture

- Motivations
 - Graphics & psychology
 - Graphics & arts & design
 - Graphics & communication
- Methods
 - A collection of AI tools and formalisms
 - How they can be applied to graphics
- Milestones
 - Examples from various fields

Exercises

- A few warm-ups in the beginning
 - Mainly about perception
- One major class project (in infoviz)
 - Base concept, criteria
 - Choice of tools
 - Implementation of a working demo
 - Documentation in the form of a research paper
- Groups of 2-4 students
- Final presentation at the end of the semester
 - Short talk explaining what and how
 - Demo of the implementation
 - Will be open to the public

Example student project: MusicVis (Blaine Boman, James Pak, Sajid Sadi, Columbia University)

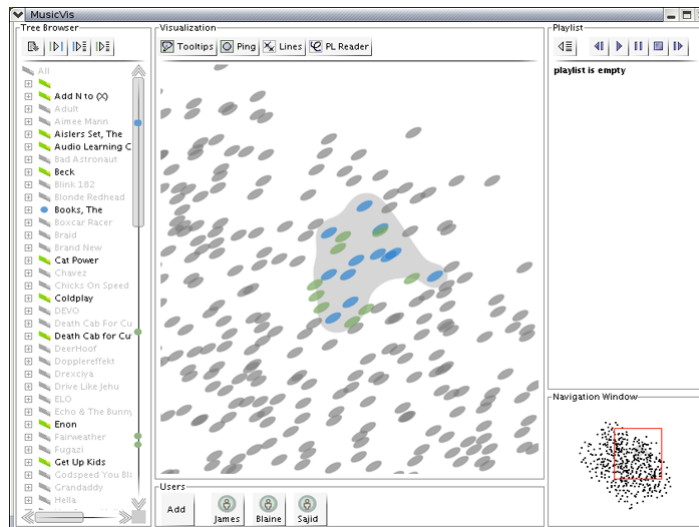

LMU München – Medieninformatik – Butz/Boring – Smart Graphics – SS2007 – Intro – Folie 21

MusicVis (cont'd)

- Visualization of MP3s in a starfield and a tree (coordinated displays)
- Mouse interaction with this visualization
- System learns which songs..
 - have been played closely together
 - are in the same playlist
- Formalism: Markov Model
 - Prediction of next song based on history
- <http://www1.cs.columbia.edu/~paley/spring03/assignments/HWFINAL/bgb10/>

LMU München – Medieninformatik – Butz/Boring – Smart Graphics – SS2007 – Intro – Folie 22

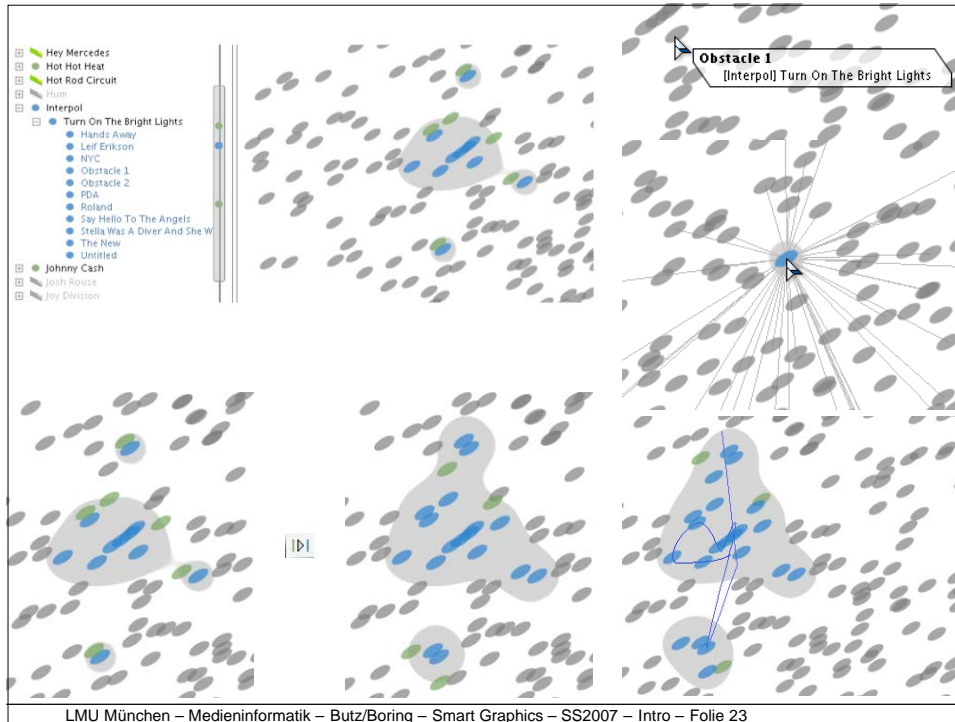

LMU Example (2005): Audio Radar

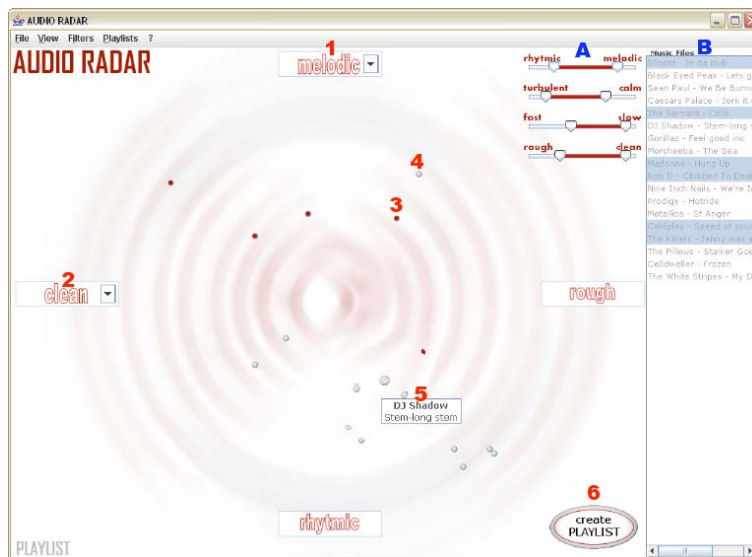

Some useful links

- <http://www.smartgraphics.org/>
- <http://www.cogsys.wiai.uni-bamberg.de/teaching/overview.html>
- <http://www1.cs.columbia.edu/~paley/spring03/>
- <http://www.cs.umd.edu/class/spring2005/cmsc838s>

- Exercises:
 - <https://wiki.medien.ifi.lmu.de/view/Main/UebungSmartGraphicsWS0506>

- Mailing list:
 - <https://tools.rz.ifi.lmu.de/mailman/listinfo/sg0506>